

REDDITCH BOROUGH COUNCIL

PROPOSED DIVERSIFICATION PARK DEVELOPMENT

LAND AT WINYATES GREEN TRIANGLE, REDDITCH

TRANSPORT ASSESSMENT

MT/NWK/VRG/835/HOC

NOVEMBER 2009

| Version | Detail | Prepared by | Checked by | Issued by |
|---------|-------------------|--------------------|-------------|--------------------|
| FINAL | CLIENT ISSUE 3 | V ROSS- GILMORE | B SMART | V ROSS- GILMORE |
| | SIGNATURE | | | |
| | DATE | NOV 2009 | NOV 2009 | NOV 2009 |

Morgan Tucker Ltd
AURA Commerce & Technology Centre
6 Manners Road
Newark
Notts
NG24 1BS

Tel 01636 610766
<http://www.morgantucker.co.uk>



INVESTOR IN PEOPLE

CONTENTS

| Chapter | | Page |
|---------|---|------|
| 1 | Introduction | 4 |
| 2 | Existing Site Information | 5 |
| 3 | Baseline Transport Data | 9 |
| 4 | Sustainable Transport Modes and Accessibility | 21 |
| 5 | Proposed Development | 29 |
| 6 | Impact Appraisal | 41 |
| 7 | Potential Mitigation Measures | 60 |
| 8 | Summary and Conclusions | 63 |

APPENDICES

| | |
|----------|--|
| A | Scoping Note |
| B | Location Plan (JN835-NWK-001) |
| C | Personal Injury Collision Data |
| D | 2009 Base Traffic Flows (JN835-NWK-002) ATC Speed Data A435 Birmingham Road ATC Speed Data Far Moor Lane Speed Survey Data A4023 Coventry Highway |
| E | Sustainable Transport Information: Pedestrian Catchment Area (JN835-NWK-003) Cycle Catchment Area (JN835-NWK-004) Public Transport Catchment Area (JN835-NWK-005) |
| F | Newark Beacon Multimodal Transport Survey (Business Innovation Centre use) TRICS Outputs (Business Park and Residential uses) Development Trip Assignment Diagrams: (JN835-NWK-006) - (JN835-NWK-008) |
| G | Traffic Distribution Diagrams: 2012 Without Development Traffic Flow Distribution (JN835-NWK-009) 2017 Without Development Traffic Flow Distribution (JN835-NWK-010) |
| H | ARCADY and PICADY Outputs Development Site Access Options: Far Moor Lane (JN835-NWK-011) A435 Birmingham Road (JN835-NWK-012A) A4023 Coventry Highway (JN835-NWK-013) LinSig Outputs |

1 INTRODUCTION

- 1.1 Morgan Tucker has been commissioned by Redditch Borough Council to investigate and advise on the transport and highways issues associated with a proposed diversification park on land sandwiched between the A4023 Coventry Highway and A435 Birmingham Road, and to produce a transport assessment which meets the requirements of both Worcestershire County Council and Warwickshire County Council.
- 1.2 The format and layout of this report take account of the latest transport assessment guidance, as issued by the Department for Transport in March 2007 and also Worcestershire and Warwickshire County Council's own policies and advice.
- 1.3 As recommended by national guidance, a scoping note was prepared in advance of the drafting of the full TA, in order to reach agreement with Worcestershire and Warwickshire County Councils, as highway authority for the town's internal road network, on the nature of the key issues to be examined in the report and various other technical parameters. The scoping note was mailed to Officers at both County Councils for comment.
- 1.4 Brian Sharp responded from Worcestershire County Council to confirm that the scoping note met his requirements and to draw our attention to Worcestershire County Council's TA Guidance Note. Warwickshire County Council failed to respond on the scoping note. A copy of the scoping note is included at **Appendix A**.
- 1.5 The transport assessment will provide supporting technical evidence to the overall planning appraisal process. Specifically, the report assesses the accessibility of the development site by a variety of modes of transport. The sustainability of the site is also considered with respect to relevant policy guidance and an assessment of the traffic impact of the proposal on the surrounding road network is provided and appropriate mitigation measures identified.

2 EXISTING SITE INFORMATION

2.1 Introduction

2.1.1 In order to assess the impact of the Diversification Park development proposal to be constructed on land at Winyates Green Triangle, Redditch, on the transport network surrounding the site, it has been necessary to establish the existing site conditions.

2.2 Site Location

2.2.1 A location plan (drawing number **JN835-NWK-001**) confirming the position of the development site within the context of the surrounding area is included in **Appendix B**.

2.2.2 The town of Redditch is situated approximately 15 miles south of Birmingham and is located on the northeastern boundary of Worcestershire. The town lies on the A435, which skirts to the east. The main route of access is the A441, which extends between Birmingham and Cookhill. The M42 motorway is a short drive away and it is linked by dual carriageways and A class roads to the surrounding towns of Bromsgrove and Evesham.

2.2.3 The town has a long history of successful manufacturing. In the 19th century, the town manufactured needles and diversified into fishing tackle, with other metal-based trades also growing in importance. Today 22.8% of jobs in Redditch are in the manufacturing sector, compared with 14% in the West Midlands and only 10.6% in Great Britain. The sector is crucial to the local economy.

2.2.4 Redditch was designated a New Town in 1964 and the population increased dramatically with the construction of housing developments such as Church Hill, Matchborough, Winyates, Lodge Park and Woodrow created to accommodate overspill from nearby areas such as Birmingham. Redditch was built as a flagship town using new methods and town planning, examples

of this innovation being that all the main roads are banked to reduce noise to the housing estates, with a network of footpaths and underpasses segregating pedestrians from primary routes.

2.2.5 According to the 2001 Census, Redditch has a population of approximately 78,800.

2.3 Existing Land Uses in the vicinity of the Development Site

2.3.1 The development site is situated on the Winyates Green Triangle on the northeastern boundary of Redditch, with a residential area to the west and south, the A435 Birmingham Road to the east, and the A4023 Coventry Highway to the north. **Plate 1** below highlights the proposed Diversification Park development in context.

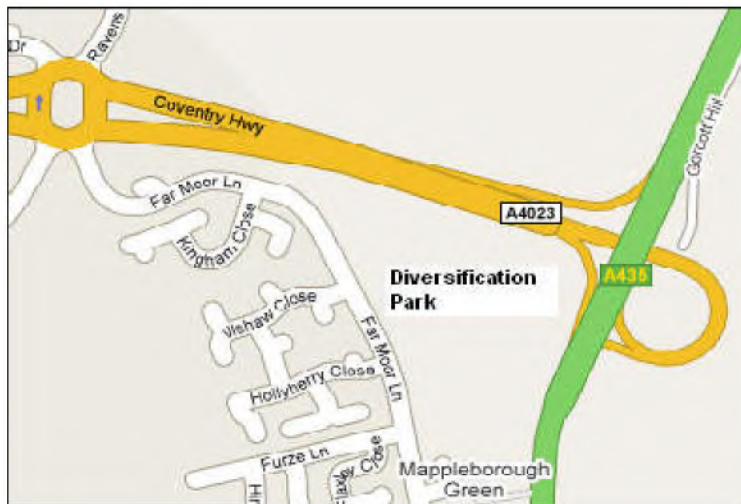

Plate 1 – Proposed Development Context

2.4 Existing use of the Development Site

2.4.1 The site is currently agricultural / unused. **Plate 2** refers:



Plate 2 – Development Site

2.5 Air Quality

- 2.5.1 Under the Environment Act 1995, local authorities are responsible for ensuring that air quality standards are not exceeded within their area after 2005. The National Air Quality Strategy sets standards for the eight main air pollutants and objectives for the UK.
- 2.5.2 Managing local air quality requires local authorities to identify and take action to tackle any local air quality problems from these pollutants. If conclusions point to objectives being exceeded, an Air Quality Management Area (AQMA) must be declared covering the area affected. Action plans must then be drawn up, involving the many different stakeholders, setting out how further objectives are to be achieved.
- 2.5.3 As part of this process, the local authority reviews and assesses local air quality on an annual basis and submits a report of their findings to DEFRA. In 2007 Redditch Borough Council published the 2007 Progress Report which indicated that none of the tested locations would exceed acceptable levels for pollutants. An extended diffusion tube survey took place in 2008 to monitor NO₂ levels and a further progress report was due in 2008 but is not on the website.

2.6 Abnormal Usage

- 2.6.1 The Construction and Use regulations provide the basic law by which normal motor vehicles and trailers (up to a maximum of 40 tonnes) are built and operate on the road. The movement of large or heavy loads and cranes (abnormal loads) that exceed dimensions set down by the regulations is permitted provide they follow the Special Types General Order (STGO) provided by the Department for Transport.
- 2.6.2 An abnormal load can potentially travel on any road provided the haulier complies with the law including weight limits; however, some roads are more suitable, such as A Class Roads. Before a haulier can move an abnormal load the Police must be notified. In addition if the gross weight or axle weights exceed those specified on the Construction and Use regulations the Highway Authority and bridge owners along the route must be informed e.g. Network Rail. The law requires a minimum of two days notice before moving the load.
- 2.6.3 At the present time no abnormal loads visit the site and this situation is unlikely to alter as a result of the development.

3 BASELINE TRANSPORT DATA

3.1 Introduction

3.1.1 This chapter firstly describes the character of the surrounding highway network and provides information on recent injury collisions recorded in the vicinity of the development site and baseline 2009 traffic flows from critical junctions in the town confirmed as being within the scope of the assessment.

3.2 Highway Network

3.2.1 The proposed development site is situated on land bounded by Far Moor Lane to the west, the A435 Birmingham Road to the east and the A4023 Coventry Highway to the north.

3.2.2 The A435 Birmingham Road is a de-trunked road, which links Birmingham and Cirencester. The section of the route to the east of the town is single lane carriageway with a 40 mph speed limit changing to a dual carriageway adjacent to the site and the junction with the A4023.

3.2.3 The A4023 Coventry Highway connects the eastern boundary of Redditch with the town centre where it forms the Redditch Ringway. The section of the route to the north of the development site is dual carriageway with a 70 mph speed limit. There is a well-used lay-by on this section of the road adjacent to the development site, along with a Route Information Point. **Plates 3 and 4** refer:



Plate 3 – Route Information Point adjacent to Development Site



Plate 4 – A4023 Coventry Highway adjacent to Development Site

3.2.4 Far Moor Lane runs between the A4023 Coventry Highway / Moons Moat North Industrial Estate roundabout and Alders Drive to the south. Far Moor Lane is a local distributor road with a 30 mph speed limit in place along its length. **Plate 5** refers:



Plate 5 – Far Moor Lane near to Development Site

3.3 Personal Injury Collision Statistics (PICS)

- 3.3.1 In order to confirm the safety record on the road network within the area of influence of the proposed development site, the personal injury collision statistics for the five year period from January 2004 to August 2009 have been obtained from Warwickshire and Worcestershire County Councils.
- 3.3.2 Analysis of the collision statistics confirms that since January 2004, there have been a total of 32 collisions within the search area surrounding the development site. **Tables 1** and **2** below identify the severity breakdown of these collisions and information on their locations on the road network.

| Category | Number of Collisions between January 2004 – August 2009 |
|----------|---|
| Slight | 29 |
| Serious | 2 |
| Fatal | 1 |

Table 1 - Collision Category

| Location | Number of Collisions | Percentage (%) |
|---|----------------------|----------------|
| Far Moor Lane | 3 | 9.4% |
| A4189 Warwick Highway / Alders Drive Roundabout inc. all approaches | 4 | 12.5% |
| A4023 Coventry Highway / Far Moor Lane Roundabout inc. all approaches | 11 | 34.4% |
| A435 Birmingham Road / A4023 Coventry Highway Junction inc. all approaches | 8 | 25% |
| A4189 Warwick Highway / A435 Birmingham Road Roundabout inc. all approaches | 3 | 9.4% |
| A435 Birmingham Road between the junction with A4023 Coventry Highway & A4189 Warwick Highway | 3 | 9.4% |

Table 2 – Location of Collisions

3.3.3 **Tables 1 and 2** above demonstrate that the vast majority of collisions which have occurred since 2004 resulted in slight injury. They are grouped into 6

locations, with 34.4% occurring on the approaches to or on the A4023 Coventry Highway / Far Moor Lane roundabout and 25% occurring on the approaches to or on the A435 Birmingham Road / A4023 Coventry Highway grade-separated junction. The next highest location with 12.5% was the A4189 Warwick Highway / Alders Drive roundabout and its approaches. Further details regarding the causes of these collisions are provided in **Tables 3 – 8** below:

| Collision Reference | Severity | Vehicles Involved | Cause |
|---------------------|----------|-------------------|---|
| 04DF39326 | Serious | HGV | Loss of control due to slippery carriageway surface |
| 06DF49456 | Slight | Car v. Car | Foreign National driving on the wrong side of the carriageway |
| 07DE86692 | Slight | Car v. Car | Failure to look properly and turned in to the path of an oncoming car |

Table 3 – Far Moor Lane

| Collision Reference | Severity | Vehicles Involved | Cause |
|---------------------|----------|--------------------|---|
| 04DF40432 | Slight | Car v. Pedal Cycle | Failure to look properly resulting in a car pulling in to the path of an oncoming pedal cyclist |
| 04DF41651 | Slight | Car v. Motorcycle | Car collided with the rear of a stationary motorcycle |
| 06DE50316 | Slight | Car v. Car | Car collided with the rear of a stationary car |

| | | | |
|-----------|--------|------------|--|
| 09D900988 | Slight | HGV v. Car | HGV collided with the rear of a stationary car |
|-----------|--------|------------|--|

Table 4 – A4189 Warwick Highway / Alders Drive Roundabout inc. all approaches

| Collision Reference | Severity | Vehicles Involved | Cause |
|---------------------|----------|-------------------|--|
| 04DF42068 | Slight | Car v. Taxi | Failure to look properly and turned in to the path of an oncoming taxi |
| 05DF48582 | Slight | HGV v. Car | HGV collided with the rear of a stationary car |
| 06DE49886 | Slight | Car | Loses Control for unknown reason |
| 06DE51627 | Slight | Car | Intoxicated car driver loses control of vehicle |
| 06DE52415 | Slight | Car v. Car | Collided with the rear of a stationary car |
| 06DE85255 | Slight | Car v. Car | Collided with the rear of a stationary car |
| 07DE86865 | Slight | Car v. Car | Loses control of vehicle whilst braking suddenly |
| 07DE87058 | Slight | Car v. Car | Collided with the rear of a car changing lane |
| 08DE88588 | Slight | Car v. Car | Collided with the rear of a stationary car |
| 09D903514 | Slight | Motorcycle | Loss of control whilst negotiating bend |

| | | | |
|-----------|--------|------------|--|
| 09D903977 | Slight | Car v. Car | Driving on the wrong side of the carriageway |
|-----------|--------|------------|--|

Table 5 – A4023 Coventry Highway / Far Moor Lane Roundabout inc. all approaches

| Collision Reference | Severity | Vehicles Involved | Cause |
|---------------------|----------|--------------------------|---|
| S031868 | Slight | Car | Loss of control whilst swerving to avoid another vehicle |
| S030658 | Slight | Car | Loss of control whilst overtaking |
| S031137 | Slight | Car v. Car | Intoxicated car driver loses control of vehicle |
| S031463 | Slight | Car v. Car v. Car v. Car | Collided with the rear of a stationary car in queuing traffic |
| S030250 | Slight | Car | Loses control whilst on slip road |
| S030603 | Serious | Car | Loss of control due to wet carriageway and excessive speed |
| S031558 | Slight | Motorcycle | Loss of control whilst overtaking |
| S031675 | Slight | Car v. Car | Loss of control due to icy carriageway |

Table 6 – A435 Birmingham Road /A4023 Coventry Highway Grade Separated Junction inc. all approaches

| Collision Reference | Severity | Vehicles Involved | Cause |
|---------------------|----------|-----------------------------|--|
| S032000 | Slight | Car v. Agricultural Tractor | Car collides with the rear of broken down tractor |
| S030959 | Slight | Car v. Car | Failure to look properly results in a car trying to overtake the other car turning right |
| S030834 | Fatal | Car v. Car v. Car | Loses control after exiting roundabout |

Table 7 – A4189 Warwick Highway / A435 Birmingham Road Roundabout inc. all approaches

| Collision Reference | Severity | Vehicles Involved | Cause |
|---------------------|----------|-------------------|--|
| S031383 | Slight | Car v. Car v. Car | Car collides with the rear of a car attempting u-turn |
| S031767 | Slight | Car v. Car | Car collides with rear of a car who has braked suddenly |
| S031707 | Slight | Car v. LGV. Car | Car collides with rear of stationary car who was waiting to turn right |

Table 8 – A435 Birmingham Road between A4023 Coventry Highway and A4189 Warwick Highway

3.3.4 Closer inspection of the interpreted listings reveals that the majority of collisions have occurred as a result of driver error for example, failing to look properly, following too closely and poor judgement. In addition, several of

these collisions occurred when the road conditions were wet/icy or there were objects in the carriageway.

3.3.5 One fatality occurred in the search area between 2004 and 2009, which occurred on 28 June 2008 at 1730 at the roundabout of A435 Birmingham Road and A4189 Warwick Highway. This occurred during the day, on a dry carriageway and in fine weather. The driver of the first car was travelling northwest bound on the A435 and exited the roundabout where they lost control, colliding with an oncoming southbound travelling car. A third car then collided with the rear of the second car as they were unable to stop in time. The driver of vehicle 1 aged 76 suffered fatal injuries.

3.3.6 Based on the information identified in the collision analysis, it is considered likely that the development proposals will not result in a statistically significant increase in the frequency or severity of collisions in the area surrounding the development site. The full listings from both authorities are contained in **Appendix C**.

3.4 Base Traffic Flows

3.4.1 In order to establish the 2009 base traffic flows on the A4023 Coventry Highway, a classified traffic survey was undertaken for the morning, afternoon and evening peak periods on the 8th September 2009. The data is contained in **Appendix D**.

3.4.2 In order to establish the 2009 base traffic flows on the A4189 Warwick Highway and Alders Drive / Far Moor Lane junction, a classified traffic survey was undertaken for the morning, afternoon and evening peak periods on the 9th September 2009.

3.4.3 In order to establish the 2009 base traffic flows on Far Moor Lane, an Automatic Traffic Counter (ATC) was laid between Wednesday the 9th September and Friday the 11th September 2009 between the junctions of Ilshaw Close and Hollyberry Close. **Plate 6** refers:



Plate 6 – Location of ATC on Far Moor Lane

3.4.4 Warwickshire County Council has provided ATC data for the A435 Birmingham Road (south of Gorcott Hill) from Monday the 1st June until Tuesday the 30th June 2009. This data includes vehicle count and speed survey information. **Plate 7** refers:



Plate 7 – Location of ATC on A435 Birmingham Road

3.4.5 The resulting 2009 peak hour base flows for the local road network are illustrated on the summary distribution diagram on drawing number **JN835-**

NWK-002 and the ATC data Speed Data for the A435 Birmingham Road and Far Moor Lane is contained in **Appendix D**.

3.5 Speed Data

- 3.5.1 In order to ascertain the speed of traffic travelling along Far Moor Lane, the A4023 Coventry Highway and the A435 Birmingham Road past the proposed development site, either a manual speed survey or ATC data was required. A manual speed survey was undertaken on the A4023 Coventry Highway on the 3rd September 2009, and the ATC data for Far Moor Lane and the A435 Birmingham Road was used to obtain speed survey information for those roads.
- 3.5.2 The 85th percentile speeds have been obtained in accordance with TA22/81 (Vehicle speed measurement on All Purpose Roads) of the Design Manual for Roads and Bridges.
- 3.5.3 With regards to the manual speed survey on the A4023 Coventry Highway, it was undertaken during neutral hours, i.e. non-peak hours, for a 2-hour period using a radar speed measurement gun. The enumerator was positioned in an unmarked car on the A4023 Coventry Highway so as not to affect traffic speeds and so that motorists were not aware of his presence. The weather was dry and sunny.
- 3.5.4 The speeds of 100 vehicles in a westbound direction were recorded in free flow conditions in order to obtain as accurate a sample as possible. The speeds were recorded as vehicles passed the speed survey point. As the sample size of the survey was less than 200 vehicles the standard deviation method of calculation was used to determine the 85th percentile speed.
- 3.5.5 The detailed survey results are attached at the rear of this report in **Appendix D** and the calculated 85th percentile speeds are confirmed in **Table 9 – 11** below:

| Direction of Traffic Flow | Dry Weather 85 th Percentile Speed | Wet Weather 85 th Percentile Speed |
|---|---|---|
| Westbound towards the Moons Moat roundabout | 63.09mph | 58.12mph |

Table 9 – Speed Survey Results – A4023 Coventry Highway

| Direction of Traffic Flow | Dry Weather 85 th Percentile Speed | Wet Weather 85 th Percentile Speed |
|---------------------------|---|---|
| Northbound | 44.73mph | 42.23mph |
| Southbound | 43.27mph | 40.77mph |

Table 10 – Speed Survey Results – Far Moor Lane

| Direction of Traffic Flow | Dry Weather 85 th Percentile Speed | Wet Weather 85 th Percentile Speed |
|---|---|---|
| Northbound towards the junction with the A4023 Coventry Highway | 44.6mph | 42.1mph |
| Southbound towards the junction with the A4189 Warwick Highway | 43.9mph | 41.4mph |

Table 11 – Speed Survey Results – A435 Birmingham Road

3.5.6 The speed survey results above show that vehicles in both directions are travelling in excess of the 30 mph speed limit along Far Moor Lane and in excess of the 40 mph speed limit along the A435 Birmingham Road. The higher speeds can be attributed to the inactive frontage on Far Moor Lane, lack of pedestrian activity or parked cars, and on the A435 Birmingham Road this can be attributed to the nature of the road and again its largely inactive frontage.

3.6 Existing Trip Generation

3.6.1 The site is currently agricultural / unused and is generating minimal trips.

4 SUSTAINABLE TRANSPORT MODES AND ACCESSIBILITY

4.1 Introduction

4.1.1 This chapter discuss in detail access to the development by sustainable modes of travel and how this could be improved through the use of a Travel Plan.

4.2 Pedestrian and Cycling Facilities

4.2.1 Walking and cycling have significant roles to play in delivering a more sustainable transport system. Nearly a quarter of all car driver trips are less than 2 miles and 56 per cent are less than 5 miles (DfT, 2008). For some of these journeys, walking and cycling can be a real alternative. Not only does this help reduce congestion and pollution, but it can also improve our health and wellbeing and reduce obesity.

4.2.2 PPG13 (paragraph 75) identifies walking as being “the most important mode of travel at the local level and offers the greatest potential to replace short car trips, particularly under 2 kilometres.”

4.2.3 The Institution of Highways and Transportation (IHT) publication ‘Guidelines for providing for journeys on foot’ (2000) provides guidance on how to encourage pedestrian travel. Within paragraph 3.3.1 it identifies the following factors as being the main influence on acceptable walking distances: -

- An individual’s fitness and physical ability
- Encumbrances, e.g. shopping pushchair
- Availability, cost and convenience
- Time savings
- Journey purpose
- Personal Motivation
- General deterrents to walking

4.2.4 The Guidelines also note that walking accounts for over a quarter of all journeys and four-fifths of journeys less than one mile, (1.6 kilometres). Furthermore, walking is also an essential part of much car and almost all public transport travel, as bus stops are usually accessed on foot. The promotion of sustainable, integrated transport therefore involves providing good pedestrian links to public transport facilities. A drawing is contained in **Appendix E (JN835-NWK-004)** which demonstrates the area accessible within a comfortable 2 kilometre walk distance of the site.

4.2.5 A footpath is adjacent to the development site on Far Moor Lane and forms a continuous wide path of approximately 2 metres behind a 9.5 metre wide highway verge. There is regular street lighting, along with interconnecting underpasses (approximately 3.8 metres wide) under Far Moor Lane into the neighbouring residential estate. **Plates 8 - 10** refer:



Plate 8 – Footpath on Far Moor Lane



Plate 9 – Typical underpass under Far Moor Lane



Plate 10 – Typical linkage into neighbouring residential estate

4.2.6 PPG13 (paragraph 78) identifies cycling as having “the potential to substitute for short car trips, particularly those under 5km, and to form part of a longer journey by public transport.” A drawing is contained in **Appendix E (JN835-NWK-005)** which demonstrates the area accessible within a comfortable 5 kilometre cycle distance of the site.

4.2.7 Redditch’s urban road infrastructure is conducive to cycling, with its network of residential roads and footpath/underpass connections bypassing busier

roads. However the area would benefit from pedestrian/cycle signage to encourage the use of these sustainable modes of travel.

4.2.8 Redditch is on the National Cycle Network Routes 5 and Regional Route 55. NCN5 is a long distance route which when complete will connect Reading and Holyhead via Oxford, Banbury, Stratford-upon-Avon, Redditch, Bromsgrove, Birmingham, Walsall, Stafford, Stoke-on-Trent, Chester, Colwyn Bay and Bangor. NCN55 is a regional route linking Redditch to Kings Norton in the West Midlands. **Plate 11**, courtesy of Worcestershire County Council's LTP2, refers:

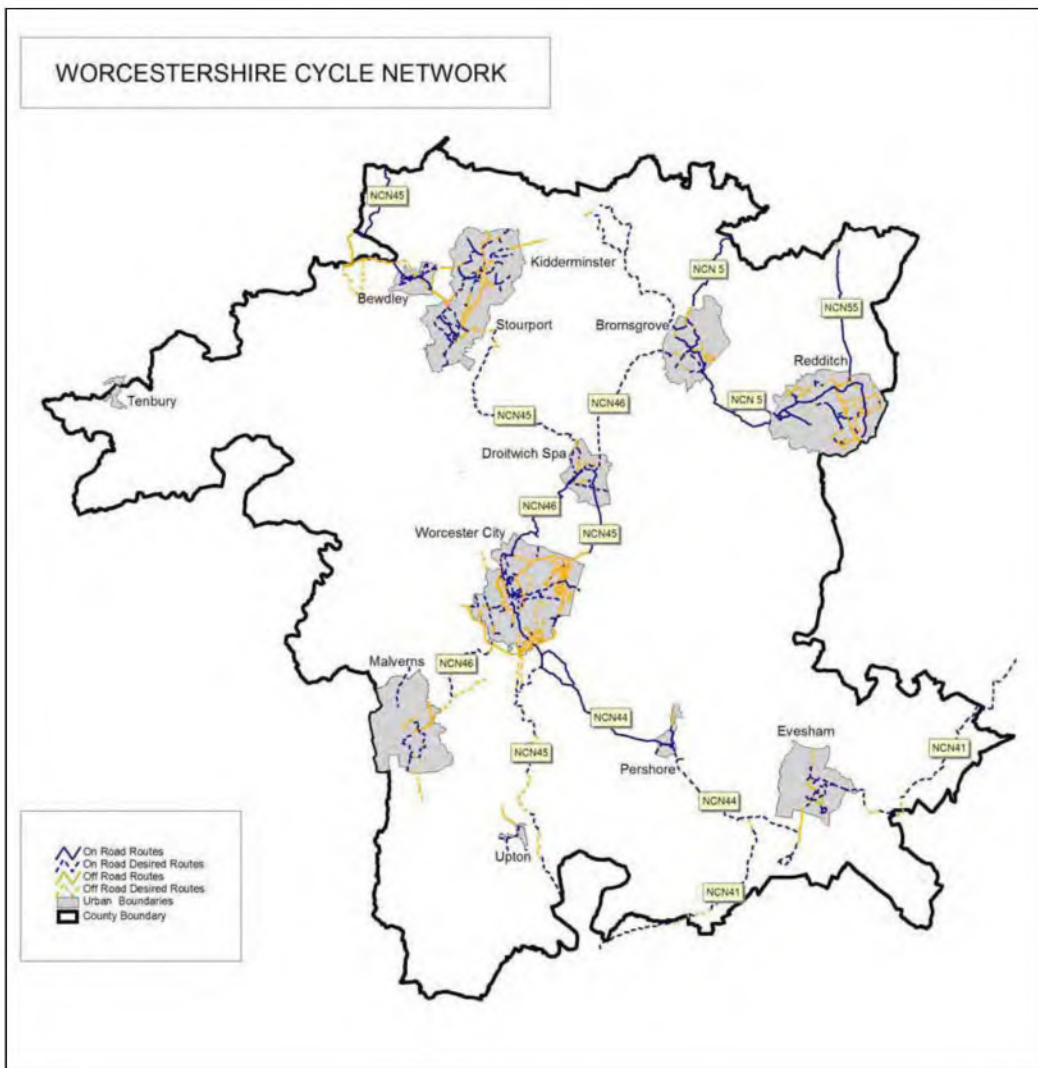

Plate 11 – Worcestershire Cycle Network

4.2.9 It is proposed that the development will provide undercover cycle parking to meet local standards.

4.3 Passenger Transport Facilities - Bus

4.3.1 An assessment of the existing bus facilities within the vicinity of the proposed development has been undertaken following a site visit on the 3rd September 2009.

4.3.2 The development site is well located for access to public transport with bus stops within comfortable walking distance of the proposed site access on Far Moor Lane. The nearest bus stops are near Illshaw Close and Furze Lane, which are located less than 20 metres from the potential vehicular access to the development site and approximately 200 metres apart from one another. A drawing (**JN835-NWK-006**) is contained in **Appendix E** which confirms the bus stop infrastructure within a 400-metre walk distance of the site.

4.3.3 The bus stops both consist of hard standing, a post, with a flag and timetable information attached. In addition, the Furze Lane stop is linked to the footpath adjacent to the development site by a further footpath. **Plates 12** and **13** refer:



Plate 12 – Near Illshaw Close, Far Moor Lane



Plate 13 – Near Furze Lane, Far Moor Lane

4.3.4 An assessment of the existing bus services within the vicinity of the proposed development has been undertaken, and route and timetable information has been obtained courtesy of the Worcestershire County Council website. All bus timetables and routes operating along Far Moor Lane e.g. within 400 metres of the development site are summarised in **Tables 9 - 10** below.

4.3.5 Services 52 and 53 are circular routes operating along Far Moor Lane, hourly Monday to Saturday.

| | Direction/Route/Operator | Frequency of Service | | |
|--------------------------|---|----------------------|-------------------------------------|---------|
| | | Morning | Daytime | Evening |
| Monday - Saturday | Redditch - Church Hill - Matchborough East - Alexandra Hospital - Winyates West - Riverside - Redditch 52 First | 0906 | 1006 1106 1206 1306 1406 1506 | |

| | | | |
|-------------------------|--|--------------------------------|--|
| Monday- Saturday | Redditch - Riverside - Winyates West - Alexandra Hospital - Matchborough East - Church Hill - Redditch | 1004 1104 1204 1304 1404 | |
| | 53 | | |
| | First | | |

Table 9 – Services 52 and 53, Far Moor Lane

4.3.6 Service 61 is a circular route operating along Far Moor Lane, hourly Monday to Saturday.

| | Direction / Route | Frequency of Service | | |
|--------------------------|--|-----------------------------|---|----------------|
| | | Morning | Daytime | Evening |
| Monday - Saturday | Sainsbury's - Redditch - Winyates Green - Matchborough East (Circular) 61 Diamond | 0804 0854 | 1014 1114 1214 1314 1414 1514 1614 | 1714 1804 |

Table 10 – Service 61, Far Moor Lane

4.3.7 The contents of the above tables were correct at the time of printing and clearly illustrate that there are already frequent opportunities for travel around Redditch by bus.

4.4 Travel Plan

4.4.1 A Travel Plan is a specific package of measures tailored to suit the needs of individual sites aimed at promoting greener, cleaner travel choices and reducing single occupancy car journeys.

4.4.2 The objectives for the Business Travel Plan would be to enable modal choice for visitors to the site and to reduce single occupancy car trips associated with the site. It would address commuter journeys and business journeys. For

example, measures could include an information pack for visitors with bus timetables.

- 4.4.3 The Travel Plan would include a range of mechanisms, initiatives, targets, indicators and associated monitoring/review procedures to reduce the impact of travel associated with the site on the environment. For example, it would be likely to include targets to encourage the use of local bus services.

5 PROPOSED DEVELOPMENT

5.1 Introduction

5.1.1 This chapter will discuss in detail the proposed development site and the impact of new trips generated by the development.

5.2 Proposed Development

5.2.1 The proposal is to create a Diversification Park to facilitate businesses in Redditch by manufacturing new products for growth sectors or finding alternative markets for their current products. The businesses themselves would not locate on the diversification park; rather they would use the facilities on the park to help develop their new products. The park should be a central facility for manufacturers to access support and services specifically designed to meet their needs. These could include:

- Manufacturing Advisory Service
- Other Business Link Services
- Proto-typing companies
- Solicitors specialising in patent and intellectual property rights
- Incubator units
- Market research companies
- CAD/CAM specialists

5.2.2 The Park would also be a host location for regular events such as:

- International trade events
- Meet the buyer events
- Meet your maker events

5.3 Proposed Parking

5.3.1 Car parking spaces will be provided in accordance with government guidance, and specific local guidance.

5.3.2 Cycle parking spaces will be provided in accordance with government guidance, and specific local guidance.

5.4 Trip Generation

Diversification Park / Business Innovation

5.4.1 In order to derive the potential level of new trips that would be generated by the proposed development, the TRICS 2009 database has been interrogated, however, in the absence of comparable survey sites, Morgan Tucker conducted our own multimodal transport survey at a local site which was considered to be comparable.

5.4.2 Newark Beacon is a state of the art business innovation centre approximately 2000 sqm, completed in 2007 to offer 27 office units, along with 4 light industrial units, additional support facilities, virtual office facilities, conference facilities, and a café. Although smaller than the proposed Diversification Park, the survey results were factored accordingly.

5.4.3 Full results of the survey of Newark Beacon are contained in **Appendix F**.

5.4.4 The resulting trip generations (factored up for a 10,000 sqm development) are in **Table 11** below:

| Use | AM Peak Hour (08:00 – 09:00) | | PM Peak Hour (17:00 – 18:00) | |
|--|------------------------------|------------|------------------------------|------------|
| | Arrivals | Departures | Arrivals | Departures |
| Business Innovation Centre - Vehicles | 205 | 20 | 25 | 160 |
| Business Innovation Centre - Pedestrians | 50 | 5 | 0 | 5 |
| Business Innovation | 15 | 0 | 5 | 5 |

| | | | | |
|----------------------|--|--|--|--|
| Centre - Cyclists | | | | |
|----------------------|--|--|--|--|

Table 11 – Proposed Trip Generations 10,000 sqm Business Innovation Centre

5.4.5 To summarise, the proposed development would generate a worst case of 225 2-way trips in the AM peak hour and 185 2-way trips in the PM peak hour for 10,000 sqm business innovation development.

5.4.6 The resulting trip generations (factored up for a 20,000 sqm development) are in **Table 12** below:

| Use | AM Peak Hour (08:00 – 09:00) | | PM Peak Hour (17:00 – 18:00) | |
|--|------------------------------|------------|------------------------------|------------|
| | Arrivals | Departures | Arrivals | Departures |
| Business Innovation Centre - Vehicles | 410 | 40 | 50 | 320 |
| Business Innovation Centre - Pedestrians | 100 | 10 | 0 | 10 |
| Business Innovation Centre - Cyclists | 30 | 0 | 10 | 10 |

Table 12 – Proposed Trip Generations 20,000 sqm Business Innovation Centre

5.4.7 To summarise, the proposed 20,000 sq.m business innovation development would generate a worst case of 450 two-way trips in the AM peak hour and 370 two-way trips in the PM peak hour.

Business Park

5.4.8 For a further comparison, the TRICS 2009 database has been interrogated for Business Parks to provide a statistically valid estimate of the likely rate of trip generation (full information contained in **Appendix F**). In addition, a

modal split pie chart is contained below to illustrate the division of trips via mode. **Plate 14** refers:

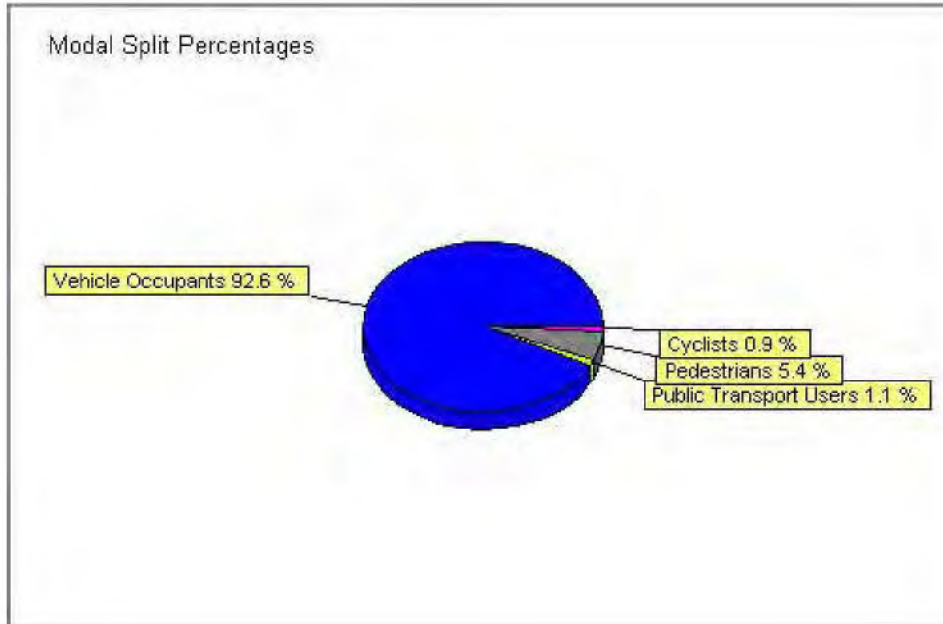

Plate 14 – Business Park

5.4.9 The resulting trip generations are displayed below in **Table 13**:

| Use | AM Peak Hour (08:00 – 09:00) | | PM Peak Hour (17:00 – 18:00) | |
|--|------------------------------|------------|------------------------------|------------|
| | Arrivals | Departures | Arrivals | Departures |
| Per 100 sqm | 1.364 | 0.286 | 0.235 | 1.186 |
| Business Park – Vehicles | 136 | 29 | 23 | 119 |
| Business Park – Pedestrians | 10 | 1 | 2 | 8 |
| Business Park – Cyclists | 2 | 0 | 0 | 1 |
| Business Park – Public Transport Users | 4 | 0 | 0 | 2 |

Table 13 – Proposed Trip Generations 10,000 sqm Business Park

5.4.10 To summarise, the proposed development would generate a worst case of 165 2-way trips in the AM peak hour and 142 2-way trips in the PM peak hour for 10,000 sqm business park development.

5.4.11 The resulting trip generations are displayed below in **Table 14**:

| Use | AM Peak Hour (08:00 – 09:00) | | PM Peak Hour (17:00 – 18:00) | |
|--|------------------------------|------------|------------------------------|------------|
| | Arrivals | Departures | Arrivals | Departures |
| Per 100 sqm | 1.364 | 0.286 | 0.235 | 1.186 |
| Business Park – Vehicles | 273 | 57 | 47 | 237 |
| Business Park – Pedestrians | 21 | 1 | 4 | 17 |
| Business Park – Cyclists | 5 | 0 | 0 | 3 |
| Business Park – Public Transport Users | 8 | 0 | 0 | 4 |

Table 14 – Proposed Trip Generations 20,000 sqm Business Park

5.4.12 To summarise, the proposed development would generate a worst case of 330 two-way trips in the AM peak hour and 284 two-way trips in the PM peak hour for 20,000 sqm business park development.

Residential Development

5.4.13 Lastly, in early 2000, the development site was investigated for a 300 house residential development. For accuracy, the TRICS 2009 database has been re-interrogated for Residential Development to provide an up-to-date estimate of the likely rate of trip generation (full information contained in **Appendix F**). In addition, a modal split pie chart is contained below to illustrate the division of trips via mode. **Plate 15** refers:

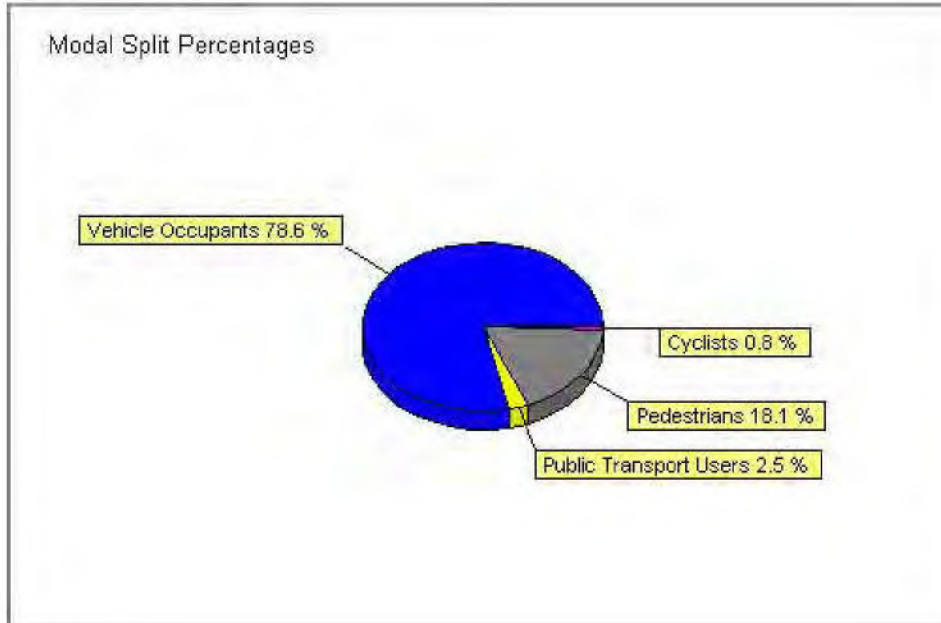

Plate 15 – Residential Development

5.4.14 The resulting trip generations are displayed below in **Table 15**:

| Use | AM Peak Hour (08:00 – 09:00) | | PM Peak Hour (17:00 – 18:00) | |
|--|------------------------------|------------|------------------------------|------------|
| | Arrivals | Departures | Arrivals | Departures |
| Per Dwelling | 0.223 | 0.469 | 0.439 | 0.309 |
| 300 Residential Dwellings – Vehicles | 67 | 141 | 132 | 93 |
| 300 Residential Dwellings – Pedestrians | 15 | 72 | 27 | 19 |
| 300 Residential Dwellings – Cyclists | 3 | 2 | 0 | 1 |
| 300 Residential Dwellings – Public Transport Users | 12 | 13 | 4 | 1 |

Table 15 – Proposed Trip Generations 300 Residential Dwellings

5.4.15 To summarise, the proposed 300 dwelling residential development would generate a worst case of 208 two-way trips in the AM peak hour and 225 two-way trips in the PM peak hour.

Conclusion

5.4.16 As demonstrated above, the worst case for trip generation is a business innovation use with 20,000 sqm generating 450 two-way trips in the AM peak hour and 370 two-way trips in the PM peak hour.

5.5 Census Data

5.5.1 The 2001 Census holds the most up-to-date source of data about the population of Redditch, which can be used to check that the trip generations and modal splits we are proposing for this development site are appropriate. The Redditch map is contained in **Plate 16** below:

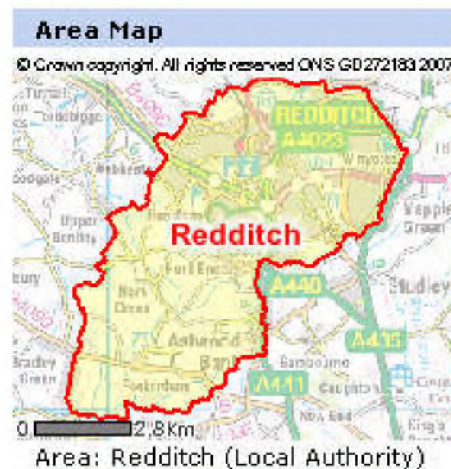

Plate 16 – Census Redditch Area

5.5.2 According to the 2001 Census Data, car ownership in Redditch is higher than in the West Midlands as a whole, with only 21% of households without a car compared to 27% for the West Midlands. 42% of households have 1 car in Redditch compared to 43% in West Midlands, and 37% have 2 or more cars compared to 30% in the West Midlands. **Plates 17** and **18** below illustrate:

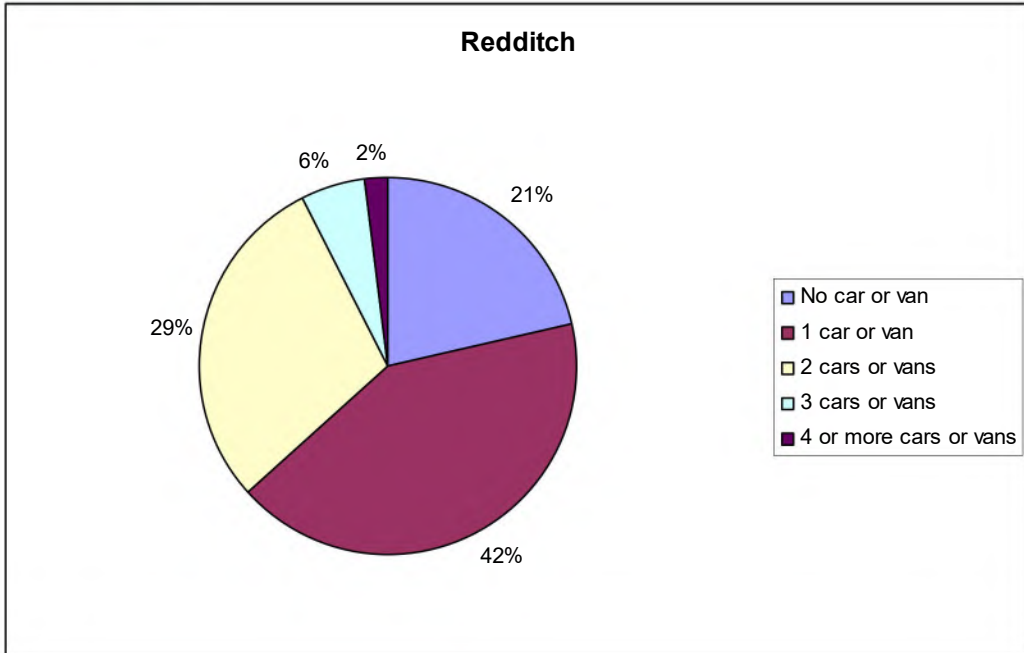

Plate 17 – Car ownership per household in Redditch (2001 Census)

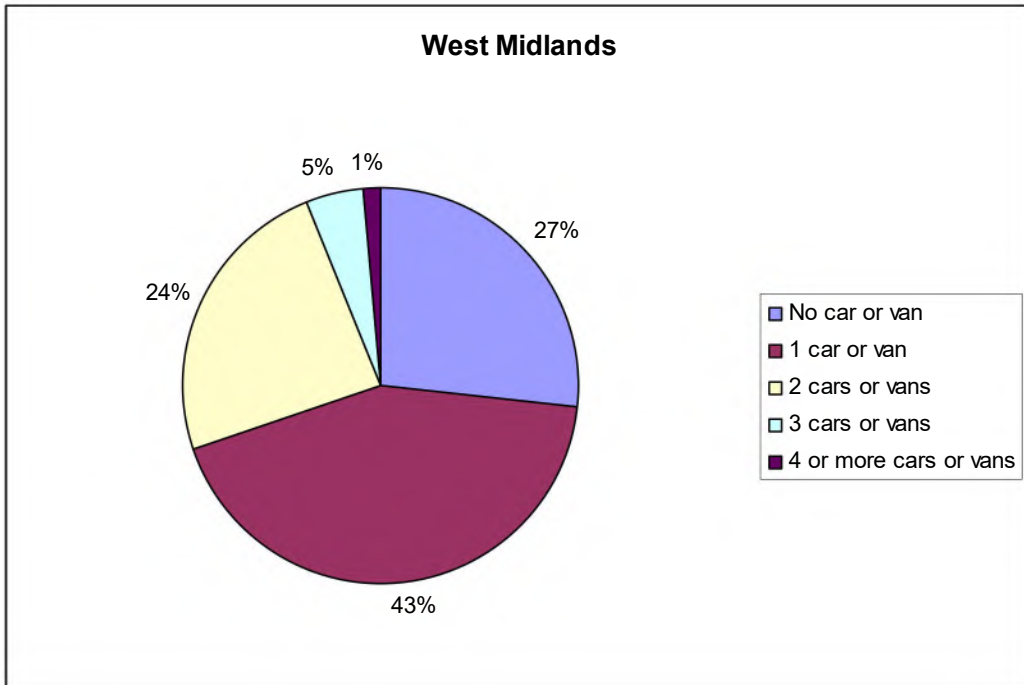

Plate 18 – Car ownership per household in the West Midlands (2001 Census)

5.5.3 The impact of car ownership in Redditch is illustrated in **Plate 19** below where car use is by far the most popular mode of travel, with 70% of journeys to

work made by people driving a car, and a further 8% as a passenger in a car, in employment in the Redditch area. The percentage of people who travel to work via a sustainable mode of transport such as walking, cycling, and public transport is 9%, 2% and 10% respectively, providing a total of 21% of all journeys.

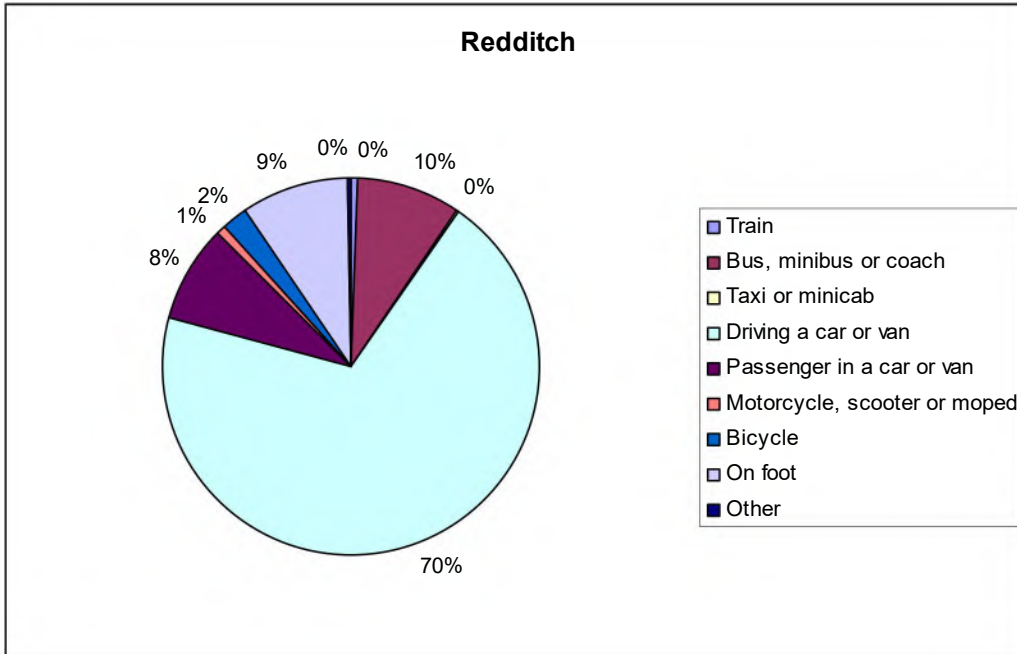

Plate 19 – Travel to Work by Mode in Redditch (2001 Census)

5.5.4 **Plate 20** below demonstrates that the car is slightly less dominant with 67% of people employed in the West Midlands travelling to work made by people driving a car, and a further 8% as a passenger in a car. In turn, the percentage of people who use sustainable travel modes has increased to 24% of the modal split (10% walking, 2% cycling, 12% public transport).

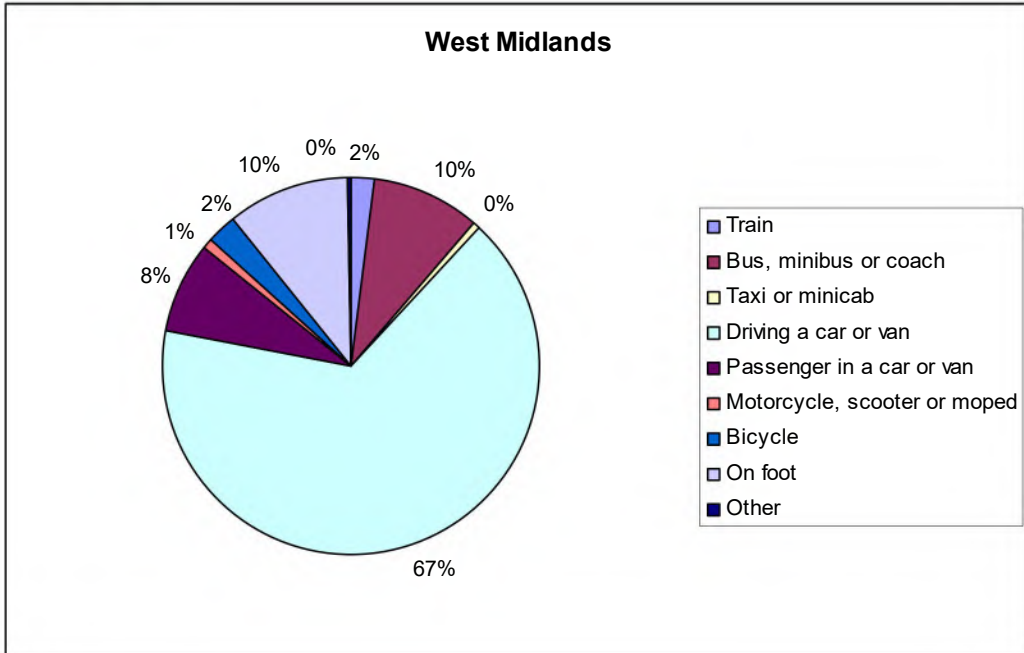

Plate 20 – Travel to Work by Mode in the West Midlands (2001 Census)

5.5.5 **Plate 21** below demonstrates that 28% of journeys to work in Redditch are less than 2 km, a comfortable walking distance, and 33% are between 2 and 5 km, so comfortable cycling or public transport distance.

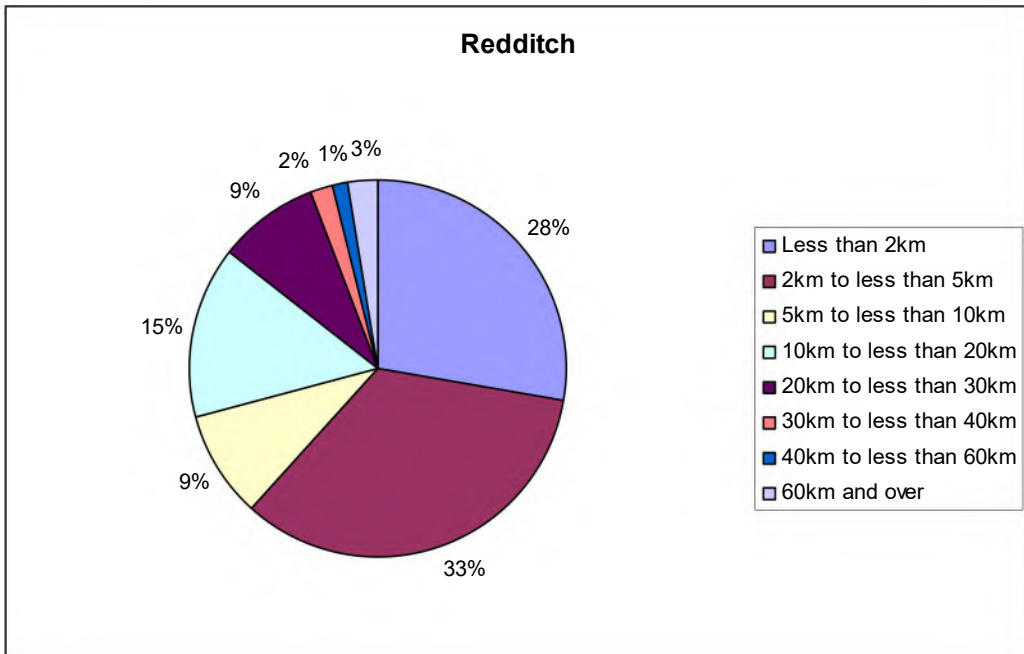

Plate 21 - Distance Travelled to Work in Redditch (2001 Census)

5.5.6 In comparison, **Plate 22** below demonstrates that 23% of journeys to work in the West Midlands are less than 2 km and 26% of journeys are between 2 and 5 km.

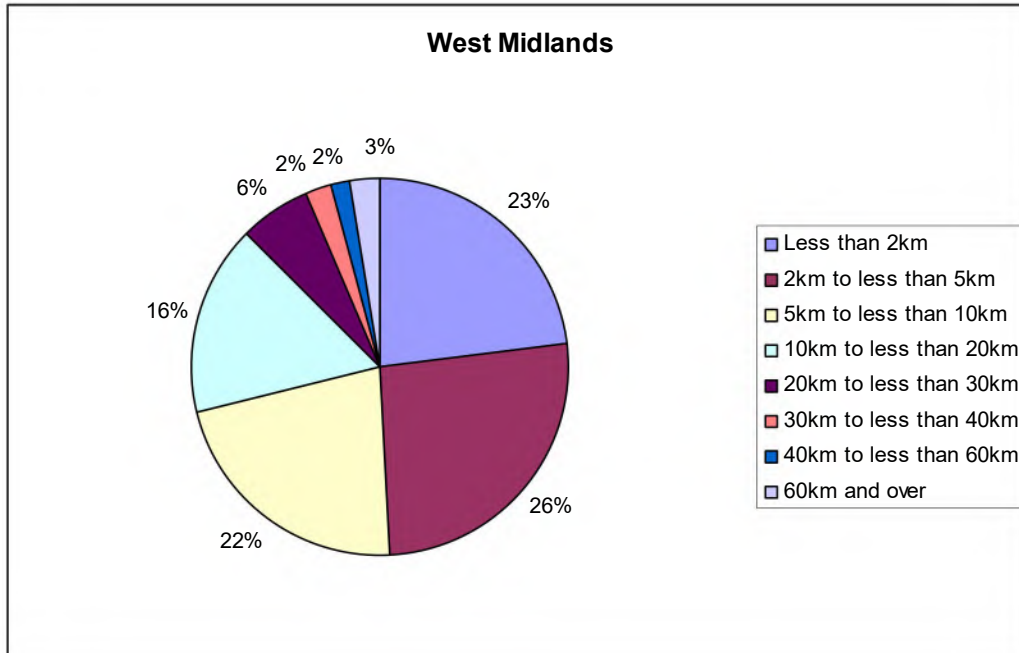

Plate 22 - Distance Travelled to Work in the West Midlands (2001 Census)

Conclusion

5.5.7 From the investigations above into the 2001 Census data for Redditch and the West Midlands, it is likely that approximately 75-78% of trips generated by the proposed development site will be by car with sustainable travel modes comprising the remaining 22-25%. This is a similar level to the results of the TRICS investigations, therefore it is acceptable to use these surveys for estimating the likely trip generations on the local highway network.

5.6 Trip Distribution

5.6.1 Following the investigation into the 2001 Census Data for Redditch, it is still not clear what the likely origin and destinations will be of the trips generated to/from the proposed development. Development trip distribution diagrams

(JN835-NWK-006 – JN835-NWK-008) illustrating the likely assignment of the development traffic are attached at **Appendix F**.

6 IMPACT APPRAISAL

6.1 Introduction

6.1.1 This chapter will discuss in greater detail the likely impact of the proposed development site as measured against the government's five objectives for transport (outlined in A New Deal for Transport and A New Deal for Trunk Roads White Papers), applied through the New Approach to Appraisal (NATA).

6.2 Environment

6.2.1 In 2007 Redditch Borough Council published the 2007 Progress Report which indicated that none of the tested locations would exceed acceptable levels for pollutants. An extended diffusion tube survey took place in 2008 to monitor NO₂ levels and a further progress report was due in 2008 but is not on the website.

6.2.2 In terms of environmental impact of the development, the proposal will result in the generation of motorised vehicle trips. However the subsequent improvement of accessibility through the use of an innovative travel plan and other necessary transport improvements to provide new linkages such as improvements to public transport, would mediate the impact.

6.3 Safety

6.3.1 In order to confirm the safety record on the road network within the area of influence of the proposed development site, the personal injury collision statistics for the five year period from January 2004 to August 2009 have been obtained from Warwickshire and Worcestershire County Councils.

6.3.2 Analysis of the collision statistics confirms that since January 2004, there have been a total of 32 collisions within the search area. Inspection of the interpreted listings reveals that the majority of collisions have occurred as a result of driver error for example, failing to look properly, following too closely and poor judgement. In addition, several of these collisions occurred when the road conditions were wet/icy or there were objects in the carriageway.

6.3.3 Based on the information identified in the collision analysis, it is considered likely that the development proposals will not result in a statistically significant increase in the frequency or severity of collisions in this area of Redditch.

6.4 Economy

6.4.1 One of the key roles of the planning system is to ensure that sufficient and attractive land is available for employment related development. The Borough Council has recently prepared a Draft Employment Land Review (October 2008) as part of its Local Development Framework that it is currently progressing. The purpose of the Review is to provide a context for the Local Development Framework by establishing future employment sites. The Review examines existing employment sites in terms of their fitness for future employment use, and identifies new sites for future use.

6.4.2 **Plate 23** below demonstrates that out of the people in Redditch who are of an economically active age; 65% are employed full-time, 17% part-time, 10% are self-employed, 3% are full-time students and 5% unemployed.

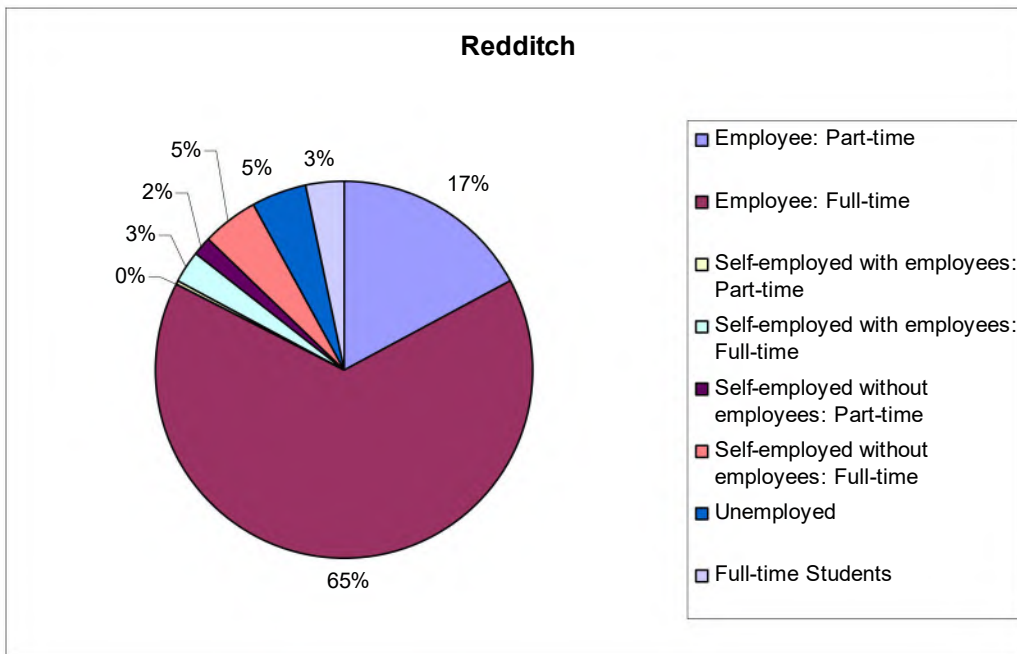

Plate 23 – Economic Activity in Redditch (2001 Census)

6.4.3 **Plate 24** demonstrates that the largest percentage of people (29%) work in manufacturing, followed by wholesale and retail trade / motor vehicles (19%), real estate (12%), health and social work (9%). Please note, there are very small percentages of people working in agriculture, hunting, forestry, fishing, mining and quarrying, electricity, gas, and water supply, which are not reflected on **Plate 24**.

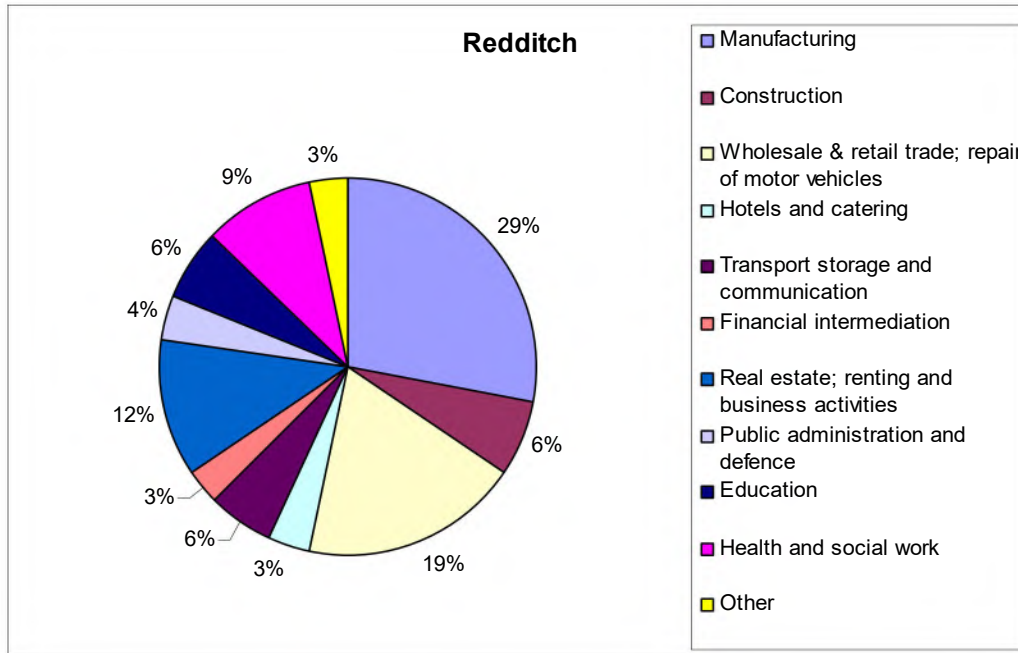

Plate 24 – Employment Industry in Redditch (2001 Census)

6.4.4 The results in **Plate 24** above for manufacturing concur with Redditch Borough Council’s desire for a Diversification Park to support manufacturers and individuals, and the manufacturing industry in Redditch.

6.5 Accessibility

6.5.1 Worcestershire’s second Local Transport Plan for 2006-11 (LTP2) was published in March 2006. The LTP2 outlines the transport strategy for Worcestershire for a five year period ending March 2011, and provides details of priority projects for the improvement of transport within Worcestershire. The overall vision of the LTP2 strategy is “To deliver a transport system within Worcestershire that is safe to use, and which allows people to easily access

the facilities that they need for their day-to-day life in a sustainable and healthy way.”

6.5.2 The Worcestershire LTP2 has the following relevant transport strategies which have been developed following analysis of transport issues within the context of the wider priorities for the County and are underpinned by the four shared Priorities for Transport :

- To ensure that all residents, visitors and workers in Worcestershire can access the facilities they need to carry out day-to-day activities by the safest, most efficient and convenient mode of transport available to them.
- To minimise the impact of all modes of transport upon the local environment, and seek to reduce vehicle emissions arising from transport activity within Worcestershire.
- To ensure that traffic congestion within Worcestershire does not constrain economic activity within the County, reduce the impact of congestion upon local communities, and ensure that the environmental impact of congestion is minimised.
- To create a transport network within Worcestershire that is even safer for people to use.
- To ensure that land use decisions take full account of transport issues and that community facilities are located to minimise the need for travel for their users.

6.5.3 The Worcestershire LTP2 contains the Accessibility Strategy which covers a wide range of transport modes as well as the need to ensure the accessibility of facilities is considered when land use decisions are made. The vision for the accessibility strategy is “To ensure that people have access to key services at reasonable cost, in reasonable time, and with reasonable ease, and in a way that promotes better health for all.” It is outlined within the plan that implementing the accessibility strategy will involve improving walking, cycling, passenger transport, and public rights of way facilities across the County and involve partnership working.

6.5.4 Warwickshire County Council developed a second Local Transport Plan, LTP, which sets out how the County Council plans to improve transport in

Warwickshire over the five year plan period. The plan was adopted in March 2006, following a review of the previous LTP 2001-06, and covers the five year period ending 31 March 2011. The plan provides the policy background and planning to how local transport services contribute towards improving peoples and lives and making Warwickshire ‘the best place to live and work’.

6.5.5 The Warwickshire LTP2 has specific transport objectives which have been developed within the context of the wider priorities for the County and are underpinned by the four shared Priorities for Transport:

- Accessibility: to improve accessibility to health and educational facilities;
- Road Safety: to maintain a special focus on improving road safety for children, particularly in disadvantaged areas;
- Congestion: to discourage traffic growth during peak periods in urban areas; and
- Air Quality: to tackle the declared Air Quality Management Areas (AQMAs) and prevent any further areas being declared.

6.5.6 It is outlined within the LTP2 Warwickshire County Council’s intentions to place the strongest emphasis on addressing issues of accessibility and continuing to make roads safer. It is also acknowledged as pressure on transport networks in the urban areas of Warwickshire increase the issues of air quality and congestion need to be addressed.

6.5.7 The Warwickshire LTP2 contains the Accessibility Strategy. The Accessibility Strategy has close links to national, regional and local policy frameworks. The vision for the accessibility strategy is ‘to enable people to reach a range of education, training, employment, healthcare, shopping and leisure opportunities, with a particular focus on improving accessibility for disadvantaged groups and areas.’ The Accessibility Strategy ensures that its action plans positively encourage sustainable travel patterns and opportunities available for walking cycling and passenger transport as priorities to maximize the ability to connect people to jobs, key services, and public transport.

6.6 Policy Integration

Planning Policy Statement 1

6.6.1 Planning Policy Statement 1: Delivering Sustainable Development (PPS1) states that 'Planning should facilitate and promote sustainable and inclusive patterns of urban and rural development'. It is thought that this proposal is in support of PPS1 as it supports the following aims:

- the promotion of urban and rural regeneration...and create new opportunities for the people living in those communities.
- bring forward sufficient land of a suitable quality in appropriate locations to meet the expected needs for housing, for industrial development, for retail and commercial development, and for leisure and recreation.
- provides improved access for all to jobs, health, education, shops, leisure and community facilities, open space, sport and recreation.

Planning Policy Guidance Note 13

6.6.2 The development proposal will also fully support the objectives of Planning Policy Guidance Note 13: Transport (PPG13) through the integration of planning land use and transport in order to help reduce the growth in the length and number of motorised journeys and encourage alternative modes of travel to the private motor vehicle. In particular, this will include the use of an innovative travel plan.

Regional Planning Guidance

6.6.3 The West Midlands Regional Spatial Strategy (RSS) Phase 2 Revision (Preferred Option) identifies Redditch as a Settlement of Significant Development. The level of housing growth for the period 2006-2026 is identified as 6,600 dwellings, 3,300 of which need to be accommodated on land within the adjoining authorities of Bromsgrove District Council and Stratford District Council, but adjacent to the boundary of Redditch. A related amount of employment land would also be required.

- 6.6.4 The Government Office for the West Midlands subsequently commissioned a study to identify further options for growth that could deliver higher housing numbers. This study has been recently published. It does not proposed higher housing growth for Redditch, but does suggest additional housing growth for Bromsgrove, some of which could be accommodated in proximity to Redditch.
- 6.6.5 Redditch Borough Council, Bromsgrove District Council and Stratford-on-Avon District Council have jointly commissioned two studies associated with the RSS. The first assessed the implications for Redditch of achieving the growth scenarios put forward in the RSS Phase 2 Revision. The second study examined how the proposed growth could best be distributed in Redditch, Bromsgrove and Stratford.

Local Planning Context

- 6.6.6 The Borough of Redditch Local Plan No 3 was adopted in May 2006 and forms part of the Development Plan for the Area. The Council is progressing its Core Strategy, which once adopted will, in part, replace Local Plan No 3. The consultation period on the Preferred Draft Core Strategy was from 31st October 2008 to 8th May 2009. The Borough Council is gathering evidence for the Core Strategy and has a DRAFT Employment Land Review (October 2008) and Sustainability Appraisal Scoping Report (October 2008).
- 6.6.7 The development site is in the administrative boundary of Stratford-upon-Avon District Council. Stratford-upon-Avon's District Local Plan Review was adopted in July 2006 and forms part of the Development Plan for the Area. Stratford is also preparing its Core Strategy and has made the following provision in Policy CS.6(a) – 'approximately 11.7 hectares of land at Winyates Green Triangle will be released for employment development to meet the needs of Redditch'.
- 6.6.8 Redditch Borough Council is currently preparing a Policy for the Diversification Park on this land and Stratford will be requested to incorporate the policy into their Core Strategy document in due course.

6.6.9 The following 'saved' policies (and excerpts from the policies) from the Redditch Local Plan No 3 are relevant to this development proposal:

- C(T).7 Public Transport Infrastructure – 'The Borough Council will support the appropriate expansion and enhancement of the network of Public Transport Routes in the Borough'...
- C(T).12 Parking Standards – 'New development will be expected to comply with the parking standards set out in Appendix H of this Plan [Local Plan No 3]. The Appendix sets out the maximum standards that the Council considers appropriate for any new development. The standards specifically for disabled parking bays and cycle parking are minimum standards and if the development warrants, may be increased. If the development requires parking facilities and these cannot be provided on site, the developer may be asked to contribute to transport related projects in the area'.

6.6.10 For example, for B1 business use class (over 2,500 sqm GFA) would require a maximum of

- 1 car space per 30 sqm GFA
- 1 disabled parking space per 20 car parking spaces
- 1 cycle parking space per 10 car parking spaces
- 1 motorcycle parking space per 20 car parking spaces
- 1 lorry parking space per 2,500 sqm GFA.

6.6.11 The following 'saved' policies (and excerpts from the policies) from the Stratford-upon-Avon's District Local Plan Review are relevant to this development proposal:

- Dev.4 Access – 'New or improved access arrangements to serve development will be treated as an integral part of the overall layout'...
- Dev.5 – Car Parking 'The provision of car parking associated with development proposals will be expected to comply with maximum parking standards of the District Council'...
- Dev.9 Access for People with Disabilities – 'Development to which members of the public would reasonably expect to have access will only be permitted if

provision is made in the design for safe and convenient access by people with disabilities’...

- Com.7 Bus Service Support – ‘The District Planning Authority will work with bus operators, developers, the County Council and other interested parties to protect, improve and extend both conventional and non-conventional bus services to assist local people to gain access to work, shopping, health, leisure and other facilities’...
- Com.9 Walking and Cycling – ‘The layout and design of development proposals will be expected to incorporate facilities for walking and cycling which are safe, convenient to use and well connected to other parts of the settlement’...
- Imp.5 Infrastructure Provision Transport – ‘The District Planning Authority will assess each planning application to gauge the level and form of contribution towards transport-related facilities required as a result of the development’...
- Imp.6 Transport Assessments – ‘Development proposals which generate significant traffic movements will be expected to be accompanied by a Transport Assessment’...
- Imp.7 Green Transport Plans – ‘A Green Transport Plan will be required to be submitted as part of a planning application, or produced through the terms of a Section 106 Agreement, where a development proposal would...cause significant traffic impacts...generate a significant amount of car travel...be situated in an area where public transport facilities are limited’...

6.7 Highway Impact

6.7.1 In order to assess the impact of the proposed development on the local highway network, a range of opening year capacity assessments have been undertaken for 2012. Assessment of a 2017 future year has also been undertaken.

6.7.2 In order to derive the forecast base peak hour traffic flows for the assessment years confirmed above, the existing traffic movements as recorded in the traffic survey have been factored using 1997 NRTF central growth estimates adjusted by TEMPRO to tailor the forecast to local circumstances. The appropriate NRTF adjusted growth factors based on Redditch area are identified in **Tables 16** and **17** below:

| | AM PEAK | PM PEAK |
|-----------------------------|---------|---------|
| 2009 – 2012 Opening Year | 1.040 | 1.047 |
| 2009 – 2017 Design Year | 1.122 | 1.132 |

Table 16 - Adjusted NRTF Growth Factors for Assessment Years – Far Moor Lane, Claybrook Drive and Alders Drive

| | AM PEAK | PM PEAK |
|-----------------------------|---------|---------|
| 2009 – 2012 Opening Year | 1.014 | 1.021 |
| 2009 – 2017 Design Year | 1.055 | 1.064 |

Table 17 - Adjusted NRTF Growth Factors for Assessment Years – A4023 Coventry Highway, A4189 Warwick Highway and A435 Birmingham Road

6.7.3 The resulting 2012 and 2017 peak hour base (without development) traffic flows for the local road network are illustrated on the summary distribution diagrams on drawing numbers **JN835-NWK-009** and **JN835-NWK-010** in **Appendix G**.

6.8 Operational Assessment – Far Moor Lane / Alders Drive

6.8.1 Capacity testing of existing junctions considered to be within the influence of the development site has been confined to the junction of Far Moor Lane with Alders Drive. It was not thought necessary to undertake capacity assessments on any other junctions as they were observed (during the traffic survey work) to be operating well within capacity with little evidence of significant levels of congestion/queuing during the peak hours.

6.8.2 PICADY capacity tests for this junction (using the 20,000 sq.m. Business Innovation Centre trip generations) have been carried out for varying base and future years, as detailed below:

- 2009 Base Traffic Flows

- 2017 Without Development
- 2017 With Development

6.8.3 The full printed output information is contained in **Appendix H** at the rear of the report. The key results from the capacity tests are summarised in **Tables 18 to 20** below.

| AM PEAK | | | PM PEAK | | |
|-------------------------------------|-------------------|------------------------------|------------------------------------|-------------------|------------------------------|
| Junction Arm | Maximum RFC Value | Maximum Queue (no. vehicles) | Junction Arm | Maximum RFC Value | Maximum Queue (no. vehicles) |
| Alders Lane North | 0.109 | 0.12 | Alders Lane North | 0.086 | 0.09 |
| Far Moor Lane | 0.429 | 0.74 | Far Moor Lane | 0.249 | 0.33 |
| Alders Lane South | 0.214 | 0.27 | Alders Lane South | 0.534 | 1.12 |
| Total Vehicle Demand / Hour – 672.6 | | | Total Vehicle Demand / Hour – 1080 | | |
| Total Queuing Delay – 76.6 | | | Total Queuing Delay – 98.5 | | |

**Table 18 - 2009 Base Traffic Flows
Far Moor Lane / Alders Drive Junction**

6.8.4 The summary results of the PICADY outputs clearly illustrate that the Far Moor Lane / Alders Drive junction is currently operating within capacity in both peaks, with minimal queuing occurring e.g. maximum queue length of 1 vehicle on Alders Lane south in the PM peak. This means that the junction is well within capacity and therefore any congestion and queues formed are dispersed within a couple of minutes.

6.8.5 Site observations concluded that the junction is currently impeded by traffic queuing southbound on Alders Drive on the approach to the Warwick Highway roundabout. Traffic queuing southbound for the roundabout are blocking northbound traffic wishing to turn right into Far Moor Lane. This could be mediated by the introduction of a yellow box junction through the use of a Traffic Regulation Order (TRO).

6.8.6 Please note, PICADY does not have the ability to reflect the exact current situation with the queuing traffic from the nearby roundabout or the introduction of the yellow box junction, as it cannot model these parameters. However, it can safely be assumed that the introduction of a yellow box junction would provide results as on **Tables 19 – 20**.

| AM PEAK | | | PM PEAK | | |
|-------------------------------------|-------------------|------------------------------|--------------------------------------|-------------------|------------------------------|
| Junction Arm | Maximum RFC Value | Maximum Queue (no. vehicles) | Junction Arm | Maximum RFC Value | Maximum Queue (no. vehicles) |
| Alders Lane North | 0.133 | 0.15 | Alders Lane North | 0.111 | 0.12 |
| Far Moor Lane | 0.483 | 0.92 | Far Moor Lane | 0.292 | 0.41 |
| Alders Lane South | 0.242 | 0.32 | Alders Lane South | 0.620 | 1.59 |
| Total Vehicle Demand / Hour – 754.3 | | | Total Vehicle Demand / Hour – 1223.2 | | |
| Total Queuing Delay – 91.8 | | | Total Queuing Delay – 128.3 | | |

**Table 19 - 2017 'Without Development' Traffic Flows
Far Moor Lane / Alders Drive Junction**

6.8.7 The summary results of the PICADY outputs clearly illustrate that the Far Moor Lane / Alders Drive junction will operate within capacity in both peaks in 2017, with minimal queuing occurring e.g. maximum queue length of 2 vehicles on Alders Lane south in the PM peak. This means that the junction is well within capacity and therefore any congestion and queues formed are dispersed within a couple of minutes.

| AM PEAK | | | PM PEAK | | |
|-------------------|-------------------|------------------------------|-------------------|-------------------|------------------------------|
| Junction Arm | Maximum RFC Value | Maximum Queue (no. vehicles) | Junction Arm | Maximum RFC Value | Maximum Queue (no. vehicles) |
| Alders Lane North | 0.180 | 0.22 | Alders Lane North | 0.282 | 0.38 |
| Far Moor | 0.532 | 1.12 | Far Moor | 0.618 | 1.57 |

| | | | | | |
|-------------------------------------|-------|------|--------------------------------------|-------|------|
| Lane | | | Lane | | |
| Alders Lane South | 0.663 | 1.90 | Alders Lane South | 0.678 | 2.02 |
| Total Vehicle Demand / Hour – 960.7 | | | Total Vehicle Demand / Hour – 1392.9 | | |
| Total Queuing Delay – 194.5 | | | Total Queuing Delay – 222.6 | | |

**Table 20 - 2017 'With Development' Traffic Flows
Far Moor Lane / Alders Drive Junction**

6.8.8 The summary results of the PICADY outputs clearly illustrate that the Far Moor Lane / Alders Drive junction will operate within capacity in both peaks in 2017 with a 20,000 sq.m Business Innovation Centre development. There would be minimal queuing e.g. a maximum queue length of 2 vehicles on Alders Lane south in the PM peak. This means that the junction is well within capacity and therefore any congestion and queues formed are dispersed within a couple of minutes.

6.9 Operational Assessment – Far Moor Lane / Development access.

6.9.1 ARCADY and PICADY capacity tests (using the 20,000 sqm Business Innovation Centre trip generations) for two alternative site access junction layouts i.e. a roundabout and a staggered crossroads, have been carried out for the future year scenario as detailed below:

- 2017 With Development

6.9.2 The full printed output information is contained in **Appendix H** at the rear of the report. The key results from the capacity tests are summarised in **Tables 21 to 22** below.

| Junction Arm | AM PEAK | | Junction Arm | PM PEAK | |
|----------------------------------|-------------------|------------------------------|----------------------------------|-------------------|------------------------------|
| | Maximum RFC Value | Maximum Queue (no. vehicles) | | Maximum RFC Value | Maximum Queue (no. vehicles) |
| Development Site – Far Moor Lane | 0.037 | 0.04 | Development Site – Far Moor Lane | 0.348 | 0.53 |

| | | | | | |
|--|-------|------|--|-------|------|
| South | | | South | | |
| Development Site – Far Moor Lane North / Illshaw Close | 0.061 | 0.06 | Development Site – Far Moor Lane North / Illshaw Close | 0.433 | 0.75 |
| Illshaw Close – Far Moor Lane North | 0.040 | 0.04 | Illshaw Close – Far Moor Lane North | 0.018 | 0.02 |
| Illshaw Close – Development Site / Far Moor Lane South | 0.057 | 0.06 | Illshaw Close – Development Site / Far Moor Lane South | 0.025 | 0.03 |
| Far Moor Lane South – Development Site | 0.318 | 0.46 | Far Moor Lane South – Development Site | 0.038 | 0.04 |
| Far Moor Lane North – Illshaw Close | 0.012 | 0.01 | Far Moor Lane North – Illshaw Close | 0.026 | 0.03 |
| Total Vehicle Demand / Hour – 720.3 | | | Total Vehicle Demand / Hour – 698.3 | | |
| Total Queuing Delay – 47.1 | | | Total Queuing Delay – 90.0 | | |

**Table 21 - 2017 'With Development' Traffic Flows
Staggered / Right Turn Lane Site Access**

6.9.3 The summary results of the PICADY outputs clearly illustrate that the staggered / right turn lane junction would operate well within capacity in both peaks in 2017 with a 20,000 sqm Business Innovation Centre development. This means that congestion and queues formed at the junction are dispersed within a couple of minutes.

| AM PEAK | | | PM PEAK | | |
|--------------|-------------------|------------------------------|--------------|-------------------|------------------------------|
| Junction Arm | Maximum RFC Value | Maximum Queue (no. vehicles) | Junction Arm | Maximum RFC Value | Maximum Queue (no. vehicles) |
| | | | | | |

| | | | | | |
|-------------------------------------|-------|-----|-------------------------------------|-------|-----|
| Far Moor Lane North | 0.309 | 0.4 | Far Moor Lane North | 0.242 | 0.3 |
| Development Site | 0.037 | 0 | Development Site | 0.315 | 0.5 |
| Far Moor Lane South | 0.359 | 0.6 | Far Moor Lane South | 0.154 | 0.2 |
| Illshaw Close | 0.069 | 0.1 | Illshaw Close | 0.027 | 0 |
| Total Vehicle Demand / Hour – 717.6 | | | Total Vehicle Demand / Hour – 695.7 | | |
| Total Queuing Delay – 77.2 | | | Total Queuing Delay – 69.1 | | |

**Table 22 - 2017 'With Development' Traffic Flows
Roundabout Site Access**

6.9.4 The summary results of the ARCADY outputs clearly illustrate that roundabout junction would operate within capacity in both peaks in 2017 with a 20,000 sqm Business Innovation Centre development. This means that any congestion and queues formed are dispersed within a couple of minutes.

6.10 Preferred Development Site Access Option – Far Moor Lane

6.10.1 The preferred development site access option is for a new roundabout junction on Far Moor Lane, which combines the development site traffic with Far Moor Lane and Illshaw Close flows (drawing number **JN835-NWK-011** in **Appendix H** refers). This site access arrangement is preferred, as it provides ample capacity for the development site in 2017, is relatively cheap to construct, addresses the speeding problem on Far Moor Lane by introducing a speed reduction feature that would alter the inactive frontage on this side of the road and serves to increase pedestrian, cyclist and road user safety.

6.11 Alternative Development Site Access Options

6.11.1 Alternative development site access options evaluated as part of this assessment process include:

- a traffic signal junction on the A435 Birmingham Road including pedestrian and cycle facilities as requested by Warwickshire County Council (drawing number **JN835-NWK-012B** in **Appendix H** refers)

- a roundabout junction on the A4023 Coventry Highway
- a traffic signal junction on the A4023 Coventry Highway (drawing number **JN835-NWK-013** in **Appendix H** refers)

6.12 Operational Assessment – A435 Birmingham Road

6.12.1 LinSig capacity tests (using the 20,000 sqm Business Innovation Centre trip generation rates) have been carried out for the future year scenario as detailed below:

- 2017 With Development

6.12.2 The full printed output information is contained in **Appendix H** at the rear of the report. The key results from the capacity tests are summarised in **Table 23** below.

| AM Peak Hour (08:00-09:00) | | | PM Peak Hour (17:00-18:00) | | |
|---|--------------------------|--------------------------|---|--------------------------|--------------------------|
| Link Name | Degree of Saturation (%) | Mean Maximum Queue (PCU) | Link Name | Degree of Saturation (%) | Mean Maximum Queue (PCU) |
| A435 Birmingham Road (North) Ahead. | 84.4 | 29.7 | A435 Birmingham Road (North) Ahead | 103.9 | 74.2 |
| A435 Birmingham Road (North) Right | 97.6 | 12.8 | A435 Birmingham Road (North) Right | 21.7 | 1.0 |
| A435 Birmingham Road (South) Left Ahead | 103.9 | 79.0 | A435 Birmingham Road (South) Left Ahead | 98.2 | 48.9 |
| New Development Road | 21.5 | 1.4 | New Development Road | 87.4 | 13.4 |
| <i>Cycle Time – 120 Seconds</i> | | | <i>Cycle Time – 120 Seconds</i> | | |

| | |
|-----------------------------------|-----------------------------------|
| <i>PRC –15.5%</i> | <i>PRC – 15.4%</i> |
| <i>Total Delay – 59.97 PCU/Hr</i> | <i>Total Delay – 69.04 PCU/Hr</i> |

Table 23 – 2017 ‘With Development’ Traffic Flows

6.12.3 The summary Linsig results above have demonstrated that the proposed ‘T’ junction on Birmingham Road / New Development Road will operate over its capacity in both the AM and PM peaks with PRC values of -15.5% and -15.4% respectively. This means that queuing and delay at the junction, particularly on the A435 Birmingham Road approaches, will be significant during both peaks periods leading to unacceptable levels of congestion.

6.13 Operational Assessment - A4023 Coventry Highway

6.13.1 Capacity testing has been confined to the traffic signal junction arrangement. It was not considered necessary to undertake capacity assessments on the roundabout design as it is extremely unlikely to have a capacity issue in the future year of 2017.

6.13.2 LinSig capacity tests (using the 20,000 sqm Business Innovation Centre trip generations) have been carried out for the future year scenario, as detailed below:

- 2017 With Development

6.13.3 The full printed output information is contained in **Appendix H** at the rear of the report. The key results from the capacity tests are summarised in **Table 24** below.

| AM Peak Hour (08:00-09:00) | | | PM Peak Hour (17:00-18:00) | | |
|----------------------------|--------------------------|---------------------|----------------------------|--------------------------|---------------------|
| Link Name | Degree of Saturation (%) | Maximum Queue (PCU) | Link Name | Degree of Saturation (%) | Maximum Queue (PCU) |
| | | | | | |

| | | | | | |
|--|------|------|---|------|------|
| A4023 Coventry Highway (West) – Ahead, Right | 77.9 | 28.6 | Coventry Highway (West) – Ahead, Right | 66.1 | 22.1 |
| A4023 Coventry Highway (East) – Ahead, Left | 78.3 | 27.4 | Coventry Highway (East) – Ahead, Left | 66.7 | 19.8 |
| New Development Road (South) | 12.5 | 0.9 | New Development Road (South) | 66.7 | 7.4 |
| <i>Cycle Time – 90 seconds</i> | | | <i>Cycle Time – 90 seconds</i> | | |
| <i>PRC 14.9%</i> | | | <i>PRC 34.9%</i> | | |
| <i>Total Delay 20.77PCU/h</i> | | | <i>Total Delay 19.53PCU/h</i> | | |

Table 24 - 2017 'With Development' Traffic Flows

6.13.4 The summary LinSig results demonstrate that the proposed 'T' Junction of A4023 Coventry Highway / New Development Road will perform within capacity in both the AM and PM peaks with PRC values of 14.9% and 34.9%. This means that the junction is well within capacity and therefore congestion and queues formed are dispersed with a couple of cycles.

6.13.5 It should be noted that no information has been received for the new development to the north of the A4023 Coventry Highway, and no additional traffic from this development has been included in this set of LinSig results.

6.14 Development Access Solution – Summary Appraisal Table

6.14.1 **Table 25** below provides an overall comparative summary of the key appraisal parameters as they relate to each of the possible alternative access solutions to the proposed Diversification Park development, as assessed earlier. The Table highlights the principal benefits and disbenefits of each

option which underpin the decision to select the Far Moor Lane roundabout option as the preferred access solution to serve the Diversification Park.

| | Economy | Efficiency | Safety | Environment | Other factors |
|---|--|---|---|---|---|
| Option 1 Preferred Solution Far Moor Lane Roundabout | Relatively cheap to construct. Estimated cost £400,000 | Operates well within capacity in 2017 with development traffic. Has minimal impact on neighbouring junctions. | Will help to address the existing speeding problems on Far Moor Lane. | Will introduce some visual and noise impact to adjacent residents, particularly during construction. Access is required across wildlife corridor. | Potential of local opposition from residents on Far Moor Lane. Does not provide access option to other potential development land parcels in the area. |
| Option 2 Far Moor Lane Staggered Crossroads | Cheapest of all the options to construct. Estimated cost £250,000 | Operates well within capacity in 2017 with development capacity. Similar performance and local impact to r'dbt option. May introduce delays to Ilshaw Close | Improves pedestrian / cyclist safety on Far Moor Lane but may encourage inappropriate overtaking. | Requires less land than r'dbt option but will have similar local amenity impacts as roundabout. Access is again required across wildlife corridor. | Likely to be the most acceptable solution on Far Moor Lane to local residents and local authorities. Minimal impact on strategic roads in the area. Only serves Diversification Park. |
| Option 3 A435 Birmingham Road Traffic Signals | Cheapest access option from A road network. Estimated cost £450-500,000 | Over capacity in 2017 with development traffic. Not so convenient for local access as Far Moor Lane options. | Provides a safe means of access to development for vulnerable road users but may increase risk of shunt collisions. | Least intrusive of all the options in terms of impact on neighbouring residential areas. Minimal third party land required for construction. | Most convenient option for strategic access for vehicles from the east and south of Redditch. Unlikely to gain Warwickshire CC support due to inefficient operation. |
| Option 4 A4023 Coventry Highway Roundabout | Most expensive to construct. Estimated cost £5 million | Will be able to cater for the development traffic and many years of network traffic growth beyond 2017. | Large r'dbt poses significant risk to vulnerable road users and may confuse unfamiliar drivers. | Scale of roundabout will create significant visual and noise impact on adjacent properties. Likely to lead to poorer air quality. Large land take requirements. | Provides access solution to serve potential development land on north side of Coventry highway. May be difficult to construct due to level difference across site. |
| Option 5 A4023 Coventry Highway Traffic Signals | Cheaper than r'dbt but still significant cost to construct. Estimate - £3 million | Ample capacity for predicted 2017 traffic flows but introduces considerable delay to A4023 Redditch traffic. | Safer option to vulnerable road users than r'dbt on Coventry Highway but complex layout may increase risk of collision. | Although less intrusive than r'dbt option and requiring minimal third party land, delays to traffic will increase noise levels locally and air quality will | Offers similar access benefits as Option 4, but will have the greatest impact of all the options in terms of detriment to the efficiency of the highway network. |

Table 25 – Access option summary appraisal table.

7 POTENTIAL MITIGATION MEASURES

7.1 Introduction

7.1.1 This chapter discusses various transport measures and initiatives, which could be introduced to mitigate the vehicular impact of the proposed development.

7.2 Bus Service Improvements

7.2.1 Bus service improvements could be made to increase the frequency of services on Far Moor Lane particularly in the peak hours e.g. improving the hourly service to half hourly into Redditch and connecting to the railway station. At a later stage of the development, bus services could divert into the development site if provided with adequate infrastructure.

7.3 Bus Stop Infrastructure

7.3.1 Bus Stop infrastructure in Redditch is currently to a varying standard dependent on the popularity of the stop. This development proposal is likely to increase bus patronage and will thus necessitate improvements to the nearest bus stops on Far Moor Lane e.g. provision of adequate shelters and easy access kerbing at the bus stop.

7.4 Cycle Parking Provision

7.4.1 The provision of good quality cycle parking is very important to complement car parking policies. The development will provide cycle parking provision in accordance with government guidance and local guidance.

7.5 Cycle Infrastructure

7.5.1 Redditch's urban road infrastructure is conducive to cycling, with its network of residential roads and footpath/underpass connections bypassing busier roads. The area would benefit from pedestrian/cycle signage to encourage the use of these sustainable modes of travel.

7.6 Travel Plan

7.6.1 A Travel Plan is a specific package of measures tailored to suit the needs of individual sites aimed at promoting greener, cleaner travel choices and reducing single occupancy car journeys.

7.6.2 The objectives for the Travel Plan would be to enable modal choice for employees of the site and to reduce single occupancy car trips associated with the site. It will address commuter journeys and business journeys. For example, measures could include an information pack for visitors with bus timetables.

7.6.3 The Travel Plan would include a range of mechanisms, initiatives, targets, indicators and associated monitoring/review procedures to reduce the impact of travel associated with the site on the environment. For example, it would be likely to include targets to encourage the use of local bus services.

7.7 Urban Design

7.7.1 Urban design considers the form and function of the urban areas surrounding individual buildings. Good urban design reconciles form and function, and can improve urban viability. Access, siting and design are inseparable.

7.7.2 Essential requirements for good urban design include:

- Permeability – so people can go where they want
- Legibility – so people can understand their surroundings
- Robustness and Richness – the space should be flexible and interesting

7.7.3 Measures for improving permeability and legibility for pedestrians could include more pedestrian crossings, more direct and convenient routes for walking, and decreased speed limits within the development site e.g. 20 mph zones to reduce car speeds and improve pedestrian and cyclist safety.

7.7.4 Measures for improving permeability and legibility for cyclists could include improving cycle safety, provision of parking for bicycles, and cycle priority at junctions or through purpose built cycleways throughout the development.

7.8 Speed Reduction on Far Moor Lane

7.8.1 It is proposed to provide a new roundabout to access the development off Far Moor Lane. This would be an effective speed reduction measure, as it would alter the inactive frontage on this side of the road. In addition, further traffic calming measures such as speed tables/cushions, and the introduction of a 7.5 tonne weight limit on Far Moor Lane would support these mitigation measures.

8 SUMMARY AND CONCLUSIONS

- 8.1 Morgan Tucker was commissioned by Redditch Borough Council to investigate and advice on the transport and highways issues associated with a proposed diversification park on land sandwiched between the A4023 Coventry Highway and A435 Birmingham Road, and to produce a transport assessment, which meets the requirements of both Worcestershire County Council and Warwickshire County Council.
- 8.2 The proposed development site is situated on land bounded by Far Moor Lane to the west, the A435 Birmingham Road to the east, and the A4023 Coventry Highway to the north.
- 8.3 The personal injury collision statistics for the five year period from January 2004 to August 2009 were obtained from Warwickshire and Worcestershire County Councils. Based on the information identified in the collision analysis, it is considered likely that the development proposals will not result in a statistically significant increase in the frequency or severity of collisions in the area surrounding the development site.
- 8.4 In order to ascertain the speed of traffic travelling along Far Moor Lane, the A4023 Coventry Highway and the A435 Birmingham Road past the proposed development site, a manual speed survey was undertaken on the A4023 Coventry Highway, and ATC data for Far Moor Lane and the A435 Birmingham Road was used to obtain speed survey information for those roads. The speed survey results showed that vehicles are travelling in excess of the 30 mph speed limit along Far Moor Lane and in excess of the 40 mph speed limit along the A435 Birmingham Road.
- 8.5 Analysis of the pedestrian and cycle infrastructure, and bus and rail services in the vicinity of the site confirms that there are realistic opportunities for future users of the development to adopt sustainable modes of travel to access the wider area.
- 8.6 Car and cycle parking spaces will be provided in accordance with government guidance, and specific local guidance.

- 8.7 It is proposed to create a Diversification Park to facilitate businesses in Redditch by manufacturing new products for growth sectors or finding alternative markets for their current products.
- 8.8 The proposed development would generate a worst case of 225 2-way trips in the AM peak hour and 185 2-way trips in the PM peak hour for 10,000 sqm business innovation development, and 450 2-way trips in the AM peak hour and 370 2-way trips in the PM peak hour for 20,000 sqm business innovation development.
- 8.9 Capacity testing has been undertaken on the two different potential site access junction arrangements (staggered / right turn lane and roundabout) on Far Moor Lane and the remote junction of Far Moor Lane with Alders Drive. The results demonstrate that the staggered / right turn lane junction and roundabout access solutions would operate within capacity in both peaks in 2017 with a 20,000 sqm Business Innovation Centre development. The Far Moor Lane / Alders Drive junction would also operate within capacity in both peaks in 2017 with a 20,000 sqm Business Innovation Centre development. There would be minimal queuing e.g. maximum queue length of 2 vehicles on Alders Lane south in the PM peak.
- 8.10 Capacity testing has been undertaken on two different potential site access junction arrangements (traffic signal junction) on the A435 Birmingham Road and the A4023 Coventry Highway. The results demonstrate that a traffic signal junction on the A435 Birmingham Road, designed to the requirements of Warwickshire County Council, would not perform adequately in either the AM or PM peaks in 2017. This means that the junction would become congested leading to long queue lengths and subsequently a long waiting time. Both a traffic signal solution and a roundabout option on the A4023 Coventry Highway would perform within capacity in both the AM and PM peaks. This means that the junction is well within capacity and therefore congestion and queues formed are dispersed with a couple of cycles.
- 8.11 Combining the results of the capacity testing exercise with an appraisal of economic, safety and environmental impacts as they apply to each access option, it has been concluded that a new roundabout junction on Far Moor

Lane will provide the best overall access solution to serve the Diversification Park.

- 8.12 Based on the findings of this assessment, it can be concluded that this proposal is a good example of sustainable development in accordance with the ethos of PPS1, PPG13, West Midlands RSS and local policies contained in both Worcestershire and Warwickshire's Local Plan / Development Frameworks.

APPENDIX A

Scoping Note

Access to Diversification Park at Winyates Green Triangle

Transport Assessment

Scoping Note

Development Proposal

Morgan Tucker have been appointed by Redditch Borough Council, to investigate and advice on the transport and highways issues associated with a proposed diversification park on land sandwiched between the A4023 Coventry Highway and A435 Birmingham Road, and to produce a transport assessment which meets the requirements of both Worcestershire County Council and Warwickshire County Council.

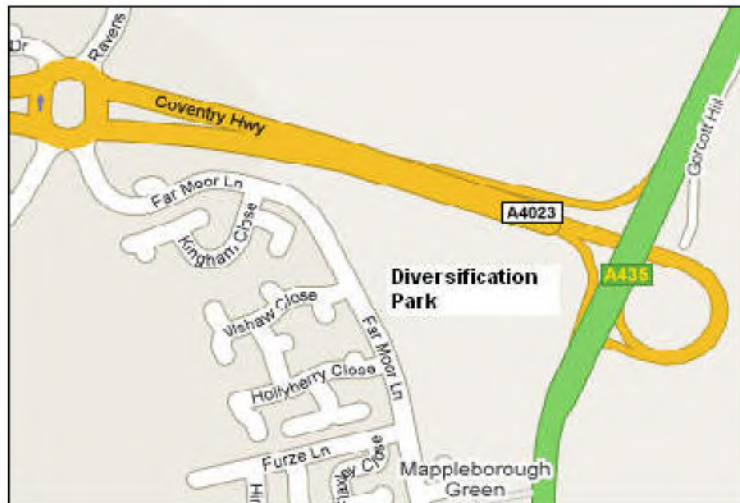

At this preliminary scoping stage, it is envisaged that access to the development site will be provided from the A4023 Coventry Highway, with two further alternative notional access points - one off Far Moor Lane and one off the A435 Birmingham Road.

The transport assessment will identify a preliminary access solution to serve the development, which takes into account local design standards and safety requirements.

Trip Generation

Subject to agreement with Worcestershire County Council and Warwickshire County Council, it is proposed that average multi-modal person trip rates generated from the development will be calculated using suitable TRICS 2009 (a) data for a business park.

Sustainable Transport

The accessibility of the site for modes of transport other than the car will be evaluated as part of the overall assessment and the scope for providing improvements to encourage trips by more sustainable transport options investigated. This section of the appraisal will look at the nature and condition of the local pedestrian infrastructure including the proposed access arrangements to the site for pedestrians and will advise on measures that could be implemented to make walking a more attractive proposition.

Similarly, the condition and availability of cycle facilities in the immediate vicinity of the site will be explored and discussed, with recommendations made as to how the accessibility of the site for cyclists could be improved.

Finally, this section will confirm the extent of the local public transport provision including the frequency and convenience of bus and rail services in the area. A brief commentary will be provided on how to encourage users of the development to use these services.

Road Safety Analysis

The assessment will also investigate the recent personal injury collision data on the road network within the vicinity of the development. The appraisal will examine the most recently available five-year collision statistics provided by Worcestershire County Council and Warwickshire County Council and analyse the detailed statistics for each of the collisions to confirm trends and patterns.

We suggest the catchment area below (red line) is appropriate, but please advice if you require further analysis.

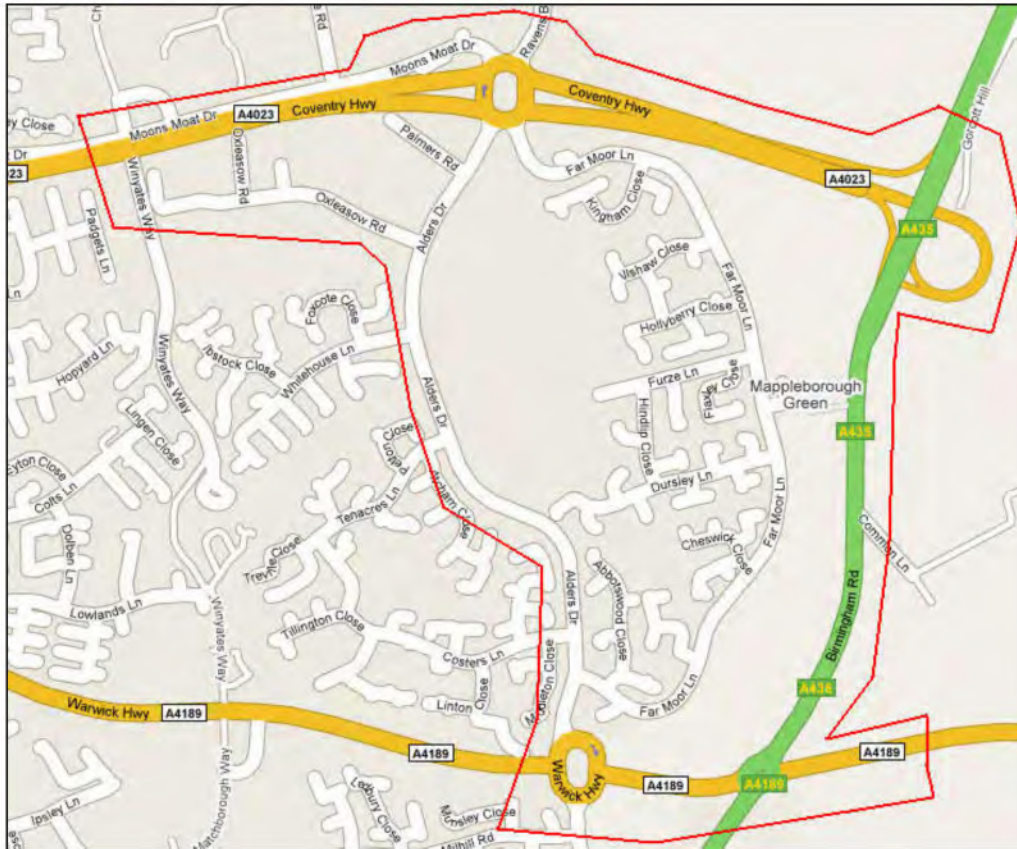

Trip Distribution

An initial appraisal of the distribution and assignment of the generated trips from the new development will be carried out using information from the 2001 national census for Redditch. Analysis of this data will provide a matrix of movements by mode to and from the development for typical peak hours.

Committed Developments

Please advise of any Committed Development that you wish included in our traffic forecasts.

Traffic Surveys

We will obtain suitable traffic flow data to determine the existing 'base' traffic volumes at the junctions of:

- A4023 Coventry Highway / Far More Lane / Alders Drive
- A435 Birmingham Road / A4189 Warwick Highway
- A4189 Warwick Highway / Alders Drive / Claybrook Drive

We would assume that peak hour surveys of 7-10am, 11-2pm and 4-7pm would be sufficient. Please advise that these hours are adequate.

It is our intention to survey the week commencing the 7th September 2009. Please advise if this is not acceptable.

Please advise whether there are any further junctions, which you would want included.

(We have already contacted both Highways Authorities and unfortunately, neither authority can provide traffic data).

Impact Assessment

The operational assessment will consider the highway impact of the traffic generated from the development on sensitive junctions within the vicinity of the site.

We will assess the:

- A4023 Coventry Highway / Far More Lane / Alders Drive
- A435 Birmingham Road / A4189 Warwick Highway
- A4189 Warwick Highway / Alders Drive / Claybrook Drive

Along with the:

- access off the A4023 Coventry Highway;
- two further alternative access points - one off Far Moor Lane and one off the A435 Birmingham Road.

The operational assessment of the junctions will be carried out using standard industry software (PICADY / ARCADY / LinSig etc) as appropriate.

Base and with development traffic scenarios will be examined for a proposed development-opening year of 2011 and 2016 design year, and the capacity tests will be run for both the AM, lunchtime and PM peak hour periods.

Forecast base traffic demand data for the future year tests will be calculated from traffic survey information for the junctions, growthed using TEMPRO adjusted NRTF traffic growth factors for the area.

Travel Plan

Please advise whether a Business Travel Plan will be required.

Report Format

The transport assessment report will follow the guidelines as set out in the CLG / DfT Guidance on Transport Assessment and will also take account of any advice on content and layout as recommended by Worcestershire County Council and Warwickshire County Council.

APPENDIX B

Location Plan



Reproduced by permission of Ordnance Survey on behalf of
 HMSO © Crown Copyright 2006. All rights reserved.
 Ordnance Survey Licence number 100046211



Copyright © Morgan Tucker
 DO NOT SCALE. USE FIGURED DIMENSIONS ONLY.
 CHECK ON SITE AND REPORT ALL DISCREPANCIES TO
 MORGAN TUCKER.

| Rev | Amendment | Date |
|-----|-----------|------|
| | | |



AURA Commerce and Technology Centre, Manners Road, Newark
 Nottinghamshire, NG24 1BS
 Tel:- 01636 610 766 Fax:- 01636 610 786
 E-Mail:- info@morgantucker.co.uk
 www.morgantucker.co.uk

Client
 Redditch Borough Council

Project Title
 Proposed Diversification Park Development

Drawing Title
 Location Plan

Drawn By CR Checked By LB Approved By BS

Date 24/09/09 Scale NTS

Purpose Information

Drawing Number
JN835 - NWK - 001

APPENDIX C

Personal Injury Collision Data

Injury Accident Report for Mappleborough Green area

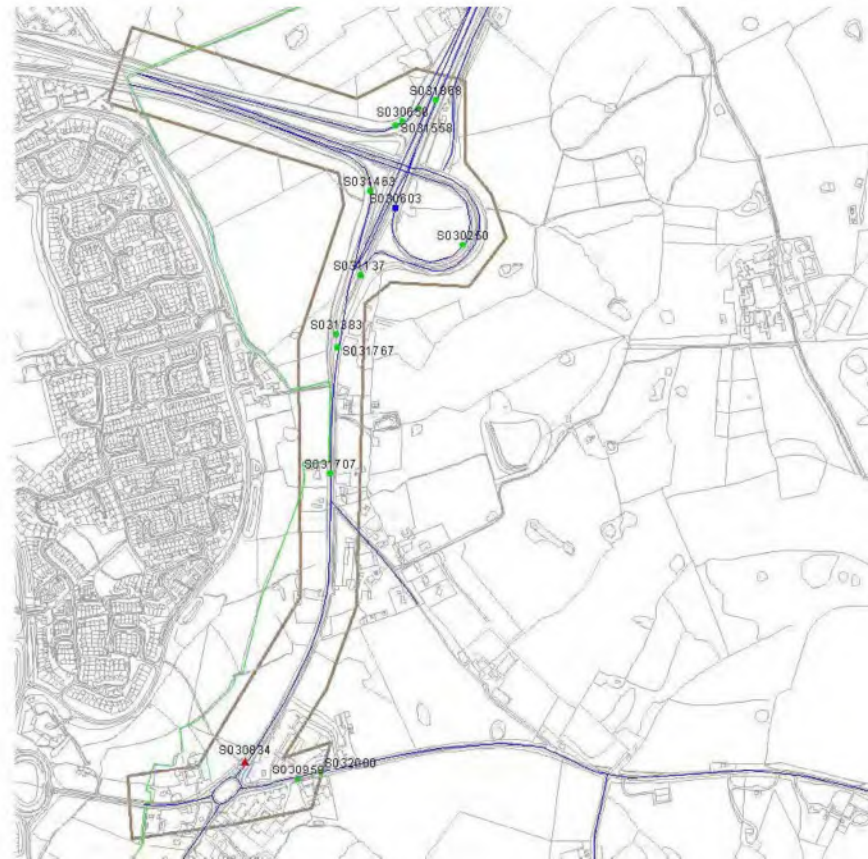

This map is reproduced from the Ordnance Survey material with the permission of Ordnance Survey on behalf of the Controller of Her Majesty's Stationery Office.
© Crown copyright. Unauthorised reproduction infringes Crown copyright and may lead to prosecution or civil proceedings. Warwickshire County Council. 100019520.
2009.

- ▲ Fatal
- Serious
- Slight

Injury accident patterns, where discernable:

| | <u>Site</u> | <u>County</u> 2008 |
|---|-------------|-----------------------|
| Peak day | Wed | Tuesday |
| Peak month | Dec | February |
| Percentage dark (including dark lit) | 35.7% | 29.8% |
| Percentage wet | 42.9% | 36.8% |
| Severity Rate | 14.3% | 17.3% |

| Injury Accidents | | | | |
|------------------|----------|----------|-----------|-----------|
| | Fatal | Serious | Slight | Total |
| 2004 | 0 | 0 | 2 | 2 |
| 2005 | 0 | 0 | 2 | 2 |
| 2006 | 0 | 0 | 4 | 4 |
| 2007 | 0 | 0 | 2 | 2 |
| 2008 | 1 | 1 | 2 | 4 |
| 2009 | 0 | 0 | 0 | 0 |
| Total | 1 | 1 | 12 | 14 |

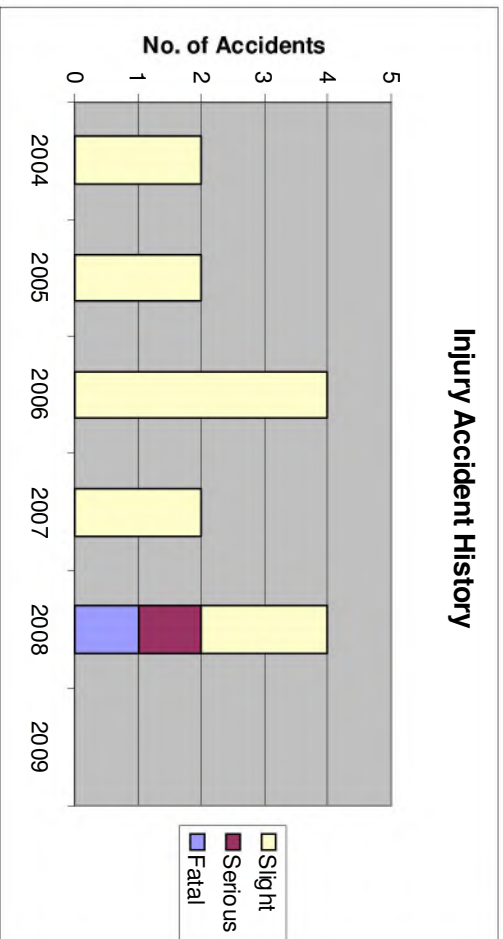

| Casualties | | | | |
|--------------|----------|----------|-----------|-----------|
| | Fatal | Serious | Slight | Total |
| 2004 | 0 | 0 | 2 | 2 |
| 2005 | 0 | 0 | 2 | 2 |
| 2006 | 0 | 0 | 4 | 4 |
| 2007 | 0 | 0 | 3 | 3 |
| 2008 | 1 | 1 | 3 | 5 |
| 2009 | 0 | 0 | 0 | 0 |
| Total | 1 | 1 | 14 | 16 |

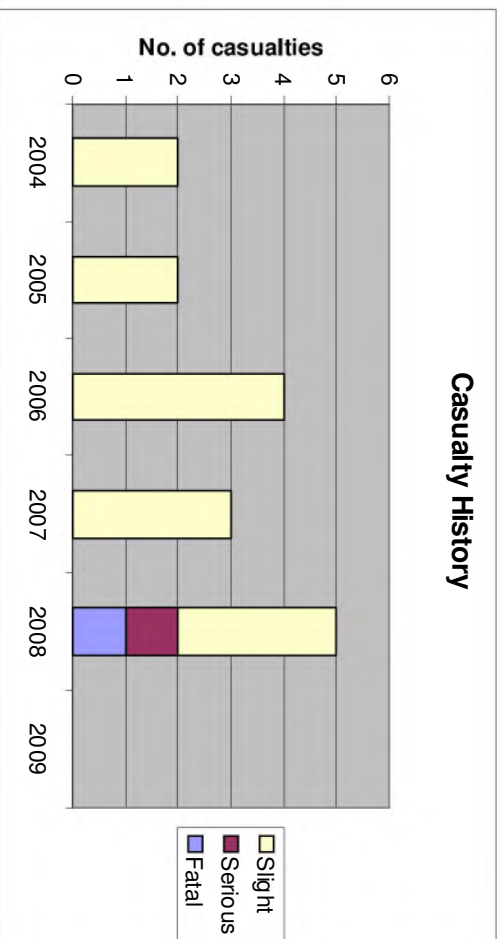

Injury Accidents by Day of Week

| | Fatal | Serious | Slight | Total |
|------------------|-------|---------|--------|-------|
| Sunday | 0 | 0 | 1 | 1 |
| Monday | 0 | 0 | 2 | 2 |
| Tuesday | 0 | 0 | 2 | 2 |
| Wednesday | 0 | 0 | 4 | 4 |
| Thursday | 0 | 1 | 0 | 1 |
| Friday | 0 | 0 | 2 | 2 |
| Saturday | 1 | 0 | 1 | 2 |
| Total | 1 | 1 | 12 | 14 |

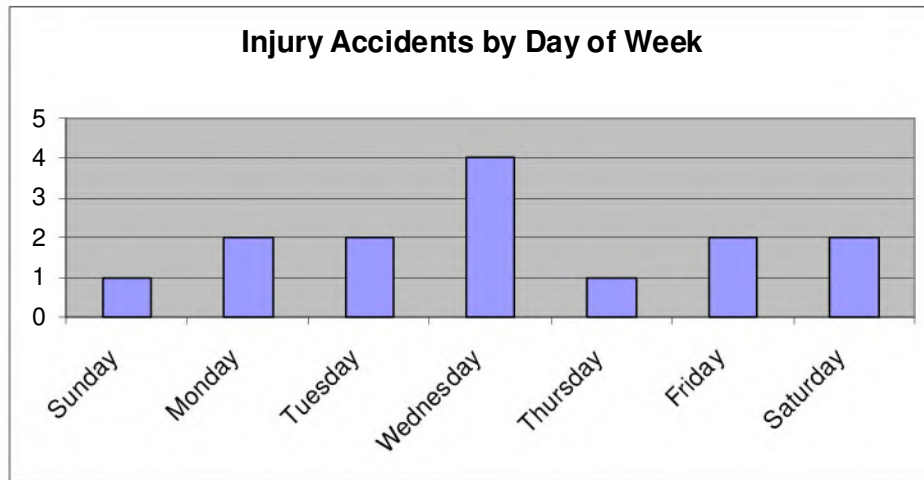

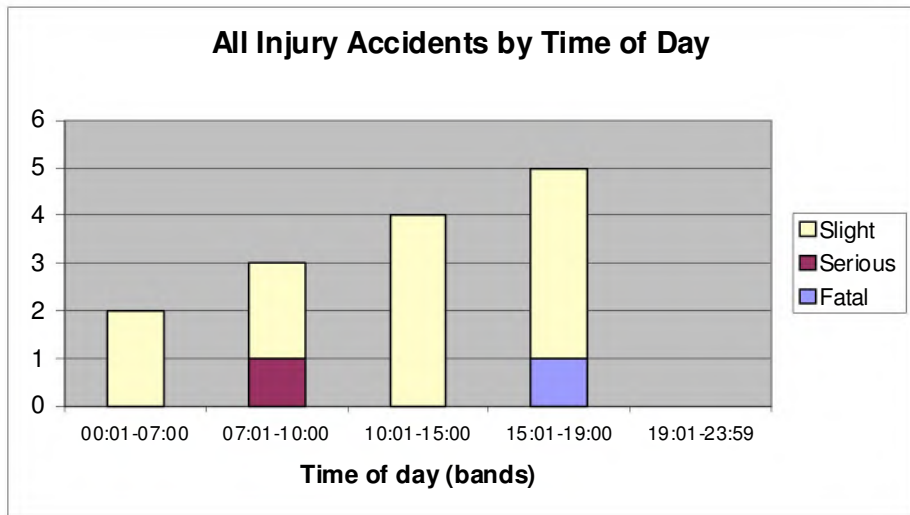
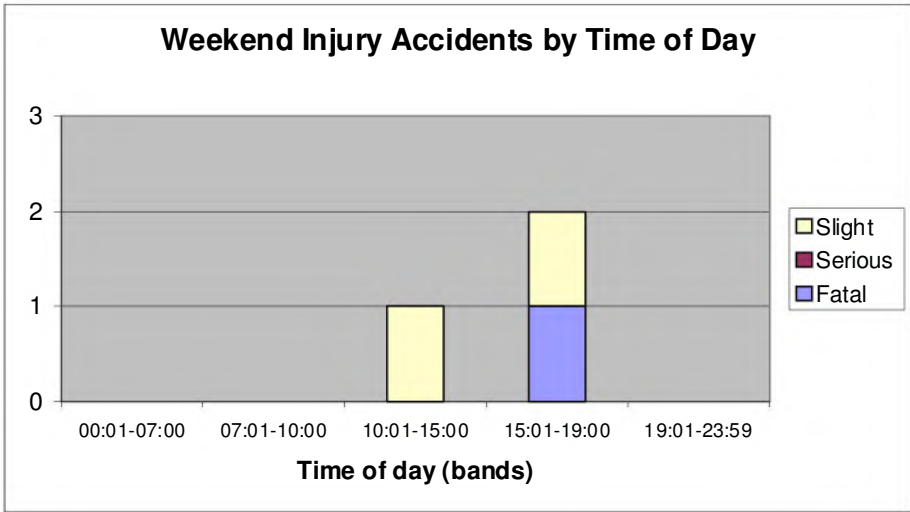
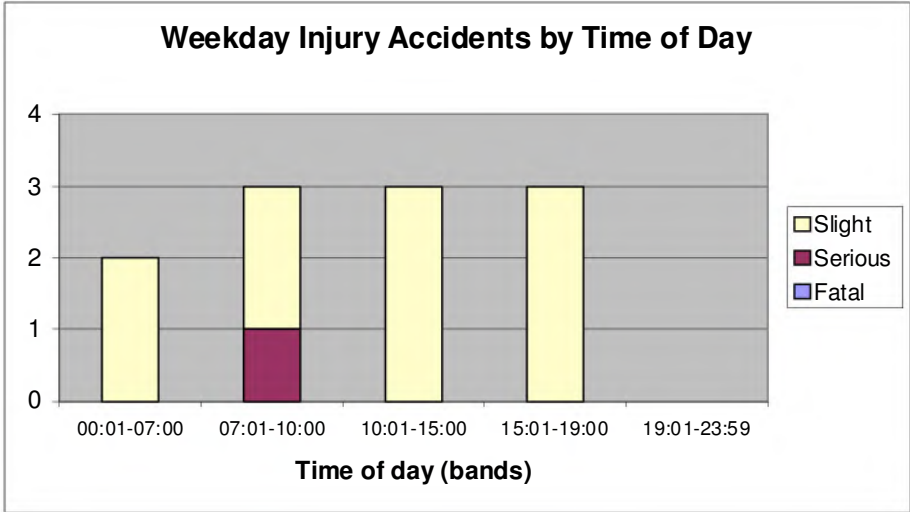

Injury Accidents by Month

| | Fatal | Serious | Slight | Total |
|--------------|----------|----------|-----------|-----------|
| January | 0 | 0 | 0 | 0 |
| February | 0 | 0 | 1 | 1 |
| March | 0 | 0 | 0 | 0 |
| April | 0 | 1 | 0 | 1 |
| May | 0 | 0 | 1 | 1 |
| June | 1 | 0 | 1 | 2 |
| July | 0 | 0 | 0 | 0 |
| August | 0 | 0 | 1 | 1 |
| September | 0 | 0 | 0 | 0 |
| October | 0 | 0 | 2 | 2 |
| November | 0 | 0 | 2 | 2 |
| December | 0 | 0 | 4 | 4 |
| Total | 1 | 1 | 12 | 14 |

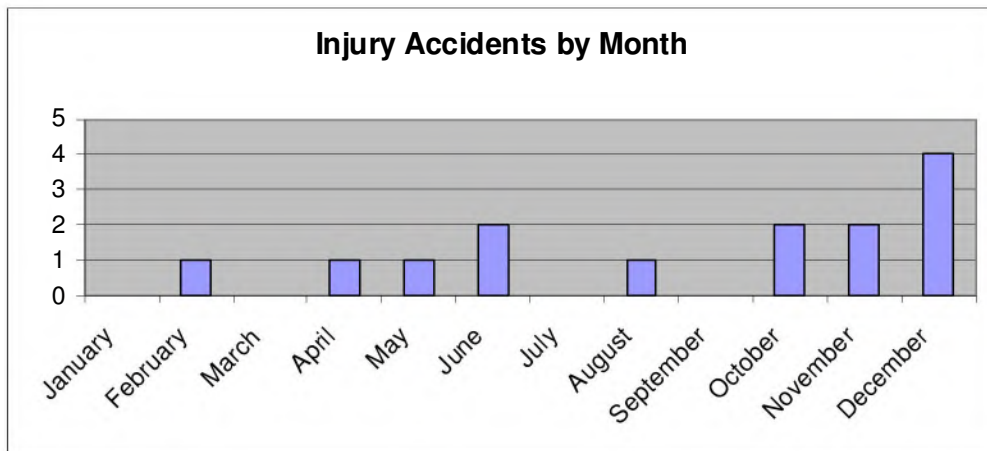

Injury Accidents by Road Surface Condition

| | Fatal | Serious | Slight | Total | %age |
|--------------|----------|----------|-----------|-----------|-------|
| Dry | 1 | 0 | 7 | 8 | 57.1% |
| Wet | 0 | 1 | 5 | 6 | 42.9% |
| Total | 1 | 1 | 12 | 14 | |

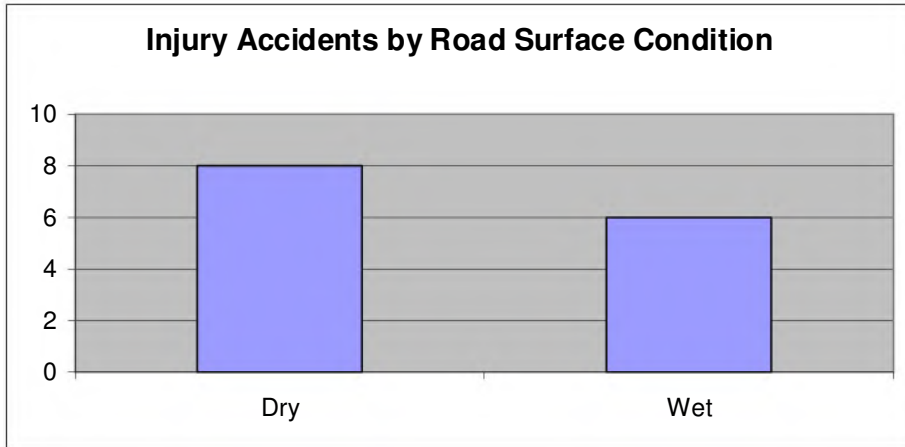

Injury Accidents by Light Condition

| | Fatal | Serious | Slight | Total | %age |
|---------------------|----------|----------|-----------|-----------|-------------|
| Daylight | 1 | 1 | 7 | 9 | 64.3% |
| Dark lit | 0 | 0 | 4 | 4 | |
| Dark unlit | 0 | 0 | 1 | 1 | Dark |
| Dark unknown | 0 | 0 | 0 | 0 | 35.7% |
| Total | 1 | 1 | 12 | 14 | |

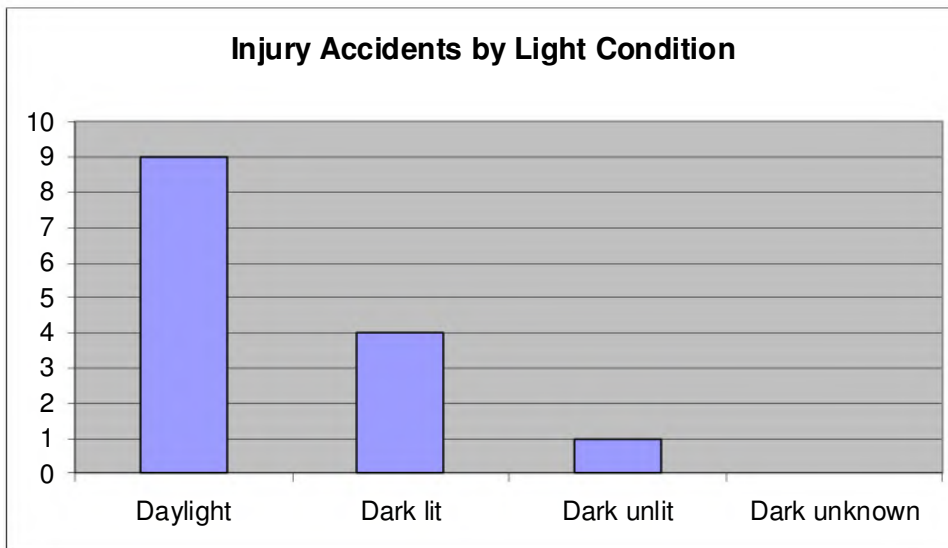

| <u>Ref No</u> | <u>Date</u> | <u>Road</u> | <u>Accident</u> | <u>Severity</u> | <u>Day of Week</u> | | | |
|--|-----------------|---------------------|-----------------|------------------|--------------------|-------------------------|--|---|
| S031868 | 26/11/04 | A0435 | Slight | | Friday | | | |
| - A435 Alcester Rd s/b, Studley, approx 100m NE exit slip for A4023 | | | | | | | | |
| - Coventry Highway | | | | | | | | |
| V1 trav SW on A435 s/b swerved to o/s to avoid vehicle reversing from exit slip & hit central barrier. | | | | | | | | |
| <u>East</u> | <u>North</u> | <u>Weather</u> | <u>Surface</u> | <u>Light</u> | <u>Time</u> | <u>No of Casualties</u> | | 1 |
| 408809 | 268049 | Fine | Dry | Light | 1420 | <u>No. of Vehicles</u> | | 1 |
| <u>Vehicle No</u> | <u>and Type</u> | <u>Driver/Rider</u> | <u>Age</u> | <u>Direction</u> | <u>Breath Test</u> | | | |
| 1 | Car | Male | 21 | NE to SW | Not reqd | | | |
| Casualty | 1 Slight | Driver | Male | Age | 21 | | | |

| <u>Ref No</u> | <u>Date</u> | <u>Road</u> | <u>Accident</u> | <u>Severity</u> | <u>Day of Week</u> | | | |
|---|------------------------|---------------------|-----------------|------------------|--------------------|-------------------------|--|---|
| S032000 | 17/12/04 | A4189 | Slight | | Friday | | | |
| - A4189 Warwick Road Mappleborough Green, 150yards east of junc with A435 | | | | | | | | |
| - (Dog Island) | | | | | | | | |
| V2 (Agricultural tractor and trailer) stationary on n/s of road having broken down. V1 collides with rear of V2 | | | | | | | | |
| <u>East</u> | <u>North</u> | <u>Weather</u> | <u>Surface</u> | <u>Light</u> | <u>Time</u> | <u>No of Casualties</u> | | 1 |
| 408588 | 266759 | Rain | Wet | Dark lit | 1840 | <u>No. of Vehicles</u> | | 2 |
| <u>Vehicle No</u> | <u>and Type</u> | <u>Driver/Rider</u> | <u>Age</u> | <u>Direction</u> | <u>Breath Test</u> | | | |
| 1 | Car | Male | 46 | W to E | - ve | | | |
| Casualty | 1 Slight | Driver | Male | Age | 46 | | | |
| 2 | Other | Male | 28 | Parked | - ve | | | |
| | <u>WCC factor code</u> | ---- | | Parked vehicle | | | | |

| <u>Ref No</u> | <u>Date</u> | <u>Road</u> | <u>Accident</u> | <u>Severity</u> | <u>Day of Week</u> | | | |
|---|---------------------|---------------------|-----------------|------------------|--|-------------------------|--|---|
| S031383 | 03/10/05 | A0435 | Slight | | Monday | | | |
| - A435 Alcester Rd, Mappleborough Green, os Woodside Cherry Tree Farm | | | | | | | | |
| - V1 & V2 trav N, V3 trav S on A435. V1 attempted U-turn | | | | | | | | |
| V2 hit V1, then V3 hit V1. | | | | | | | | |
| <u>East</u> | <u>North</u> | <u>Weather</u> | <u>Surface</u> | <u>Light</u> | <u>Time</u> | <u>No of Casualties</u> | | 1 |
| 408618 | 267600 | Fine | Dry | Dark lit | 1800 | <u>No. of Vehicles</u> | | 3 |
| <u>Vehicle No</u> | <u>and Type</u> | <u>Driver/Rider</u> | <u>Age</u> | <u>Direction</u> | <u>Breath Test</u> | | | |
| 1 | Car | Male | 31 | S to S | - ve | | | |
| 2 | Car | Male | 59 | S to N | - ve | | | |
| Casualty | 1 Slight | Driver | Male | Age | 59 | | | |
| 3 | Car | Female | 33 | N to S | Not reqd | | | |
| | <u>Factor codes</u> | 403 | V001 | A | Poor turn or manoeuvre | | | |
| | | 406 | V001 | A | Failed to judge other person's path or speed | | | |

| <u>Ref No</u> | <u>Date</u> | <u>Road</u> | <u>Accident</u> | <u>Severity</u> | <u>Day of Week</u> | | | |
|---|---------------------|---------------------|-----------------|------------------|---------------------------------|-------------------------|------|---|
| S031767 | 14/12/05 | A0435 | Slight | | Wednesday | | | |
| - A435 Birmingham Rd Mappleborough Green o/s Woodside Cherry Farm | | | | | | | | |
| - V2 braked suddenly to avoid a dog , V1 collided into rear of V2 | | | | | | | | |
| <u>East</u> | <u>North</u> | <u>Weather</u> | <u>Surface</u> | <u>Light</u> | <u>Time</u> | <u>No of Casualties</u> | | 1 |
| 408619 | 267574 | Fine | Wet | Light | 1135 | <u>No. of Vehicles</u> | | 2 |
| <u>Vehicle No</u> | <u>and Type</u> | <u>Driver/Rider</u> | <u>Age</u> | <u>Direction</u> | <u>Breath Test</u> | | | |
| 1 | Car | Female | 53 | S to N | - ve | | Skid | |
| 2 | Car | Male | 38 | S to N | - ve | | | |
| Casualty | 1 Slight | Driver | Male | Age | 38 | | | |
| | <u>Factor codes</u> | 109 | V002 | A | Animal or object in carriageway | | | |
| | | 308 | V001 | A | Following too close | | | |
| | | 408 | V002 | A | Sudden braking | | | |

| <u>Ref No</u> | <u>Date</u> | <u>Road</u> | <u>Accident</u> | <u>Severity</u> | <u>Day of Week</u> | | | |
|---|-------------|-------------|-----------------|-----------------|--------------------|--|--|--|
| S030658 | 15/05/06 | A0435 | Slight | | Monday | | | |
| - A435 Slip rd Gorcott Hill nb gr 408738/268023 | | | | | | | | |
| - V1 overtakes slower moving veh on slip road attempts to return to nearside lane loses control slides onto nearside verge slides down embankment | | | | | | | | |

| <u>East</u> | <u>North</u> | <u>Weather</u> | <u>Surface</u> | <u>Light</u> | <u>Time</u> | <u>No of Casualties</u> | | |
|-------------------|---------------------|---------------------|---|------------------|--------------------|-------------------------|---|--|
| 408745 | 268009 | Rain | Wet | Light | 0840 | | 1 | |
| <u>Vehicle No</u> | <u>and Type</u> | <u>Driver/Rider</u> | <u>Age</u> | <u>Direction</u> | <u>Breath Test</u> | <u>No. of Vehicles</u> | | |
| 1 Car | | Male | 56 | W to N | - ve | | 1 | |
| Casualty | 1 Slight | Driver | Male | Age | 56 | | | |
| | <u>Factor codes</u> | 103 V001 A | Slippery road (due to weather) | | | | | |
| | | 108 V001 B | Road layout (e.g. bend, hill, narrow carriageway) | | | | | |
| | | 307 V001 A | Travelling too fast for conditions | | | | | |
| | | 410 V001 A | Loss of control | | | | | |

| <u>Ref No</u> | <u>Date</u> | <u>Road</u> | <u>Accident Severity</u> | <u>Day of Week</u> | | | | |
|--|---------------------|---------------------|---------------------------------|--------------------|--------------------|-------------------------|---|--|
| S031137 | 22/08/06 | A0435 | Slight | Tuesday | | | | |
| - A435 JW A4023 Mappleborough Green | | | | | | | | |
| - V2 travel south on A435 when V1 pulls from A4023 slip road into path of V2 causing V2 to loose control and leave carriageway nearside. V1 drives off | | | | | | | | |
| <u>East</u> | <u>North</u> | <u>Weather</u> | <u>Surface</u> | <u>Light</u> | <u>Time</u> | <u>No of Casualties</u> | | |
| 408663 | 267714 | Fine | Dry | Light | 0800 | | 2 | |
| <u>Vehicle No</u> | <u>and Type</u> | <u>Driver/Rider</u> | <u>Age</u> | <u>Direction</u> | <u>Breath Test</u> | <u>No. of Vehicles</u> | | |
| 1 Car | | Unknown | | E to S | No contact | | | |
| 2 Car | | Female | 18 | N to S | Not reqd | | 1 | |
| Casualty | 1 Slight | Driver | Female | Age | 18 | | | |
| | <u>Factor codes</u> | 302 V001 A | Disobeyed give way or stop sign | | | | | |
| | | 401 V001 A | Junction overshoot | | | | | |
| | | 601 V001 A | Aggressive driving | | | | | |
| | | 501 V001 B | Impaired by alcohol | | | | | |

| <u>Ref No</u> | <u>Date</u> | <u>Road</u> | <u>Accident Severity</u> | <u>Day of Week</u> | | | | |
|--|---------------------|---------------------|---------------------------------|--------------------|--------------------|-------------------------|---|--|
| S031463 | 04/10/06 | A0435 | Slight | Wednesday | | | | |
| - A435 100m south of jw A4023 Mappleborough Green | | | | | | | | |
| - V4 trav N stops in queue of traffic with V3 behind. V1 runs into rear of V3 pushing it into rear of V4. V2 runs into rear of V1. | | | | | | | | |
| <u>East</u> | <u>North</u> | <u>Weather</u> | <u>Surface</u> | <u>Light</u> | <u>Time</u> | <u>No of Casualties</u> | | |
| 408682 | 267876 | Fine | Dry | Light | 0755 | | 4 | |
| <u>Vehicle No</u> | <u>and Type</u> | <u>Driver/Rider</u> | <u>Age</u> | <u>Direction</u> | <u>Breath Test</u> | <u>No. of Vehicles</u> | | |
| 1 Car | | Female | 52 | S to NW | - ve | | | |
| Casualty | 1 Slight | Driver | Female | Age | 52 | | | |
| 2 Car | | Female | 26 | S to NW | - ve | | | |
| 3 Car | | Male | 26 | S to NW | - ve | | | |
| 4 Car | | Male | 39 | S to NW | - ve | | | |
| | <u>Factor codes</u> | 308 V001 A | Following too close | | | | | |
| | | 308 V002 A | Following too close | | | | | |
| | | 706 V001 B | Vision affected by dazzling sun | | | | | |
| | | 706 V002 B | Vision affected by dazzling sun | | | | | |

| <u>Ref No</u> | <u>Date</u> | <u>Road</u> | <u>Accident Severity</u> | <u>Day of Week</u> | | | | |
|---|---------------------|---------------------|--|--------------------|--------------------|-------------------------|---|--|
| S031707 | 05/12/06 | A0435 | Slight | Tuesday | | | | |
| - A435 B Ham Rd Mappleborough Green o/s The Paddocks and 50m north of j/w | | | | | | | | |
| - X3400 | | | | | | | | |
| All vehs trav north. V3 stopped in crown of road waiting to turn rt into The Paddocks private drive. V2 stopped behind. V1 ran into rear of V2 which was pushed into rear of V3 | | | | | | | | |
| <u>East</u> | <u>North</u> | <u>Weather</u> | <u>Surface</u> | <u>Light</u> | <u>Time</u> | <u>No of Casualties</u> | | |
| 408606 | 267331 | Fine | Dry | Dark unlit | 1955 | | 3 | |
| <u>Vehicle No</u> | <u>and Type</u> | <u>Driver/Rider</u> | <u>Age</u> | <u>Direction</u> | <u>Breath Test</u> | <u>No. of Vehicles</u> | | |
| 1 Car | | Male | 28 | S to N | - ve | | | |
| Casualty | 1 Slight | Driver | Male | Age | 28 | | | |
| 2 Light Goods | | Male | 55 | S to N | + ve | | | |
| 3 Car | | Male | 48 | S to N | - ve | | | |
| | <u>Factor codes</u> | 308 V001 A | Following too close | | | | | |
| | | 406 V001 B | Failed to judge other person's path or speed | | | | | |
| | | 408 V003 B | Sudden braking | | | | | |
| | | 501 V002 A | Impaired by alcohol | | | | | |

Ref No Date Road Accident Severity Day of Week
S030250 24/02/07 A4023 Slight Saturday
- A4023 jw A435 redditch
- V1 leaving A435 on loop slip jnt with A4023 loses control spins and strike o/s barrier

| <u>East</u> | <u>North</u> | <u>Weather</u> | <u>Surface</u> | <u>Light</u> | <u>Time</u> | <u>No of Casualties</u> | | |
|------------------------|-----------------|---------------------|--------------------------------|------------------|--------------------|-------------------------|------|--|
| 408861 | 267771 | Fine | Wet | Dark lit | 1740 | | 2 | |
| <u>No. of Vehicles</u> | | | | | | | 1 | |
| <u>Vehicle No</u> | <u>and Type</u> | <u>Driver/Rider</u> | <u>Age</u> | <u>Direction</u> | <u>Breath Test</u> | | | |
| 1 Car | | Male | 20 | E to W | - ve | | Skid | |
| Casualty | 1 Slight | Driver | Male | Age | 20 | | | |
| Casualty | 2 Slight | Passenger | Female | Age | 20 | Front Seat | | |
| <u>Factor codes</u> | | 410 V001 A | Loss of control | | | | | |
| | | 103 V001 B | Slippery road (due to weather) | | | | | |

Ref No Date Road Accident Severity Day of Week
S030959 24/06/07 A4189 Slight Sunday
- A4189 Henley rd
- V2 turning right from A4189 into school, V1 came up behind V2 filed to see indicators and tried to o/take as V2 started turn causing collision

Overtaking on
offside

| <u>East</u> | <u>North</u> | <u>Weather</u> | <u>Surface</u> | <u>Light</u> | <u>Time</u> | <u>No of Casualties</u> | | |
|------------------------|-----------------|---------------------|--|------------------|--------------------|-------------------------|---|--|
| 408544 | 266745 | Fine | Dry | Light | 1525 | | 1 | |
| <u>No. of Vehicles</u> | | | | | | | 2 | |
| <u>Vehicle No</u> | <u>and Type</u> | <u>Driver/Rider</u> | <u>Age</u> | <u>Direction</u> | <u>Breath Test</u> | | | |
| 1 Car | | Male | | W to E | No contact | | | |
| 2 Car | | Male | 28 | W to S | No contact | | | |
| Casualty | 1 Slight | Passenger | Female | Age | 08 | Rear Seat | | |
| <u>Factor codes</u> | | 406 V001 A | Failed to judge other person's path or speed | | | | | |
| | | 405 V001 A | Failed to look properly | | | | | |

Ref No Date Road Accident Severity Day of Week
S030603 24/04/08 A4023 Serious Thursday
- A435 Slip Rd Coventry Highway
- V1 enters slip road, due to weather conditions fails to judge the bend and lost control

| <u>East</u> | <u>North</u> | <u>Weather</u> | <u>Surface</u> | <u>Light</u> | <u>Time</u> | <u>No of Casualties</u> | | |
|------------------------|-----------------|---------------------|--------------------------------|------------------|--------------------|-------------------------|------|--|
| 408731 | 267842 | Rain | Wet | Light | 0900 | | 1 | |
| <u>No. of Vehicles</u> | | | | | | | 1 | |
| <u>Vehicle No</u> | <u>and Type</u> | <u>Driver/Rider</u> | <u>Age</u> | <u>Direction</u> | <u>Breath Test</u> | | | |
| 1 Car | | Male | 29 | N to E | No contact | | Skid | |
| Casualty | 1 Serious | Driver | Male | Age | 29 | | | |
| <u>Factor codes</u> | | 410 V001 A | Loss of control | | | | | |
| | | 103 V001 A | Slippery road (due to weather) | | | | | |
| | | 603 V001 B | Nervous, uncertain or panic | | | | | |

Ref No Date Road Accident Severity Day of Week
S030834 28/06/08 A0435 Fatal Saturday
- A435 Birmingham Rd Studley
- V1 tvl NW on A435 , V1 exits RAB at Mappleborough Green and lost control and hit V2 tvl SW, V3 behind V2 could not stop and hit rear

| <u>East</u> | <u>North</u> | <u>Weather</u> | <u>Surface</u> | <u>Light</u> | <u>Time</u> | <u>No of Casualties</u> | | |
|------------------------|-----------------|---------------------|--|------------------|--------------------|-------------------------|------|--|
| 408442 | 266781 | Fine | Dry | Light | 1730 | | 2 | |
| <u>No. of Vehicles</u> | | | | | | | 3 | |
| <u>Vehicle No</u> | <u>and Type</u> | <u>Driver/Rider</u> | <u>Age</u> | <u>Direction</u> | <u>Breath Test</u> | | | |
| 1 Car | | Male | 76 | SW to NE | | | | |
| Casualty | 1 Fatal | Driver | Male | Age | 76 | | | |
| 2 Car | | Male | 54 | NE to SW | - ve | | Skid | |
| 3 Car | | Male | 49 | NE to SW | - ve | | Skid | |
| Casualty | 2 Slight | Driver | Male | Age | 49 | | | |
| <u>Factor codes</u> | | 505 V001 A | Physical or mental illness or disability | | | | | |
| | | 410 V001 A | Loss of control | | | | | |

Ref No Date Road Accident Severity Day of Week
S031558 19/11/08 A4023 Slight Wednesday

- A435 Coventry Highway
- V1 o/taking 2 vehs on slip road, hits gravel and loses control of m/bike
Overtaking on

| offside | | | | | | | | |
|---------------------|-----------------|---------------------|--------------------------------|------------------|--------------------|-------------------------|---|--|
| <u>East</u> | <u>North</u> | <u>Weather</u> | <u>Surface</u> | <u>Light</u> | <u>Time</u> | <u>No of Casualties</u> | | |
| 408731 | 268001 | Fine | Dry | Light | 1539 | | 1 | |
| <u>Vehicle No</u> | <u>and Type</u> | <u>Driver/Rider</u> | <u>Age</u> | <u>Direction</u> | <u>Breath Test</u> | <u>No. of Vehicles</u> | | |
| 1 | Motorcycle | Male | 60 | NE to W | - ve | | 1 | |
| Casualty | 1 Slight | Rider | Male | Age | 60 | | | |
| <u>Factor codes</u> | | 101 V001 A | Poor or defective road surface | | | | | |
| | | 410 V001 A | Loss of control | | | | | |

| <u>Ref No</u> | <u>Date</u> | <u>Road</u> | <u>Accident</u> | <u>Severity</u> | <u>Day of Week</u> | | |
|--|-----------------|---------------------|-----------------|------------------|--------------------|-------------------------|---|
| S031675 | 31/12/08 | A4023 | Slight | | Wednesday | | |
| - A4023 Coventry Highway, Redditch, slip road to A435 n/b | | | | | | | |
| - V1 trav N on A435 left c/way n/s onto A4023 slip road causing V2 to take evasive action. V2 left slip road n/s down embankment | | | | | | | |
| <u>East</u> | <u>North</u> | <u>Weather</u> | <u>Surface</u> | <u>Light</u> | <u>Time</u> | <u>No of Casualties</u> | |
| 408775 | 268033 | Fine | Frost/Ice | Dark lit | 0715 | | 2 |
| <u>Vehicle No</u> | <u>and Type</u> | <u>Driver/Rider</u> | <u>Age</u> | <u>Direction</u> | <u>Breath Test</u> | <u>No. of Vehicles</u> | |
| 1 | Car | Male | 39 | S to N | Not reqd | Skid | |
| Casualty | 1 Slight | Driver | Male | Age | 39 | | |
| 2 | Car | Female | 32 | W to N | - ve | | |

- End -

AccsMap - Accident Analysis System

Accidents between dates 01/08/2004 and 31/07/2009 (60) months
 Selection: Notes:
 Selected using Pre-defined Query : For Morgan Tucker

04DF39326 05/08/2004 Time 1730 Vehicles 1 Casualties 1 Serious
 E: 408160 N: 266850 First Road: U Road Type Single carriageway
 Speed limit: 40 Junction Detail: Not within 20m of junction Not applicable
 Crossing: Control None Facilities: None within 50m Road surface Wet/Damp
 Daylight: no street lighting Raining without high winds

Special Conditions at Site Oil or Diesel
 V1 LOSES CONTROL ON DIESEL AND MUD, WHILST NEG BEND, MOUNTED N/S COLL WITH LAMP POST AND OVERTURNING

Occurred on FAR MOOR LN, REDDITCH NR J/W ARDENS CLOSE

Vehicle Reference 1 Goods 7.5 tonnes mgw and over Going ahead right bend
 Vehicle movement from NE to NW Articulated On the main road
 Skidded and overturned
 Location at impact Not at, or within 20M of Jct First impact Front Hit vehicle:
 Breath test Negative Age of Driver 39 Male
 Casualty Ref: 1 Vehicle: 1 Age: 39 Male Driver/rider Severity: Serious

04DF39748 23/08/2004 Time 1755 Vehicles 1 Casualties 2 Slight
 E: 407840 N: 268080 First Road: U Road Type 1
 Speed limit: 40 Junction Detail: Roundabout Give way or controlled
 Crossing: Control None Facilities: None within 50m Road surface Wet/Damp
 Daylight: street lights present Raining without high winds

Special Conditions at Site None
 AS DR/V1 LEFT R/ABOUT HE LOST CONTROL OF VEH ON WET/SLIPPERY RD SURFACE, HE ATTEMPTED TO CORRECT BUT VEH LEFT RD TO N/S COLL/W TREE

Occurred on ALDERS DRIVE J/W A4023 COVENTRY HIGHWAY R/ABOUT NR MOONS MOAT IND EST REDDITCH

Vehicle Reference 1 Car Going ahead left bend
 Vehicle movement from NE to SW No tow / articulation Leaving the main road
 Skidded
 Location at impact Cleared junction or waiting/parked First impact Front Hit vehicle:
 Breath test Negative Age of Driver 18 Male
 Casualty Ref: 1 Vehicle: 1 Age: 15 Female Passenger Severity: Slight
 Casualty Ref: 2 Vehicle: 1 Age: 15 Female Passenger Severity: Slight

04DF39915 08/09/2004 Time 1248 Vehicles 1 Casualties 2 Serious
 E: 407970 N: 267230 First Road: U Road Type Single carriageway
 Speed limit: 40 Junction Detail: Not within 20m of junction Not applicable

Accidents between dates 01/08/2004 and 31/07/2009 (60) months
 Selection: Notes:
 Selected using Pre-defined Query : For Morgan Tucker

Crossing: Control None Facilities: None within 50m Road surface Dry
 Daylight:street lights present Fine without high winds

Special Conditions at Site None
 V1 NEG SWEEPING L/H/BEND LOSES CONTROL, SKIDDING OVER TO O/S VERGE COLL/W TREE

Occurred on ALDERS DR APP 218 MT NW J/W COSTERS LANE WINYATES GREEN REDDI TCH

| | | | | |
|-----------------------|------------------------------|------------|-----------------------|-------------------|
| Vehicle Reference | 1 | Car | Going ahead left bend | |
| Vehicle movement from | S | to NW | No tow / articulation | On the main road |
| | | | Skidded | |
| Location at impact | Not at, or within 20M of Jct | | First impact | Front |
| Breath test | Not applicable | | Age of Driver 51 | Female |
| Hit vehicle: | | | | |
| Casualty Ref: | 1 | Vehicle: 1 | Age: 51 | Female |
| | | | Driver/rider | Severity: Serious |
| Casualty Ref: | 2 | Vehicle: 1 | Age: 3 | Female |
| | | | Passenger | Severity: Serious |

04DF40432 29/09/2004 Time 1642 Vehicles 2 Casualties 1 Slight
 E: 408060 N: 266710 First Road: A 4189 Road Type 1
 Speed limit: 30 Junction Detail: Roundabout Give way or controlled
 Crossing: Control None Facilities: None within 50m Road surface Dry
 Daylight:street lights present Fine without high winds

Special Conditions at Site None
 V1 PULLED ONTO R/ABOUT & COLL/W V2 (P/CYCLE) WHICH WAS ALR EADY NEG R/ABOUT, KNOCKING RIDER OFF BIKE

Occurred on A4189 WARWICK HIGHWAY R/ABOUT J/W ALDERS DR MATCHBOROUGH REDDI TCH

| | | | | |
|-----------------------|---------------------------------|-------------|--|------------------|
| Vehicle Reference | 1 | Car | Going ahead left bend | |
| Vehicle movement from | E | to S | No tow / articulation | On the main road |
| | | | No skidding, jack-knifing or overturning | |
| Location at impact | Mid Junction - on roundabout or | | First impact | Front |
| Breath test | Negative | | Age of Driver 39 | Female |
| Hit vehicle: | 2 | | | |
| Vehicle Reference | 2 | Pedal Cycle | Going ahead other | |
| Vehicle movement from | N | to S | No tow / articulation | On the main road |
| | | | No skidding, jack-knifing or overturning | |
| Location at impact | Mid Junction - on roundabout or | | First impact | Back |
| Breath test | Not applicable | | Age of Driver 20 | Male |
| Hit vehicle: | 1 | | | |
| Casualty Ref: | 1 | Vehicle: 2 | Age: 20 | Male |
| | | | Driver/rider | Severity: Slight |

Accidents between dates 01/08/2004 and 31/07/2009 (60) months
 Selection: Notes:
 Selected using Pre-defined Query : For Morgan Tucker

04DF41651 25/11/2004 Time 1715 Vehicles 2 Casualties 1 Slight
 E: 407970 N: 266740 First Road: A 4189 Road Type 1
 Speed limit: 40 Junction Detail: Roundabout Give way or controlled
 Crossing: Control None Facilities: None within 50m Road surface Dry
 Darkness: street lights present and lit Fine without high winds

Special Conditions at Site None
 V2 STAT AT TR/ISLAND, WAITING TO TURN LEFT, V1 ON ITS O/S, SLIGHTLY TO ITS REAR, DR/V1 SEES RD IS CLEAR TO HER RIGHT, BEGAN TO MOVE OFF, ALSO TURNING LEFT, COLL WITH THE REAR END OF V2 WHICH WAS STILL STAT, IMPACT KNOCKED V2 OVER & RIDER & PILL/PASSENGER WH

Occurred on A4189 WARWICK HIGHWAY J/W ALDERS DRIVE, REDDITCH

Vehicle Reference 1 Car Turning left
 Vehicle movement from W to N No tow / articulation Leaving the main road
 No skidding, jack-knifing or overturning

Location at impact Jct Approach First impact Front Hit vehicle: 2
 Breath test Negative Age of Driver 32 Female

Vehicle Reference 2 Motor Cycle over 125 cc and up to 50 Waiting to turn left
 Vehicle movement from W to N No tow / articulation On the main road
 No skidding, jack-knifing or overturning

Location at impact Jct Approach First impact Back Hit vehicle: 1
 Breath test Negative Age of Driver 42 Male

Casualty Ref: 1 Vehicle: 2 Age: 42 Female Passenger Severity: Slight

04DF42068 19/12/2004 Time 1837 Vehicles 2 Casualties 1 Slight
 E: 407730 N: 268240 First Road: A 4023 Road Type Single carriageway
 Speed limit: 40 Junction Detail: Other Give way or controlled
 Crossing: Control None Facilities: None within 50m Road surface Wet/Damp
 Darkness: street lights present and lit Fine without high winds

Special Conditions at Site None
 V1 TURNED RGT ACROSS MAIN RD TO TURN INTO ENT/TO MACDONALD S, FAILING TO SEE ONCOMING V2 ROUNDING R/H/BEND RESULTING IN COLL

Occurred on A4023 MOONS MOAT DR J/W TURNING TO MCDONALDS AT IND EST CHURCH HILL REDDITCH

Vehicle Reference 1 Car Turning right
 Vehicle movement from SE to N No tow / articulation Leaving the main road
 No skidding, jack-knifing or overturning

Location at impact Mid Junction - on roundabout or First impact Front Hit vehicle: 2
 Breath test Negative Age of Driver 26 Male

Accidents between dates 01/08/2004 and 31/07/2009 (60) months
 Selection: Notes:
 Selected using Pre-defined Query : For Morgan Tucker

Vehicle Reference 2 Taxi/Private hire car Going ahead right bend
 Vehicle movement from SW to SE No tow / articulation On the main road
 No skidding, jack-knifing or overturning

Location at impact Mid Junction - on roundabout or First impact Front Hit vehicle: 1
 Breath test Not applicable Age of Driver 49 Male

Casualty Ref: 1 Vehicle: 2 Age: 49 Male Driver/rider Severity: Slight

05DF47498 03/10/2005 Time 1335 Vehicles 2 Casualties 1 Slight
 E: 408010 N: 267010 First Road: U Road Type Single carriageway
 Speed limit: 30 Junction Detail: T & Stag Jct Give way or controlled
 Crossing: Control None Facilities: None within 50m Road surface Dry
 Daylight:street lights present Fine without high winds

Special Conditions at Site None
 V2 SLOWS AND INDICATES TO TURN RT, V1 FOLLOWING FAILS TO REACT IN TIME COLLIDING REAR V2.

Occurred on ALLDERS DRIVE,REDDITCH J/W COSTERS LANE.

Vehicle Reference 1 Car Going ahead other
 Vehicle movement from N to S No tow / articulation
 No skidding, jack-knifing or overturning

Location at impact Jct Approach First impact Front Hit vehicle: 2
 Breath test Negative Age of Driver 21 Male

Casualty Ref: 1 Vehicle: 1 Age: 21 Male Driver/rider Severity: Slight

Vehicle Reference 2 Car Waiting to turn right
 Vehicle movement from N to W No tow / articulation
 No skidding, jack-knifing or overturning

Location at impact Jct Approach First impact Back Hit vehicle: 1
 Breath test Negative Age of Driver 34 Female

05DF48187 12/11/2005 Time 1700 Vehicles 1 Casualties 1 Slight
 E: 408210 N: 267560 First Road: U Road Type Single carriageway
 Speed limit: 30 Junction Detail: T & Stag Jct Give way or controlled
 Crossing: Control None Facilities: None within 50m Road surface Dry
 Darkness: street lights present and lit Fine without high winds

Special Conditions at Site None
 V1 REVERSING FAILS TO SEE CAS 1 STEP OFF PAVEMENT TO REAR OF V1.

Occurred on FURZE LANE REDDITCH OP J/W GATELEY CLOSE.

Accidents between dates 01/08/2004 and 31/07/2009 (60) months
 Selection: Notes:
 Selected using Pre-defined Query : For Morgan Tucker

Vehicle Reference 1 Car Reversing
 Vehicle movement from E to W No tow / articulation
 No skidding, jack-knifing or overturning

Location at impact Mid Junction - on roundabout or First impact Back Hit vehicle:
 Breath test Negative Age of Driver 29 Female

Casualty Ref: 1 Vehicle: 1 Age: 63 Male Pedestrian Severity: Slight

05DF48582 02/12/2005 Time 1227 Vehicles 2 Casualties 2 Slight
 E: 407850 N: 268230 First Road: U Road Type 1
 Speed limit: 40 Junction Detail: Roundabout Give way or controlled
 Crossing: Control None Facilities: None within 50m Road surface Wet/Damp
 Darkness: street lights present but unlit Fine without high winds

Special Conditions at Site None
 V2 WAITING TO PULL ONTO TRAFFIC ISLAND, IS HIT IN THE REAR BY V1

Occurred on MOONS MOAT DR J/W RAVENSBANK DR, REDDITCH

Vehicle Reference 1 Goods 7.5 tonnes mgw and over Stopping
 Vehicle movement from W to E No tow / articulation
 No skidding, jack-knifing or overturning

Location at impact Entering roundabout First impact Front Hit vehicle: 2
 Breath test Negative Age of Driver 28 Male

Vehicle Reference 2 Car Going ahead but held up
 Vehicle movement from W to E No tow / articulation
 No skidding, jack-knifing or overturning

Location at impact Jct Approach First impact Back Hit vehicle: 1
 Breath test Not applicable Age of Driver 23 Male

Casualty Ref: 1 Vehicle: 2 Age: 23 Male Driver/rider Severity: Slight

Casualty Ref: 2 Vehicle: 2 Age: 21 Male Passenger Severity: Slight

05DF49056 21/12/2005 Time 0800 Vehicles 2 Casualties 1 Slight
 E: 408010 N: 267010 First Road: U Road Type Single carriageway
 Speed limit: 40 Junction Detail: T & Stag Jct Give way or controlled
 Crossing: Control None Facilities: None within 50m Road surface Wet/Damp
 Darkness: street lights present and lit Raining without high winds

AccsMap - Accident Analysis System

Accidents between dates 01/08/2004 and 31/07/2009 (60) months
 Selection: Notes:
 Selected using Pre-defined Query : For Morgan Tucker

Special Conditions at Site None
 V2 TURNED RT FROM SIDE RD INTO PATH V1 ON MAIN RD.

Occurred on ALDERS DRIVE,REDDITCH J/W COSTERS LANE.

Vehicle Reference 1 Car
 Vehicle movement from S to N
 Going ahead other
 No tow / articulation
 No skidding, jack-knifing or overturning

Location at impact Jct Approach First impact Front Hit vehicle: 2
 Breath test Driver not contacted Age of Driver 22 Female

Casualty Ref: 1 Vehicle: 1 Age: 22 Female Driver/rider Severity: Slight

Vehicle Reference 2 Car
 Vehicle movement from W to S
 Turning right
 No tow / articulation
 No skidding, jack-knifing or overturning

Location at impact Entering main road First impact Offside Hit vehicle: 1
 Breath test Driver not contacted Age of Driver 17 Male

06DF49456 26/01/2006 Time 1930 Vehicles 2 Casualties 1 Slight
 E: 408060 N: 268020 First Road: U Road Type Single carriageway
 Speed limit: 40 Junction Detail: Not within 20m of junction Not applicable
 Crossing: Control None Facilities: None within 50m Road surface Wet/Damp
 Darkness: street lights present and lit Fine without high winds

Special Conditions at Site None
 V1 DRIVEN BY FOREIGN NATIONAL. IS TRAVELLING ON WRONG SIDE OF RD V2 TRAVELLING IN OP
 DIRECTION IS UNABLE TO AVOID COLLIDING V1.

Occurred on FARMOOR LANE,REDDITCH APPROX 50 M NE J/E REGENTS COURT.

Vehicle Reference 1 Car
 Vehicle movement from SW to E
 Going ahead right bend
 No tow / articulation
 No skidding, jack-knifing or overturning

Location at impact Not at, or within 20M of Jct First impact Front Hit vehicle: 2
 Breath test Negative Age of Driver 41 Male

Vehicle Reference 2 Car
 Vehicle movement from E to SW
 Going ahead left bend
 No tow / articulation
 No skidding, jack-knifing or overturning

Location at impact Not at, or within 20M of Jct First impact Front Hit vehicle: 1
 Breath test Negative Age of Driver 29 Male

Accidents between dates 01/08/2004 and 31/07/2009 (60) months
 Selection: Notes:
 Selected using Pre-defined Query : For Morgan Tucker

Casualty Ref: 1 Vehicle: 2 Age: 29 Male Driver/rider Severity: Slight

06DE49886 16/02/2006 Time 1907 Vehicles 1 Casualties 1 Slight
 E: 407620 N: 268170 First Road: A 4023 Road Type Dual carriageway
 Speed limit: 60 Junction Detail: Not within 20m of junction Not applicable
 Crossing: Control None Facilities: None within 50m Road surface Dry
 Darkness: street lights present and lit Fine without high winds

Special Conditions at Site None
 V1 FOR U/K REASON LOSES CONTROL MOUNTING N/S KERB COLL/W RD SIGN

Occurred on A4023 COVENTRY HIGHWAY APP 203 MT WB ALDERS DR ISLAND REDDITCH

Vehicle Reference 1 Car Going ahead other
 Vehicle movement from W to E No tow / articulation
 Skidded and overturned

Location at impact Not at, or within 20M of Jct First impact Front Hit vehicle:
 Breath test Not applicable Age of Driver 26 Male

Casualty Ref: 1 Vehicle: 1 Age: 26 Male Driver/rider Severity: Slight

06DE50316 08/03/2006 Time 0900 Vehicles 2 Casualties 1 Slight
 E: 408070 N: 266720 First Road: A 4189 Road Type Single carriageway
 Speed limit: 40 Junction Detail: Roundabout Give way or controlled
 Crossing: Control None Facilities: None within 50m Road surface Dry
 Daylight: no street lighting Fine without high winds

Special Conditions at Site None
 V2 STATIONARY WAITING TO ENTER ISLAND,V1 STATIONARY BEHIND V1 MOVES OFF MISTAKENLY BELIEVING
 V2 IS MOVING OFF AND A COLLISION OCCURS.

Occurred on A4189 WARWICK HIGHWAY REDDITCH J/W CLAYBROOK/ALDERS DRIVE TRAFFIC ISLAND.

Vehicle Reference 1 Car Starting
 Vehicle movement from E to W No tow / articulation
 No skidding, jack-knifing or overturning

Location at impact Jct Approach First impact Front Hit vehicle: 2
 Breath test Negative Age of Driver 50 Female

Vehicle Reference 2 Car Going ahead but held up
 Vehicle movement from E to W No tow / articulation
 No skidding, jack-knifing or overturning

Location at impact Jct Approach First impact Back Hit vehicle: 1
 Breath test Driver not contacted Age of Driver 36 Female

Accidents between dates 01/08/2004 and 31/07/2009 (60) months
 Selection: Notes:
 Selected using Pre-defined Query : For Morgan Tucker

Casualty Ref: 1 Vehicle: 2 Age: 36 Female Driver/rider Severity: Slight

06DE50417 16/03/2006 Time 1745 Vehicles 3 Casualties 1 Slight
 E: 407750 N: 267430 First Road: U Road Type Single carriageway
 Speed limit: 40 Junction Detail: T & Stag Jct Give way or controlled
 Crossing: Control None Facilities: None within 50m Road surface Wet/Damp
 Daylight:street lights present Raining without high winds

Special Conditions at Site None
 V1 SLOWS TO TURN RT OFF ALDERS DRIVE, V2 REACTS TOO LATE COLLIDING REAR V1. V1 IS SHUNTED INTO PATH V3 TRAVELLING IN OP DIRECTION.

Occurred on ALDERS DRIVE REDDITCH J/W TEN ACRES LANE.

Vehicle Reference 1 Car Stopping
 Vehicle movement from NW to SE No tow / articulation
 No skidding, jack-knifing or overturning

Location at impact Jct Approach First impact Back Hit vehicle: 2
 Breath test Negative Age of Driver 55 Female

Casualty Ref: 1 Vehicle: 1 Age: 15 Male Passenger Severity: Slight

Vehicle Reference 2 Car Going ahead other
 Vehicle movement from NW to SE No tow / articulation
 Skidded

Location at impact Jct Approach First impact Front Hit vehicle: 1
 Breath test Negative Age of Driver 18 Male

Vehicle Reference 3 Car Going ahead other
 Vehicle movement from SE to NW No tow / articulation
 No skidding, jack-knifing or overturning

Location at impact Cleared junction or waiting/parked First impact Offside Hit vehicle: 1
 Breath test Negative Age of Driver 20 Male

06DE51627 21/05/2006 Time 0240 Vehicles 1 Casualties 1 Slight
 E: 407900 N: 268210 First Road: A 4023 Road Type 1
 Speed limit: 70 Junction Detail: Roundabout Give way or controlled
 Crossing: Control None Facilities: None within 50m Road surface Wet/Damp
 Darkness: street lights present and lit Raining without high winds

Special Conditions at Site None
 INTOXICATED DR V1 ON SLIP OFF RD APPROACHING TRAFFIC ISLAND LOSES CONTROL V1. V1 ENTERS

Accidents between dates 01/08/2004 and 31/07/2009 (60) months
 Selection: Notes:
 Selected using Pre-defined Query : For Morgan Tucker

ISLAND TRAVELS ACROSS MOUTH OF 2 JCTS COMING TO REST AGAINST BARRIER. DR V1 FLEES FROM SCENE.

Occurred on A4023 COVENTRY HIGHWAY, REDDITCH EB SLIP OFF RD, J/W RAVENS BANK DRIVE, REDDITCH.

| | | | | | | |
|-----------------------|--------------------|---------------|-----------------------|------|--------------|------------------|
| Vehicle Reference | 1 | Car | Going ahead other | | | |
| Vehicle movement from | W | to NE | No tow / articulation | | | |
| | | | Skidded | | | |
| Location at impact | Leaving roundabout | First impact | Front | | Hit vehicle: | |
| Breath test | Positive | Age of Driver | 34 | | Male | |
| Casualty Ref: | 1 | Vehicle: 1 | Age: 28 | Male | Passenger | Severity: Slight |

06DE52415 12/07/2006 Time 2015 Vehicles 2 Casualties 2 Slight
 E: 407900 N: 268110 First Road: A 4023 Road Type Dual carriageway
 Speed limit: 70 Junction Detail: Roundabout Give way or controlled
 Crossing: Control None Facilities: None within 50m Road surface Dry
 Daylight:street lights present Fine without high winds

Special Conditions at Site None
 V2 WAITING TO ENTER TRAFFIC ISLAND IS STRUCK IN REAR BY V1

Occurred on A4023 COVENTRY HIGHWAY REDDITCH WB CW J/W WINYATES ISLAND

| | | | | | | |
|-----------------------|----------------------|---------------|--|--------|----------------|------------------|
| Vehicle Reference | 1 | Car | Going ahead other | | | |
| Vehicle movement from | E | to W | No tow / articulation | | | |
| | | | No skidding, jack-knifing or overturning | | | |
| Location at impact | Jct Approach | First impact | Front | | Hit vehicle: 2 | |
| Breath test | Driver not contacted | Age of Driver | 25 | | Male | |
| Vehicle Reference | 2 | Car | Going ahead but held up | | | |
| Vehicle movement from | E | to W | No tow / articulation | | | |
| | | | No skidding, jack-knifing or overturning | | | |
| Location at impact | Jct Approach | First impact | Back | | Hit vehicle: 1 | |
| Breath test | Driver not contacted | Age of Driver | 58 | | Female | |
| Casualty Ref: | 1 | Vehicle: 2 | Age: 58 | Female | Driver/rider | Severity: Slight |
| Casualty Ref: | 2 | Vehicle: 2 | Age: 55 | Female | Passenger | Severity: Slight |

06DE85255 21/11/2006 Time 1345 Vehicles 2 Casualties 1 Slight
 E: 407820 N: 268200 First Road: A 4023 Road Type 1
 Speed limit: 70 Junction Detail: Roundabout Give way or controlled

AccsMap - Accident Analysis System

Accidents between dates 01/08/2004 and 31/07/2009 (60) months
 Selection: Notes:
 Selected using Pre-defined Query : For Morgan Tucker

Crossing: Control None Facilities: None within 50m Road surface Wet/Damp
 Daylight:street lights present Fine without high winds

Special Conditions at Site None
 V2 AND 1 MOVING OFF FROM STATIONARY ONTO ISLAND, V1 FITTED WITH NEW CLUTCH LURCHES FORWARD COLLIDING REAR V2.

Occurred on A4023 COVENTRY HIGHWAY EB SLIP OFF RD, REDDITCH J/W CHURCHILL ROUNDABOUT.

Vehicle Reference 1 Car Starting
 Vehicle movement from W to NE No tow / articulation
 No skidding, jack-knifing or overturning

Location at impact Entering main road First impact Back Hit vehicle: 2
 Breath test Driver not contacted Age of Driver 44 Female

Casualty Ref: 1 Vehicle: 1 Age: 44 Female Driver/rider Severity: Slight

Vehicle Reference 2 Car Starting
 Vehicle movement from W to NE No tow / articulation
 No skidding, jack-knifing or overturning

Location at impact Entering main road First impact Front Hit vehicle: 1
 Breath test Driver not contacted Age of Driver 25 Male

07DE85669 09/02/2007 Time 1330 Vehicles 2 Casualties 1 Slight
 E: 407160 N: 268090 First Road: U Road Type Single carriageway
 Speed limit: 30 Junction Detail: T & Stag Jct Give way or controlled
 Crossing: Control None Facilities: None within 50m Road surface Snow
 Darkness: street lights present and lit Snowing without high winds

Special Conditions at Site None
 V2 TURNED RGT ONTO MAIN RD CUTTING ACROSS ONCOMING V1'S PATH RESULTING IN COLL

Occurred on MOONS MOAT DR J/W WINYATES WAY REDDITCH

Vehicle Reference 1 Car Going ahead other
 Vehicle movement from SW to NE No tow / articulation
 No skidding, jack-knifing or overturning

Location at impact Mid Junction - on roundabout or First impact Front Hit vehicle: 2
 Breath test Not requested Age of Driver 23 Female

Casualty Ref: 1 Vehicle: 1 Age: 23 Female Driver/rider Severity: Slight

Vehicle Reference 2 Car Turning right
 Vehicle movement from NW to SW No tow / articulation
 No skidding, jack-knifing or overturning

Accidents between dates 01/08/2004 and 31/07/2009 (60) months
 Selection: Notes:
 Selected using Pre-defined Query : For Morgan Tucker

Location at impact Entering main road First impact Offside Hit vehicle: 1
 Breath test Not requested Age of Driver 39 Male

07DE86161 08/05/2007 Time 2110 Vehicles 2 Casualties 3 Serious
 E: 407680 N: 268220 First Road: U Road Type Single carriageway
 Speed limit: 40 Junction Detail: T & Stag Jct Give way or controlled
 Crossing: Control None Facilities: None within 50m Road surface Dry
 Darkness: street lights present and lit Fine without high winds

Special Conditions at Site None
 V1 ON MAIN RD TURNS RGT INTO JCT CUTTING ACROSS ONCOMING V2S PATH RESULTING IN COLL

Occurred on MOONS MOAT DR J/W BLACK SOILS RD REDDITCH

Vehicle Reference 1 Car Turning right
 Vehicle movement from SW to S No tow / articulation
 No skidding, jack-knifing or overturning

Location at impact Leaving main road First impact Nearside Hit vehicle: 2
 Breath test Negative Age of Driver 18 Male

Casualty Ref: 3 Vehicle: 1 Age: 16 Female Passenger Severity: Serious

Vehicle Reference 2 Car Going ahead other
 Vehicle movement from NE to SW No tow / articulation
 No skidding, jack-knifing or overturning

Location at impact Mid Junction - on roundabout or First impact Front Hit vehicle: 1
 Breath test Negative Age of Driver 17 Male

Casualty Ref: 1 Vehicle: 2 Age: 17 Female Passenger Severity: Slight

Casualty Ref: 2 Vehicle: 2 Age: 17 Female Passenger Severity: Slight

07DE86692 13/07/2007 Time 1056 Vehicles 2 Casualties 1 Slight
 E: 408020 N: 266930 First Road: U Road Type Single carriageway
 Speed limit: 40 Junction Detail: T & Stag Jct Give way or controlled
 Crossing: Control None Facilities: None within 50m Road surface Wet/Damp
 Daylight:street lights present Raining without high winds

Special Conditions at Site None
 V2 TURNS RT OFF MAIN RD ACROSS PATH V1 WHICH IS UNABLE TO AVOID A COLLISION.

Occurred on ALDERS DRIVE, REDDITCH J/W FARMORE LANE..

Vehicle Reference 1 Car Going ahead other

Accidents between dates 01/08/2004 and 31/07/2009 (60) months
 Selection: Notes:
 Selected using Pre-defined Query : For Morgan Tucker

Vehicle movement from N to S No tow / articulation
 No skidding, jack-knifing or overturning

Location at impact Jct Approach First impact Front Hit vehicle: 2
 Breath test Negative Age of Driver 58 Male

Vehicle Reference 2 Car Turning right
 Vehicle movement from S to E No tow / articulation
 No skidding, jack-knifing or overturning

Location at impact Leaving main road First impact Nearside Hit vehicle: 1
 Breath test Negative Age of Driver 41 Male

Casualty Ref: 1 Vehicle: 2 Age: 41 Male Driver/rider Severity: Slight

07DE86865 07/09/2007 Time 0907 Vehicles 2 Casualties 1 Slight
 E: 408100 N: 268140 First Road: A 4023 Road Type Slip road
 Speed limit: 60 Junction Detail: Not within 20m of junction Not applicable
 Crossing: Control None Facilities: None within 50m Road surface Dry
 Daylight:street lights present Fine without high winds

Special Conditions at Site None
 V2 TRAV BEH V1 ON SLIP RD, V1 BRAKES HEAVILY FOR NO APPARANT REASON CAUSING V2 TO TAKE
 EVASIVE ACTION, LOSES CONTROL COLL/W N/S LAMP POST, V1 FAILED TO STOP

Occurred on A4023 APP 190 MT EB SLIP RD MOONS MOAT ISLAND REDDITCH

Vehicle Reference 1 Car Stopping
 Vehicle movement from W to E No tow / articulation
 No skidding, jack-knifing or overturning

Location at impact Not at, or within 20M of Jct First impact Did not impact Hit vehicle:
 Breath test Driver not contacted Age of Driver Not traced

Vehicle Reference 2 Car Stopping
 Vehicle movement from W to E No tow / articulation
 Skidded

Location at impact Not at, or within 20M of Jct First impact Nearside Hit vehicle:
 Breath test Not applicable Age of Driver 20 Female

Casualty Ref: 1 Vehicle: 2 Age: 20 Female Driver/rider Severity: Slight

07DE86867 07/09/2007 Time 1805 Vehicles 2 Casualties 1 Slight
 E: 408230 N: 267290 First Road: U Road Type Single carriageway

Accidents between dates 01/08/2004 and 31/07/2009 (60) months
Selection: Notes:
 Selected using Pre-defined Query : For Morgan Tucker

Speed limit: 30 Junction Detail: Not within 20m of junction Not applicable
 Crossing: Control None Facilities: None within 50m Road surface Dry
 Daylight:street lights present Fine without high winds

Special Conditions at Site None
 V1 WAS TURNING INTO PARKING BAY O/S OWN ADDRESS WHEN 10 YR OLD RIDER V2 P/CYCLE RODE INTO
 V1'S PATH RESULTING IN COLL

Occurred on NEWENT CLOSE O/S NO 28 , REDDITCH

Vehicle Reference 1 Car Stopping
 Vehicle movement from E to N No tow / articulation
 No skidding, jack-knifing or overturning

Location at impact Not at, or within 20M of Jct First impact Front Hit vehicle: 2
 Breath test Negative Age of Driver 35 Male

Vehicle Reference 2 Pedal Cycle Going ahead other
 Vehicle movement from NE to SW No tow / articulation
 No skidding, jack-knifing or overturning

Location at impact Not at, or within 20M of Jct First impact Front Hit vehicle: 1
 Breath test Not applicable Age of Driver 10 Female

Casualty Ref: 1 Vehicle: 2 Age: 10 Female Driver/rider Severity: Slight

07DE87058 12/10/2007 Time 1700 Vehicles 2 Casualties 1 Slight
 E: 407121 N: 268046 First Road: A 4023 Road Type Dual carriageway
 Speed limit: 60 Junction Detail: Not within 20m of junction Not applicable
 Crossing: Control None Facilities: None within 50m Road surface Dry
 Daylight:street lights present Fine without high winds

Special Conditions at Site None
 DR/V2 PULLS OVER AS U/K VEH HAD BROKEN DOWN ON O/S LANE AND IS STRUCK IN REAR BY V1 FOL BEH,
 V1 FAILS TO STOP

Occurred on A4023 COVENTRY HIGHWAY WB APP 350 MT EB B4491 SLIP OFF RD REDDITCH

Vehicle Reference 1 Car Going ahead other
 Vehicle movement from E to W No tow / articulation
 No skidding, jack-knifing or overturning

Location at impact Not at, or within 20M of Jct First impact Front Hit vehicle: 2
 Breath test Driver not contacted Age of Driver Not traced

Vehicle Reference 2 Car Stopping
 Vehicle movement from E to W No tow / articulation
 No skidding, jack-knifing or overturning

Accidents between dates 01/08/2004 and 31/07/2009 (60) months
 Selection: Notes:
 Selected using Pre-defined Query : For Morgan Tucker

Location at impact Not at, or within 20M of Jct First impact Back Hit vehicle: 1
 Breath test Driver not contacted Age of Driver 33 Female

Casualty Ref: 1 Vehicle: 2 Age: 33 Female Driver/rider Severity: Slight

08DE88331 04/05/2008 Time 0310 Vehicles 1 Casualties 1 Slight
 E: 407950 N: 267250 First Road: U Road Type Single carriageway
 Speed limit: 40 Junction Detail: Not within 20m of junction Not applicable
 Crossing: Control None Facilities: None within 50m Road surface Dry
 Darkness: street lights present and lit Fine without high winds

Special Conditions at Site None
 INTOXICATED DR/V1 LOSES CONTROL OF VEH ON L/H/BEND LEAVING RD TO O/S COLL/W LAMP POST
 O/TURNING INTO HEDGE, DRIVER LEFT SCENE BUT FOUND BY POL LATER

Occurred on OPP NO.50 ALDERS DR REDDITCH

Vehicle Reference 1 Car Going ahead left bend
 Vehicle movement from S to NW No tow / articulation
 Skidded and overturned

Location at impact Not at, or within 20M of Jct First impact Front Hit vehicle:
 Breath test Positive Age of Driver 39 Male

Casualty Ref: 1 Vehicle: 1 Age: 39 Male Driver/rider Severity: Slight

08DE88588 05/06/2008 Time 0830 Vehicles 2 Casualties 1 Slight
 E: 407818 N: 268197 First Road: A 4023 Road Type Dual carriageway
 Speed limit: 70 Junction Detail: Roundabout Give way or controlled
 Crossing: Control None Facilities: None within 50m Road surface Dry
 Daylight:street lights present Fine without high winds

Special Conditions at Site None
 V1 WAITING TO ENTER TRAFFIC ISLAND IS STRUCK IN REAR BY V2 .

Occurred on A4023 COVENTRY HIGHWAY REDDITCH J/W MOONS MOAT ISLAND

Vehicle Reference 1 Car Going ahead but held up
 Vehicle movement from W to E No tow / articulation
 No skidding, jack-knifing or overturning

Location at impact Jct Approach First impact Back Hit vehicle: 2
 Breath test Driver not contacted Age of Driver 36 Female

Casualty Ref: 1 Vehicle: 1 Age: 36 Female Driver/rider Severity: Slight

Vehicle Reference 2 Car Going ahead other

Accidents between dates 01/08/2004 and 31/07/2009 (60) months
 Selection: Notes:
 Selected using Pre-defined Query : For Morgan Tucker

Vehicle movement from W to E No tow / articulation
 No skidding, jack-knifing or overturning

Location at impact Jct Approach First impact Front Hit vehicle: 1
 Breath test Negative Age of Driver 27 Female

08DE89194 24/10/2008 Time 2340 Vehicles 3 Casualties 1 Slight
 E: 407090 N: 268150 First Road: U Road Type Single carriageway
 Speed limit: 40 Junction Detail: Not within 20m of junction Not applicable
 Crossing: Control None Facilities: None within 50m Road surface Wet/Damp
 Darkness: street lights present and lit Raining without high winds

Special Conditions at Site None
 DR/V1 APPARANTLY USING MOBILE WHILE DRIVING COLL/W PARKED V2 AND PARKED V3, V1 THEN DRIVES
 OFF WITHOUT EXCHANGING DETAILS

Occurred on WINYATES WAY APP 40 MT EB WINYATES WAY REDDITCH

Vehicle Reference 1 Car Overtaking stat vehicle O/S
 Vehicle movement from E to W No tow / articulation
 No skidding, jack-knifing or overturning

Location at impact Not at, or within 20M of Jct First impact Front Hit vehicle: 2
 Breath test Driver not contacted Age of Driver Not traced

Vehicle Reference 2 Car Parked
 Vehicle movement from Park to Parked No tow / articulation
 No skidding, jack-knifing or overturning

Location at impact Not at, or within 20M of Jct First impact Back Hit vehicle: 1
 Breath test Not requested Age of Driver 49 Male

Casualty Ref: 1 Vehicle: 2 Age: 49 Male Driver/rider Severity: Slight

Vehicle Reference 3 Car Parked
 Vehicle movement from Park to Parked No tow / articulation
 No skidding, jack-knifing or overturning

Location at impact Not at, or within 20M of Jct First impact Back Hit vehicle: 1
 Breath test Not requested Age of Driver 29 Male

09D900988 04/02/2009 Time 1313 Vehicles 2 Casualties 1 Slight
 E: 408150 N: 266713 First Road: A 4189 Road Type Dual carriageway
 Speed limit: 70 Junction Detail: Not within 20m of junction Not applicable

Accidents between dates 01/08/2004 and 31/07/2009 (60) months
 Selection: Notes:
 Selected using Pre-defined Query : For Morgan Tucker

Crossing: Control None Facilities: None within 50m Road surface Wet/Damp
 Daylight:street lights present Fine without high winds

Special Conditions at Site None
 V1 HAS FAILED TO SEE V2 STAT IN LN 1 & HAS ATTEMPTED TO MOVE TO LN 2, WHILE DOING SO HAS COLL/ W REAR OF V2

Occurred on A4189 WARWICK H/WAY,APPROX 85 MT E CLAYBROOK DR REDDITCH

Vehicle Reference 1 Goods over 3.5 tonnes and under 7. Going ahead other
 Vehicle movement from E to W No tow / articulation
 No skidding, jack-knifing or overturning

Location at impact Not at, or within 20M of Jct First impact Front Hit vehicle:
 Breath test Negative Age of Driver 27 Male

Vehicle Reference 2 Car Parked
 Vehicle movement from Park to Parked No tow / articulation
 No skidding, jack-knifing or overturning

Location at impact Not at, or within 20M of Jct First impact Back Hit vehicle:
 Breath test Negative Age of Driver 26 Female

Casualty Ref: 1 Vehicle: 2 Age: 26 Female Driver/rider Severity: Slight

09D903514 24/06/2009 Time 2044 Vehicles 1 Casualties 2 Slight
 E: 408170 N: 268090 First Road: A 4023 Road Type Dual carriageway
 Speed limit: 70 Junction Detail: Not within 20m of junction Not applicable
 Crossing: Control None Facilities: None within 50m Road surface Dry
 Daylight:street lights present Fine without high winds

Special Conditions at Site None
 V1 IS A MOTORCYCLE WHICH HAD A RIDER AND PILLION PASSENGER. FOLLOWING THE BEND IN THE ROAD RIDER LOST CONTROL OF V1 CAUSING THE DRIVER AND PILLION PASSENGER TO FALL FROM VEHICLE

Occurred on A4023 COVENTRY HIGHWAY 260 M E MOONS MOAT ISLAND

Vehicle Reference 1 Motorcycle over 500cc Going ahead other
 Vehicle movement from E to W No tow / articulation
 Skidded

Location at impact Not at, or within 20M of Jct First impact Offside Hit vehicle:
 Breath test Negative Age of Driver 26 Male

Casualty Ref: 1 Vehicle: 1 Age: 26 Male Driver/rider Severity: Slight

Casualty Ref: 2 Vehicle: 1 Age: 30 Female Passenger Severity: Slight

AccsMap - Accident Analysis System

Accidents between dates 01/08/2004 and 31/07/2009 (60) months
 Selection: Notes:
 Selected using Pre-defined Query : For Morgan Tucker

09D903977 22/07/2009 Time 1705 Vehicles 2 Casualties 2 Slight
 E: 407690 N: 268220 First Road: U Road Type Single carriageway
 Speed limit: 30 Junction Detail: Other Give way or controlled
 Crossing: Control None Facilities: None within 50m Road surface Dry
 Daylight:street lights present Fine without high winds

Special Conditions at Site None
 HEAD ON COLLISION ON MOONS MOAT DRIVE CAUSED BY ONE VEHICLE (V2) BEING ON THE WRONG SIDE OF THE ROAD. V1 & V2 COLLIDED HEAD ON.

Occurred on MOONS MOAT DRIVE,REDDITCH,J/W BLACK SOIL DRIVE.,

Vehicle Reference 1 Car Going ahead other
 Vehicle movement from E to W No tow / articulation
 No skidding, jack-knifing or overturning

Location at impact Jct Approach First impact Front Hit vehicle:
 Breath test Negative Age of Driver 44 Female

Casualty Ref: 1 Vehicle: 1 Age: 44 Female Driver/rider Severity: Slight

Vehicle Reference 2 Car Going ahead other
 Vehicle movement from W to E No tow / articulation
 No skidding, jack-knifing or overturning

Location at impact Cleared junction or waiting/parked First impact Front Hit vehicle:
 Breath test Negative Age of Driver 41 Female

Casualty Ref: 2 Vehicle: 2 Age: 41 Female Driver/rider Severity: Slight

Accidents between dates 01/08/2004 and 31/07/2009 (60) months

Selection:

Selected using Pre-defined Query :

Notes:

For Morgan Tucker

Accidents involving:

Casualties:

| | Fatal | Serious | Slight | Total | | Fatal | Serious | Slight | Total |
|--|-------|---------|--------|-------|------------------|-------|---------|--------|-------|
| Motor vehicles only (excluding 2-wheels) | 0 | 3 | 22 | 25 | Vehicle driver | 0 | 2 | 19 | 21 |
| | | | | | Passenger | 0 | 2 | 10 | 12 |
| 2-wheeled motor vehicles | 0 | 0 | 2 | 2 | Motorcycle rider | 0 | 0 | 1 | 1 |
| | | | | | Cyclist | 0 | 0 | 2 | 2 |
| Pedal cycles | 0 | 0 | 2 | 2 | Pedestrian | 0 | 0 | 1 | 1 |
| Horses & other | 0 | 0 | 0 | 0 | Other | 0 | 0 | 0 | 0 |
| Total | 0 | 3 | 26 | 29 | Total | 0 | 4 | 33 | 37 |

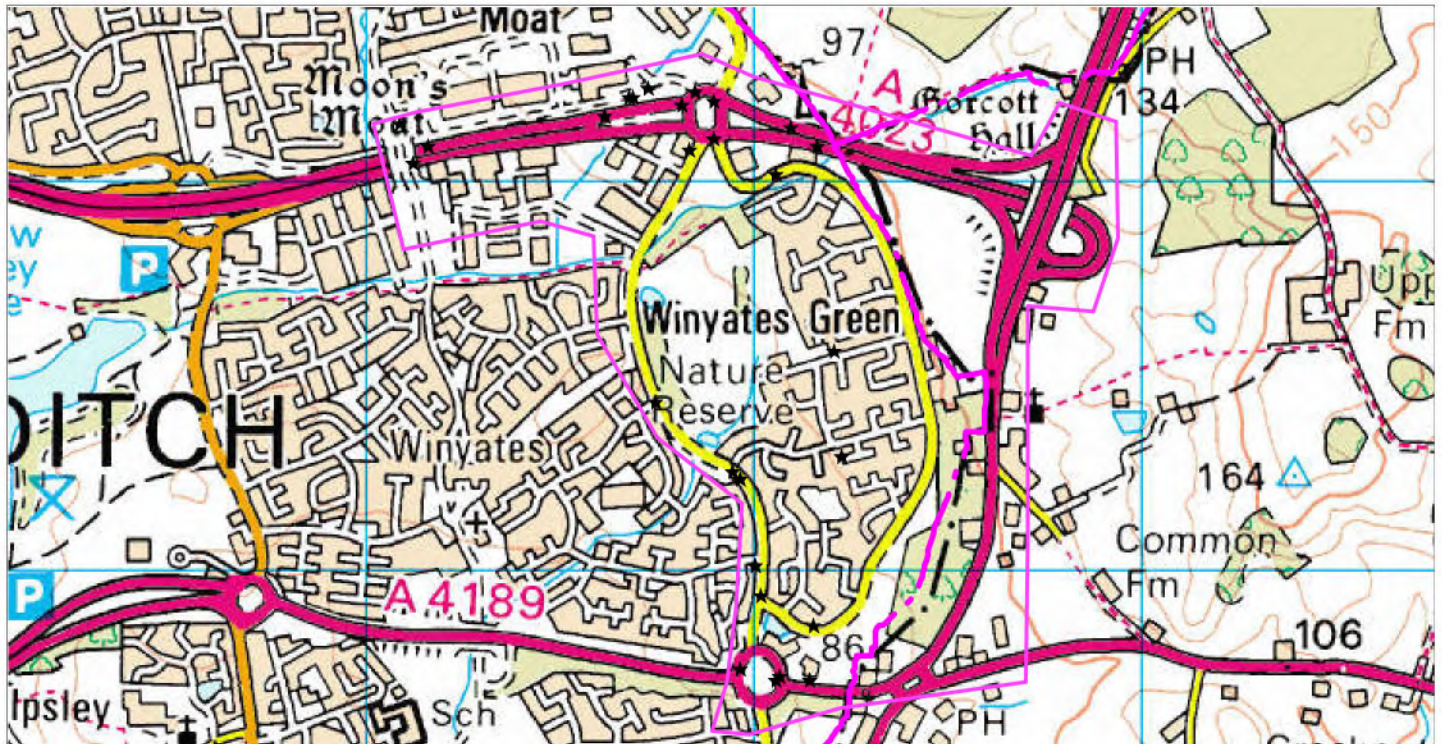

APPENDIX D

2009 Base Traffic Flows
Speed Data

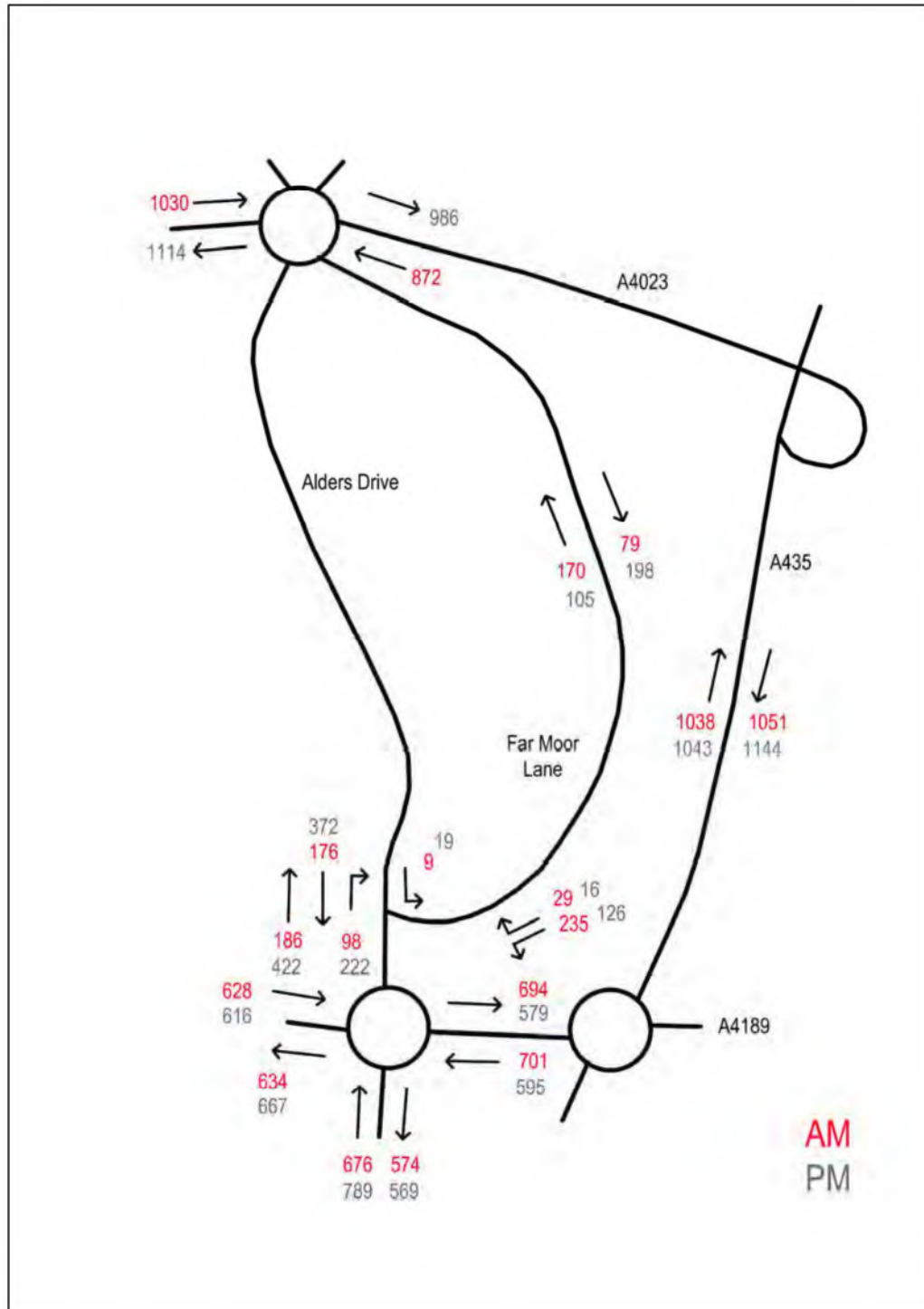

| | | | | | | |
|---|--|---|------------------------|--|-----------|------|
| Reproduced by permission of Ordnance Survey on behalf of HMSO © Crown Copyright 2006. All rights reserved. Ordnance Survey Licence number 100046211 | | DO NOT SCALE. USE FIGURED DIMENSIONS ONLY. CHECK ON SITE AND REPORT ANY DISCREPANCIES TO MORGAN TUCKER. | | Rev | Amendment | Date |
| Client Redditch Borough Council | Drawn By TS | Checked By LB | Approved By BS |  AURA Commerce and Technology Centre, Manners Road Newark, Nottinghamshire, NG24 1BS Tel:- 01636 610 766 Fax:- 01636 610 786 E-Mail:- info@morgantucker.co.uk www.morgantucker.co.uk | | |
| Project Title Proposed Diversification Park Development | Date 28/09/09 | Scale NTS | Purpose Information | | | |
| Drawing Title 2009 Base Traffic Flow | Drawing Number JN835 - NWK - 002 | | Rev | | | |
| Copyright © Morgan Tucker | | | | | | |

Site No: 00141883

Site Reference: 408615267415

A435 South of Gorcott Hill (SCM + Perm Monitor)
From 01/06/2009 To 30/06/2009

Vehicle Count Summary

All Channels

| Time Begin | Mon | Tue | Wed | Thu | Fri | Sat | Sun | 5-Day Av | 7-Day Av |
|------------|-------|-------|-------|-------|-------|-------|-------|----------|----------|
| 0:00 | 115 | 126 | 128 | 154 | 147 | 225 | 243 | 134 | 163 |
| 1:00 | 50 | 58 | 67 | 68 | 75 | 140 | 150 | 64 | 87 |
| 2:00 | 39 | 41 | 51 | 53 | 50 | 81 | 95 | 47 | 59 |
| 3:00 | 43 | 45 | 55 | 53 | 64 | 81 | 82 | 52 | 60 |
| 4:00 | 102 | 100 | 92 | 102 | 97 | 88 | 77 | 99 | 94 |
| 5:00 | 257 | 247 | 249 | 254 | 232 | 139 | 170 | 248 | 221 |
| 6:00 | 661 | 679 | 700 | 674 | 636 | 257 | 303 | 670 | 559 |
| 7:00 | 1665 | 1706 | 1748 | 1705 | 1597 | 452 | 390 | 1684 | 1323 |
| 8:00 | 2070 | 2133 | 2139 | 2105 | 2001 | 712 | 529 | 2090 | 1670 |
| 9:00 | 1405 | 1499 | 1499 | 1476 | 1446 | 975 | 901 | 1465 | 1314 |
| 10:00 | 1198 | 1234 | 1217 | 1286 | 1247 | 1210 | 1286 | 1236 | 1240 |
| 11:00 | 1227 | 1213 | 1247 | 1298 | 1370 | 1383 | 1523 | 1271 | 1323 |
| 12:00 | 1222 | 1255 | 1298 | 1303 | 1503 | 1447 | 1650 | 1316 | 1383 |
| 13:00 | 1242 | 1319 | 1346 | 1320 | 1581 | 1416 | 1562 | 1362 | 1398 |
| 14:00 | 1289 | 1337 | 1365 | 1389 | 1598 | 1359 | 1438 | 1396 | 1396 |
| 15:00 | 1401 | 1523 | 1541 | 1532 | 1741 | 1316 | 1404 | 1548 | 1494 |
| 16:00 | 1687 | 1821 | 1842 | 1832 | 2091 | 1356 | 1348 | 1855 | 1711 |
| 17:00 | 2106 | 2232 | 2199 | 2239 | 2161 | 1230 | 1235 | 2187 | 1915 |
| 18:00 | 1547 | 1618 | 1660 | 1667 | 1652 | 1087 | 1026 | 1629 | 1465 |
| 19:00 | 831 | 945 | 1009 | 1009 | 1042 | 814 | 830 | 967 | 926 |
| 20:00 | 540 | 641 | 630 | 685 | 668 | 564 | 631 | 633 | 623 |
| 21:00 | 403 | 523 | 493 | 520 | 480 | 418 | 459 | 484 | 471 |
| 22:00 | 297 | 390 | 379 | 414 | 382 | 387 | 274 | 372 | 360 |
| 23:00 | 211 | 230 | 237 | 269 | 360 | 368 | 170 | 261 | 264 |
| 12H,7-19 | 18059 | 18891 | 19101 | 19152 | 19988 | 13944 | 14294 | 19038 | 17633 |
| 16H,6-22 | 20494 | 21680 | 21931 | 22040 | 22815 | 15998 | 16518 | 21792 | 20211 |
| 18H,6-24 | 21003 | 22300 | 22546 | 22723 | 23557 | 16753 | 16961 | 22426 | 20835 |
| 24H,0-24 | 21609 | 22917 | 23188 | 23405 | 24224 | 17507 | 17778 | 23068 | 21518 |
| Am | 8:00 | 8:00 | 7:30 | 8:00 | 8:00 | 11:00 | 11:00 | - | - |
| Peak | 2070 | 2134 | 2165 | 2104 | 2002 | 1383 | 1523 | 2095 | 1912 |
| Pm | 17:00 | 17:00 | 17:00 | 17:00 | 16:30 | 12:00 | 12:00 | - | - |
| Peak | 2106 | 2232 | 2198 | 2238 | 2216 | 1448 | 1650 | 2198 | 2013 |

Includes Local Events. Includes Global Events:

Printed at 14:42:06 on 2 Sep 2009

A435 South of Gorcott Hill (SCM + Perm Monitor)
From 01/06/2009 To 30/06/2009

Vehicle Count Summary

Channel: Northbound

| Time Begin | Mon | Tue | Wed | Thu | Fri | Sat | Sun | 5-Day Av | 7-Day Av |
|------------|--------------|---------------|---------------|---------------|---------------|--------------|--------------|-----------|----------|
| 0:00 | 50 | 54 | 62 | 72 | 67 | 95 | 111 | 61 | 73 |
| 1:00 | 22 | 24 | 25 | 26 | 36 | 64 | 68 | 27 | 38 |
| 2:00 | 18 | 21 | 22 | 25 | 22 | 37 | 39 | 22 | 26 |
| 3:00 | 21 | 21 | 25 | 24 | 26 | 36 | 30 | 23 | 26 |
| 4:00 | 64 | 53 | 49 | 55 | 56 | 49 | 37 | 55 | 52 |
| 5:00 | 161 | 145 | 142 | 148 | 128 | 69 | 50 | 145 | 120 |
| 6:00 | 455 | 436 | 446 | 428 | 390 | 140 | 86 | 431 | 340 |
| 7:00 | 1001 | 995 | 998 | 984 | 905 | 232 | 143 | 977 | 751 |
| 8:00 | 1038 | 1053 | 1062 | 1035 | 1004 | 355 | 238 | 1038 | 826 |
| 9:00 | 731 | 766 | 773 | 751 | 760 | 492 | 429 | 756 | 672 |
| 10:00 | 574 | 590 | 584 | 631 | 631 | 576 | 578 | 602 | 595 |
| 11:00 | 604 | 592 | 612 | 633 | 622 | 598 | 669 | 613 | 619 |
| 12:00 | 607 | 623 | 635 | 641 | 680 | 628 | 750 | 637 | 652 |
| 13:00 | 598 | 647 | 658 | 637 | 689 | 614 | 755 | 646 | 657 |
| 14:00 | 614 | 630 | 645 | 675 | 728 | 586 | 747 | 658 | 661 |
| 15:00 | 682 | 741 | 749 | 740 | 842 | 603 | 746 | 751 | 729 |
| 16:00 | 800 | 878 | 878 | 903 | 985 | 610 | 758 | 889 | 830 |
| 17:00 | 993 | 1044 | 1038 | 1075 | 1067 | 602 | 668 | 1043 | 927 |
| 18:00 | 652 | 659 | 703 | 689 | 751 | 478 | 573 | 691 | 644 |
| 19:00 | 385 | 398 | 431 | 416 | 433 | 357 | 440 | 413 | 409 |
| 20:00 | 251 | 293 | 295 | 299 | 291 | 251 | 339 | 286 | 288 |
| 21:00 | 186 | 241 | 213 | 234 | 201 | 196 | 241 | 215 | 216 |
| 22:00 | 135 | 178 | 172 | 188 | 167 | 176 | 131 | 168 | 164 |
| 23:00 | 91 | 102 | 106 | 121 | 144 | 167 | 74 | 113 | 115 |
| 12H,7-19 | 8894 | 9218 | 9337 | 9394 | 9663 | 6373 | 7052 | 9301 | 8562 |
| 16H,6-22 | 10171 | 10585 | 10722 | 10771 | 10977 | 7317 | 8160 | 10645 | 9815 |
| 18H,6-24 | 10397 | 10865 | 11000 | 11079 | 11289 | 7660 | 8364 | 10926 | 10093 |
| 24H,0-24 | 10733 | 11183 | 11326 | 11429 | 11622 | 8008 | 8700 | 11258 | 10429 |
| Am Peak | 7:30 1118 | 7:30 1098 | 7:30 1132 | 7:30 1094 | 7:30 1033 | 10:30 601 | 11:00 669 | - 1095 | - 964 |
| Pm Peak | 17:00 993 | 17:00 1044 | 17:00 1038 | 17:00 1076 | 17:00 1068 | 12:30 632 | 14:30 758 | - 1044 | - 944 |

Site No: 00141883

Site Reference: 408615267415

A435 South of Gorcott Hill (SCM + Perm Monitor)
From 01/06/2009 To 30/06/2009

Vehicle Count Summary

Channel: Southbound

| Time Begin | Mon | Tue | Wed | Thu | Fri | Sat | Sun | 5-Day Av | 7-Day Av |
|------------|---------------|---------------|---------------|---------------|---------------|--------------|--------------|-----------|-----------|
| 0:00 | 65 | 72 | 66 | 82 | 78 | 131 | 132 | 73 | 89 |
| 1:00 | 28 | 35 | 41 | 43 | 40 | 76 | 81 | 37 | 49 |
| 2:00 | 21 | 20 | 29 | 27 | 29 | 44 | 56 | 25 | 32 |
| 3:00 | 23 | 24 | 30 | 29 | 39 | 47 | 52 | 29 | 35 |
| 4:00 | 38 | 47 | 43 | 47 | 41 | 38 | 40 | 43 | 42 |
| 5:00 | 96 | 102 | 107 | 106 | 104 | 70 | 120 | 103 | 101 |
| 6:00 | 205 | 243 | 254 | 245 | 247 | 118 | 215 | 239 | 218 |
| 7:00 | 664 | 710 | 750 | 721 | 692 | 220 | 249 | 707 | 572 |
| 8:00 | 1032 | 1080 | 1077 | 1069 | 997 | 357 | 292 | 1051 | 843 |
| 9:00 | 675 | 735 | 727 | 725 | 686 | 482 | 472 | 710 | 643 |
| 10:00 | 624 | 644 | 633 | 655 | 616 | 635 | 707 | 634 | 645 |
| 11:00 | 623 | 622 | 634 | 667 | 748 | 785 | 854 | 659 | 705 |
| 12:00 | 615 | 631 | 662 | 662 | 823 | 819 | 899 | 679 | 730 |
| 13:00 | 643 | 673 | 688 | 683 | 893 | 802 | 807 | 716 | 741 |
| 14:00 | 675 | 707 | 720 | 715 | 870 | 774 | 692 | 737 | 736 |
| 15:00 | 719 | 782 | 792 | 792 | 899 | 713 | 658 | 797 | 765 |
| 16:00 | 887 | 943 | 964 | 929 | 1107 | 746 | 591 | 966 | 881 |
| 17:00 | 1113 | 1188 | 1161 | 1163 | 1093 | 628 | 566 | 1144 | 987 |
| 18:00 | 895 | 959 | 956 | 978 | 902 | 610 | 454 | 938 | 822 |
| 19:00 | 446 | 547 | 577 | 594 | 609 | 458 | 390 | 555 | 517 |
| 20:00 | 289 | 348 | 335 | 386 | 377 | 312 | 293 | 347 | 334 |
| 21:00 | 218 | 283 | 280 | 286 | 280 | 222 | 218 | 269 | 255 |
| 22:00 | 162 | 212 | 207 | 226 | 215 | 211 | 142 | 204 | 196 |
| 23:00 | 121 | 129 | 130 | 149 | 216 | 200 | 96 | 149 | 149 |
| 12H,7-19 | 9165 | 9674 | 9764 | 9759 | 10325 | 7571 | 7242 | 9737 | 9071 |
| 16H,6-22 | 10323 | 11094 | 11209 | 11269 | 11838 | 8681 | 8358 | 11146 | 10396 |
| 18H,6-24 | 10605 | 11436 | 11546 | 11644 | 12269 | 9093 | 8597 | 11500 | 10741 |
| 24H,0-24 | 10876 | 11735 | 11862 | 11976 | 12601 | 9499 | 9078 | 11810 | 11089 |
| Am Peak | 8:00 1032 | 8:00 1080 | 8:00 1077 | 8:00 1069 | 8:00 997 | 11:00 785 | 11:00 854 | - 1051 | - 985 |
| Pm Peak | 17:00 1113 | 17:00 1188 | 17:00 1161 | 17:00 1163 | 16:30 1154 | 12:00 820 | 12:00 899 | - 1156 | - 1071 |

Includes Local Events, Includes Global Events

Printed at 14:42:00 on 2 Sep 2009

A435 South of Gorcott Hill (SCM + Perm Monitor)
From 01/06/2009 To 30/06/2009

Speed Summary (All Days)-Limit 40 Mph

All Channels

| Time Begin | Total Vol. | 85th %ile | Mean Ave. | Std. Dev. | Bin 1 <26Mph | Bin 2 26-<31 | Bin 3 31-<36 | Bin 4 36-<41 | Bin 5 41-<46 | Bin 6 46-<51 | Bin 7 51-<56 | Bin 8 56-<61 | Bin 9 61-<66 | Bin 10 66-<71 | Bin 11 71-<76 | Bin 12 76-<81 | Bin 13 =>81 |
|------------|---------------|---------------|---------------|--------------|--------------|--------------|--------------|--------------|--------------|--------------|--------------|--------------|--------------|---------------|---------------|---------------|-------------|
| 0:00 | 162 | 50.6 | 43.3 | 7.4 | 0 | 2 | 19 | 51 | 42 | 25 | 13 | 6 | 3 | 2 | 0 | 0 | 0 |
| 1:00 | 86 | 52.5 | 44.5 | 7.8 | 0 | 1 | 8 | 24 | 23 | 15 | 9 | 4 | 2 | 0 | 0 | 0 | 0 |
| 2:00 | 58 | 53.0 | 44.9 | 8.1 | 0 | 0 | 5 | 16 | 14 | 11 | 6 | 3 | 1 | 0 | 0 | 0 | 0 |
| 3:00 | 61 | 54.5 | 45.9 | 8.5 | 0 | 0 | 5 | 14 | 15 | 12 | 8 | 4 | 2 | 1 | 0 | 0 | 0 |
| 4:00 | 94 | 53.6 | 45.6 | 7.7 | 0 | 0 | 5 | 24 | 23 | 21 | 11 | 5 | 2 | 1 | 0 | 0 | 0 |
| 5:00 | 221 | 53.8 | 45.8 | 7.6 | 0 | 1 | 9 | 53 | 62 | 46 | 28 | 12 | 5 | 2 | 0 | 0 | 0 |
| 6:00 | 558 | 50.0 | 43.5 | 6.6 | 0 | 1 | 33 | 187 | 180 | 90 | 42 | 15 | 5 | 2 | 0 | 0 | 0 |
| 7:00 | 1323 | 44.9 | 39.8 | 5.3 | 6 | 18 | 229 | 615 | 333 | 91 | 24 | 6 | 2 | 0 | 0 | 0 | 0 |
| 8:00 | 1670 | 43.2 | 38.0 | 5.5 | 31 | 67 | 423 | 764 | 300 | 67 | 15 | 4 | 1 | 0 | 0 | 0 | 0 |
| 9:00 | 1315 | 43.0 | 37.8 | 5.6 | 33 | 52 | 344 | 603 | 216 | 51 | 12 | 3 | 0 | 0 | 0 | 0 | 0 |
| 10:00 | 1239 | 42.4 | 37.7 | 5.2 | 17 | 48 | 358 | 580 | 182 | 41 | 10 | 2 | 0 | 0 | 0 | 0 | 0 |
| 11:00 | 1323 | 42.2 | 37.4 | 5.4 | 31 | 57 | 377 | 612 | 190 | 42 | 10 | 2 | 0 | 0 | 0 | 0 | 0 |
| 12:00 | 1383 | 42.5 | 37.6 | 5.3 | 24 | 55 | 398 | 637 | 206 | 46 | 11 | 3 | 0 | 0 | 0 | 0 | 0 |
| 13:00 | 1398 | 42.6 | 37.8 | 5.2 | 18 | 53 | 388 | 660 | 214 | 50 | 12 | 2 | 0 | 0 | 0 | 0 | 0 |
| 14:00 | 1396 | 42.6 | 37.9 | 5.1 | 15 | 46 | 395 | 663 | 212 | 50 | 12 | 2 | 0 | 0 | 0 | 0 | 0 |
| 15:00 | 1494 | 42.8 | 38.0 | 5.1 | 19 | 43 | 401 | 720 | 240 | 54 | 12 | 3 | 0 | 0 | 0 | 0 | 0 |
| 16:00 | 1711 | 42.6 | 38.0 | 5.0 | 13 | 58 | 460 | 837 | 268 | 58 | 14 | 2 | 0 | 0 | 0 | 0 | 0 |
| 17:00 | 1914 | 43.0 | 37.9 | 5.4 | 38 | 77 | 486 | 898 | 327 | 69 | 15 | 4 | 0 | 0 | 0 | 0 | 0 |
| 18:00 | 1466 | 44.7 | 39.5 | 5.4 | 10 | 30 | 267 | 693 | 333 | 93 | 29 | 7 | 2 | 0 | 0 | 0 | 0 |
| 19:00 | 926 | 46.1 | 40.7 | 6.1 | 9 | 12 | 130 | 394 | 240 | 93 | 34 | 10 | 2 | 0 | 0 | 0 | 0 |
| 20:00 | 622 | 48.2 | 41.8 | 6.4 | 3 | 6 | 66 | 250 | 170 | 77 | 32 | 12 | 4 | 2 | 0 | 0 | 0 |
| 21:00 | 471 | 48.4 | 41.8 | 6.7 | 1 | 5 | 63 | 184 | 120 | 56 | 28 | 9 | 4 | 2 | 0 | 0 | 0 |
| 22:00 | 361 | 48.0 | 41.3 | 6.8 | 2 | 6 | 58 | 141 | 85 | 39 | 19 | 8 | 2 | 2 | 0 | 0 | 0 |
| 23:00 | 263 | 49.2 | 42.0 | 7.1 | 0 | 4 | 38 | 95 | 64 | 34 | 17 | 7 | 3 | 1 | 0 | 0 | 0 |
| 12H,7-19 | 17632 | 43.2 | 38.1 | 5.3 | 255 | 604 | 4525 | 8282 | 3021 | 712 | 176 | 40 | 5 | 0 | 0 | 0 | 0 |
| 16H,6-22 | 20209 | 43.9 | 38.5 | 5.6 | 268 | 628 | 4817 | 9297 | 3731 | 1028 | 312 | 86 | 20 | 6 | 0 | 0 | 0 |
| 18H,6-24 | 20833 | 44.0 | 38.6 | 5.6 | 270 | 638 | 4913 | 9533 | 3880 | 1101 | 348 | 101 | 25 | 9 | 0 | 0 | 0 |
| 24H,0-24 | 21515 | 44.3 | 38.8 | 5.8 | 270 | 642 | 4964 | 9715 | 4059 | 1231 | 423 | 135 | 40 | 15 | 0 | 0 | 0 |
| Am Peak | 8:00 1670 | 3:00 54.5 | 3:00 45.9 | 3:00 8.5 | 8:30 37 | 8:00 67 | 8:00 422 | 8:00 764 | 7:00 333 | 6:30 104 | 6:00 42 | 6:00 15 | 5:30 7 | 5:30 3 | 5:30 1 | 5:30 0 | 9:00 0 |
| Pm Peak | 17:00 1914 | 23:00 49.2 | 23:00 42.0 | 23:00 7.1 | 17:00 38 | 17:00 77 | 16:30 511 | 16:30 900 | 17:30 345 | 18:30 98 | 19:30 35 | 20:00 12 | 20:00 4 | 20:30 1 | 21:00 1 | 20:30 0 | 20:30 0 |

Site No: 00141883

Site Reference: 408615267415

A435 South of Gorcott Hill (SCM + Perm Monitor)
From 01/06/2009 To 30/06/2009

Speed Summary (All Days)-Limit 40 Mph

Channel: Northbound

| Time Begin | Total Vol. | 85th %ile | Mean Ave. | Std. Dev. | Bin 1 <26Mph | Bin 2 26-<31 | Bin 3 31-<36 | Bin 4 36-<41 | Bin 5 41-<46 | Bin 6 46-<51 | Bin 7 51-<56 | Bin 8 56-<61 | Bin 9 61-<66 | Bin 10 66-<71 | Bin 11 71-<76 | Bin 12 76-<81 | Bin 13 =>81 |
|------------|--------------|---------------|---------------|--------------|--------------|--------------|--------------|--------------|--------------|--------------|--------------|--------------|--------------|---------------|---------------|---------------|-------------|
| 0:00 | 73 | 50.6 | 43.1 | 8.0 | 0 | 2 | 10 | 23 | 17 | 12 | 6 | 2 | 1 | 0 | 0 | 0 | 0 |
| 1:00 | 37 | 52.0 | 44.2 | 7.8 | 0 | 0 | 4 | 10 | 9 | 6 | 4 | 2 | 0 | 0 | 0 | 0 | 0 |
| 2:00 | 26 | 51.0 | 44.2 | 7.9 | 0 | 0 | 3 | 6 | 6 | 5 | 2 | 1 | 0 | 0 | 0 | 0 | 0 |
| 3:00 | 26 | 52.0 | 44.5 | 7.8 | 0 | 0 | 3 | 6 | 7 | 5 | 2 | 2 | 1 | 0 | 0 | 0 | 0 |
| 4:00 | 52 | 51.3 | 44.4 | 7.2 | 0 | 0 | 3 | 15 | 15 | 10 | 5 | 2 | 0 | 0 | 0 | 0 | 0 |
| 5:00 | 120 | 53.2 | 45.7 | 7.2 | 0 | 0 | 5 | 27 | 36 | 26 | 15 | 6 | 2 | 1 | 0 | 0 | 0 |
| 6:00 | 340 | 50.0 | 43.7 | 6.2 | 0 | 1 | 18 | 101 | 120 | 61 | 26 | 8 | 3 | 1 | 0 | 0 | 0 |
| 7:00 | 751 | 45.4 | 40.7 | 5.1 | 5 | 6 | 79 | 337 | 242 | 63 | 15 | 3 | 1 | 0 | 0 | 0 | 0 |
| 8:00 | 827 | 44.6 | 39.7 | 5.0 | 7 | 13 | 114 | 410 | 223 | 48 | 10 | 2 | 0 | 0 | 0 | 0 | 0 |
| 9:00 | 672 | 43.6 | 38.0 | 5.9 | 22 | 27 | 150 | 303 | 133 | 29 | 7 | 2 | 0 | 0 | 0 | 0 | 0 |
| 10:00 | 595 | 43.0 | 38.1 | 5.1 | 7 | 19 | 151 | 287 | 103 | 22 | 4 | 2 | 0 | 0 | 0 | 0 | 0 |
| 11:00 | 618 | 43.0 | 37.9 | 5.5 | 15 | 22 | 148 | 296 | 107 | 22 | 6 | 2 | 0 | 0 | 0 | 0 | 0 |
| 12:00 | 652 | 43.1 | 38.1 | 5.2 | 10 | 22 | 164 | 309 | 117 | 24 | 5 | 2 | 0 | 0 | 0 | 0 | 0 |
| 13:00 | 657 | 43.2 | 38.2 | 5.1 | 8 | 19 | 164 | 315 | 117 | 27 | 5 | 2 | 0 | 0 | 0 | 0 | 0 |
| 14:00 | 660 | 43.0 | 38.1 | 5.1 | 9 | 18 | 170 | 318 | 115 | 24 | 5 | 1 | 0 | 0 | 0 | 0 | 0 |
| 15:00 | 729 | 42.8 | 38.0 | 5.1 | 10 | 21 | 192 | 349 | 125 | 25 | 4 | 0 | 0 | 0 | 0 | 0 | 0 |
| 16:00 | 829 | 42.9 | 38.1 | 4.8 | 8 | 25 | 206 | 411 | 147 | 27 | 6 | 0 | 0 | 0 | 0 | 0 | 0 |
| 17:00 | 927 | 43.6 | 38.6 | 5.1 | 12 | 26 | 193 | 456 | 195 | 37 | 7 | 1 | 0 | 0 | 0 | 0 | 0 |
| 18:00 | 643 | 45.0 | 39.9 | 5.6 | 8 | 11 | 95 | 294 | 172 | 47 | 13 | 3 | 0 | 0 | 0 | 0 | 0 |
| 19:00 | 409 | 45.7 | 40.2 | 6.2 | 8 | 7 | 63 | 168 | 108 | 37 | 13 | 2 | 1 | 0 | 0 | 0 | 0 |
| 20:00 | 289 | 46.9 | 41.2 | 6.0 | 1 | 4 | 38 | 117 | 79 | 31 | 12 | 4 | 2 | 0 | 0 | 0 | 0 |
| 21:00 | 216 | 47.2 | 41.2 | 6.4 | 0 | 2 | 34 | 88 | 54 | 22 | 11 | 4 | 2 | 0 | 0 | 0 | 0 |
| 22:00 | 164 | 46.7 | 40.7 | 6.5 | 0 | 3 | 30 | 64 | 38 | 17 | 7 | 2 | 1 | 0 | 0 | 0 | 0 |
| 23:00 | 114 | 48.0 | 41.2 | 6.7 | 0 | 3 | 20 | 42 | 27 | 13 | 6 | 2 | 1 | 0 | 0 | 0 | 0 |
| 12H,7-19 | 8560 | 43.8 | 38.6 | 5.3 | 121 | 229 | 1826 | 4086 | 1796 | 395 | 87 | 19 | 2 | 0 | 0 | 0 | 0 |
| 16H,6-22 | 9814 | 44.3 | 39.0 | 5.5 | 130 | 243 | 1979 | 4560 | 2157 | 546 | 149 | 38 | 10 | 1 | 0 | 0 | 0 |
| 18H,6-24 | 10092 | 44.4 | 39.0 | 5.5 | 130 | 249 | 2029 | 4666 | 2222 | 576 | 162 | 42 | 12 | 1 | 0 | 0 | 0 |
| 24H,0-24 | 10426 | 44.6 | 39.2 | 5.7 | 130 | 250 | 2056 | 4753 | 2312 | 640 | 196 | 57 | 16 | 2 | 0 | 0 | 0 |
| Am Peak | 7:30 849 | 5:00 53.2 | 5:00 45.7 | 0:30 8.6 | 9:00 22 | 9:00 27 | 10:00 151 | 8:00 410 | 7:30 249 | 6:30 72 | 6:00 26 | 6:00 8 | 5:30 3 | 5:30 1 | 5:30 1 | 5:30 0 | 9:00 0 |
| Pm Peak | 17:00 927 | 23:00 48.0 | 20:30 41.4 | 23:00 6.7 | 17:00 12 | 16:30 27 | 16:30 216 | 17:00 456 | 17:30 200 | 18:00 47 | 18:00 13 | 20:00 4 | 21:00 1 | 21:00 1 | 21:30 0 | 20:30 0 | 20:30 0 |

Includes Local Events, Includes Global Events

Printed at 14:43:10 on 2 Sep 2009

A435 South of Gorcott Hill (SCM + Perm Monitor)
From 01/06/2009 To 30/06/2009

Speed Summary (All Days)-Limit 40 Mph

Channel: Southbound

| Time Begin | Total Vol. | 85th %ile | Mean Ave. | Std. Dev. | Bin 1 <26Mph | Bin 2 26-<31 | Bin 3 31-<36 | Bin 4 36-<41 | Bin 5 41-<46 | Bin 6 46-<51 | Bin 7 51-<56 | Bin 8 56-<61 | Bin 9 61-<66 | Bin 10 66-<71 | Bin 11 71-<76 | Bin 12 76-<81 | Bin 13 =>81 |
|------------|------------|-----------|-----------|-----------|--------------|--------------|--------------|--------------|--------------|--------------|--------------|--------------|--------------|---------------|---------------|---------------|-------------|
| 0:00 | 90 | 50.4 | 43.5 | 7.6 | 0 | 1 | 9 | 29 | 25 | 14 | 6 | 3 | 2 | 0 | 0 | 0 | 0 |
| 1:00 | 49 | 52.4 | 44.7 | 7.0 | 0 | 0 | 3 | 14 | 14 | 8 | 5 | 2 | 1 | 0 | 0 | 0 | 0 |
| 2:00 | 32 | 53.5 | 45.5 | 7.6 | 0 | 0 | 2 | 9 | 8 | 6 | 4 | 2 | 1 | 0 | 0 | 0 | 0 |
| 3:00 | 34 | 55.3 | 46.9 | 8.4 | 0 | 0 | 2 | 8 | 8 | 7 | 4 | 2 | 2 | 0 | 0 | 0 | 0 |
| 4:00 | 42 | 55.1 | 47.0 | 8.4 | 0 | 0 | 2 | 9 | 10 | 10 | 6 | 3 | 2 | 1 | 0 | 0 | 0 |
| 5:00 | 100 | 54.2 | 46.0 | 7.6 | 0 | 0 | 4 | 27 | 26 | 20 | 13 | 6 | 3 | 1 | 0 | 0 | 0 |
| 6:00 | 218 | 50.0 | 43.1 | 6.9 | 0 | 0 | 16 | 86 | 60 | 28 | 15 | 7 | 2 | 1 | 0 | 0 | 0 |
| 7:00 | 572 | 43.5 | 38.6 | 5.2 | 2 | 12 | 149 | 278 | 91 | 28 | 9 | 3 | 0 | 0 | 0 | 0 | 0 |
| 8:00 | 844 | 40.6 | 36.3 | 5.3 | 24 | 55 | 309 | 354 | 77 | 19 | 5 | 2 | 0 | 0 | 0 | 0 | 0 |
| 9:00 | 643 | 42.0 | 37.5 | 5.2 | 10 | 25 | 194 | 300 | 84 | 21 | 6 | 2 | 0 | 0 | 0 | 0 | 0 |
| 10:00 | 645 | 41.5 | 37.3 | 5.1 | 9 | 30 | 208 | 294 | 79 | 19 | 5 | 2 | 0 | 0 | 0 | 0 | 0 |
| 11:00 | 705 | 41.2 | 37.0 | 5.3 | 15 | 35 | 229 | 315 | 84 | 19 | 6 | 2 | 0 | 0 | 0 | 0 | 0 |
| 12:00 | 731 | 41.5 | 37.2 | 5.3 | 15 | 33 | 235 | 328 | 89 | 22 | 7 | 2 | 0 | 0 | 0 | 0 | 0 |
| 13:00 | 742 | 41.9 | 37.5 | 5.2 | 10 | 34 | 223 | 345 | 96 | 23 | 6 | 2 | 0 | 0 | 0 | 0 | 0 |
| 14:00 | 736 | 42.1 | 37.7 | 5.0 | 6 | 29 | 225 | 345 | 97 | 26 | 8 | 2 | 0 | 0 | 0 | 0 | 0 |
| 15:00 | 765 | 42.7 | 38.0 | 5.1 | 8 | 22 | 209 | 371 | 114 | 29 | 7 | 2 | 0 | 0 | 0 | 0 | 0 |
| 16:00 | 881 | 42.2 | 37.8 | 5.0 | 6 | 33 | 255 | 425 | 120 | 31 | 9 | 2 | 0 | 0 | 0 | 0 | 0 |
| 17:00 | 987 | 42.0 | 37.2 | 5.6 | 26 | 52 | 293 | 441 | 131 | 32 | 8 | 2 | 0 | 0 | 0 | 0 | 0 |
| 18:00 | 822 | 44.3 | 39.2 | 5.3 | 3 | 18 | 171 | 400 | 162 | 47 | 16 | 4 | 1 | 0 | 0 | 0 | 0 |
| 19:00 | 518 | 46.8 | 41.1 | 5.9 | 2 | 5 | 66 | 226 | 131 | 56 | 21 | 8 | 2 | 0 | 0 | 0 | 0 |
| 20:00 | 335 | 49.0 | 42.4 | 6.6 | 2 | 2 | 28 | 134 | 90 | 46 | 20 | 8 | 2 | 0 | 0 | 0 | 0 |
| 21:00 | 255 | 49.2 | 42.3 | 6.8 | 1 | 3 | 29 | 96 | 66 | 33 | 17 | 6 | 2 | 0 | 0 | 0 | 0 |
| 22:00 | 197 | 48.8 | 41.8 | 7.1 | 0 | 2 | 28 | 75 | 47 | 24 | 12 | 4 | 2 | 0 | 0 | 0 | 0 |
| 23:00 | 149 | 49.8 | 42.6 | 7.2 | 0 | 1 | 18 | 53 | 38 | 20 | 11 | 5 | 2 | 0 | 0 | 0 | 0 |
| 12H,7-19 | 9073 | 42.2 | 37.6 | 5.3 | 134 | 378 | 2700 | 4196 | 1224 | 316 | 92 | 27 | 1 | 0 | 0 | 0 | 0 |
| 16H,6-22 | 10399 | 43.3 | 38.1 | 5.6 | 139 | 387 | 2839 | 4738 | 1571 | 479 | 165 | 56 | 9 | 1 | 0 | 0 | 0 |
| 18H,6-24 | 10745 | 43.5 | 38.2 | 5.7 | 139 | 390 | 2885 | 4866 | 1656 | 523 | 188 | 65 | 13 | 1 | 0 | 0 | 0 |
| 24H,0-24 | 11092 | 43.9 | 38.4 | 5.9 | 139 | 391 | 2907 | 4962 | 1747 | 587 | 226 | 83 | 24 | 3 | 0 | 0 | 0 |
| Am Peak | 8:00 | 3:30 | 3:30 | 3:30 | 8:00 | 8:00 | 8:00 | 8:00 | 7:00 | 6:30 | 6:00 | 6:00 | 5:30 | 5:30 | 4:30 | 5:00 | 2:00 |
| Peak | 843 | 55.4 | 47.1 | 8.7 | 24 | 55 | 309 | 354 | 91 | 32 | 16 | 8 | 3 | 2 | 0 | 0 | 0 |
| Pm Peak | 17:00 | 23:00 | 23:00 | 23:00 | 17:00 | 17:00 | 16:30 | 16:30 | 18:00 | 18:30 | 19:30 | 20:00 | 20:00 | 20:00 | 19:30 | 20:30 | 22:30 |
| Peak | 987 | 49.8 | 42.6 | 7.2 | 26 | 51 | 295 | 453 | 162 | 56 | 22 | 8 | 3 | 1 | 0 | 0 | 0 |

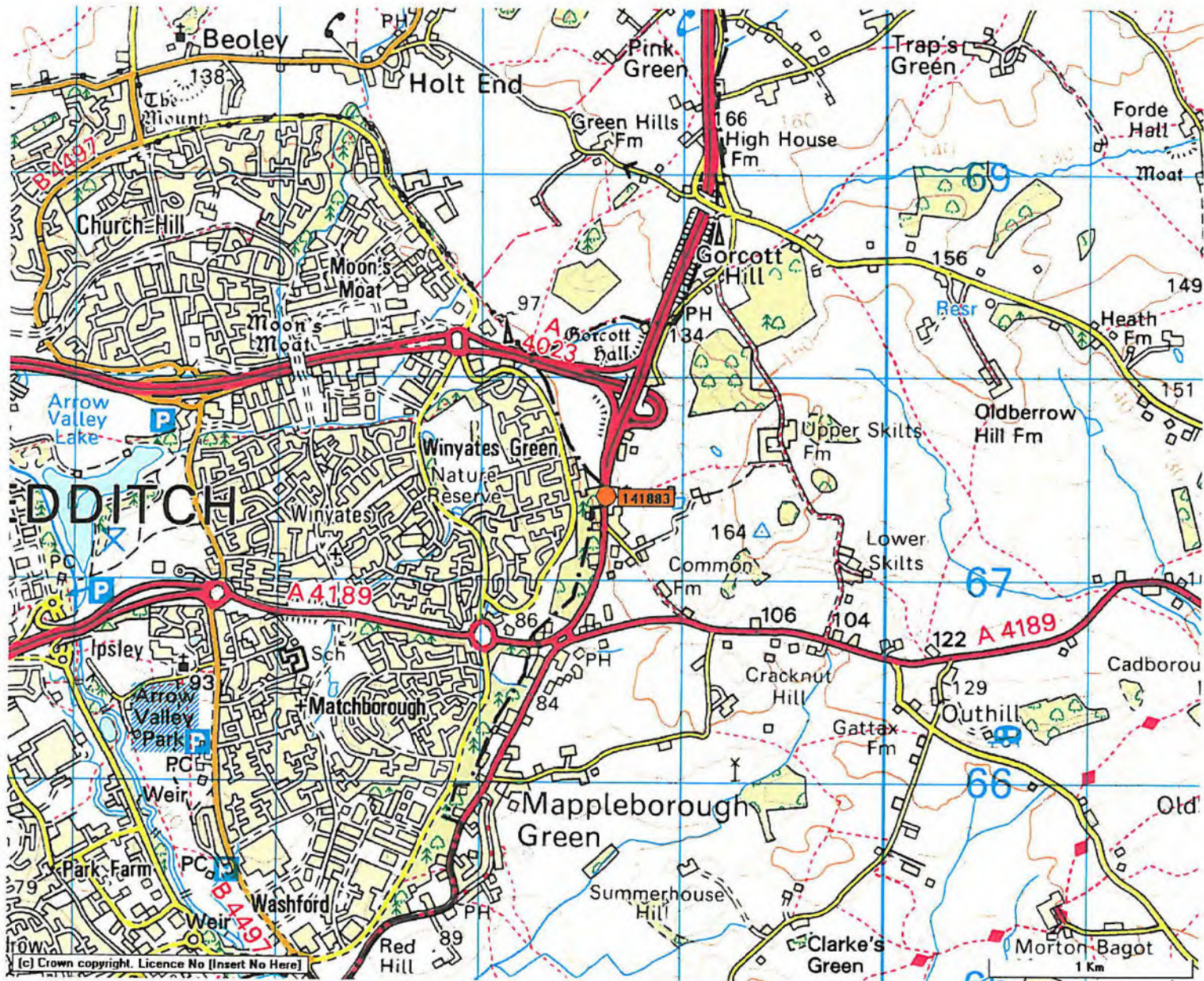

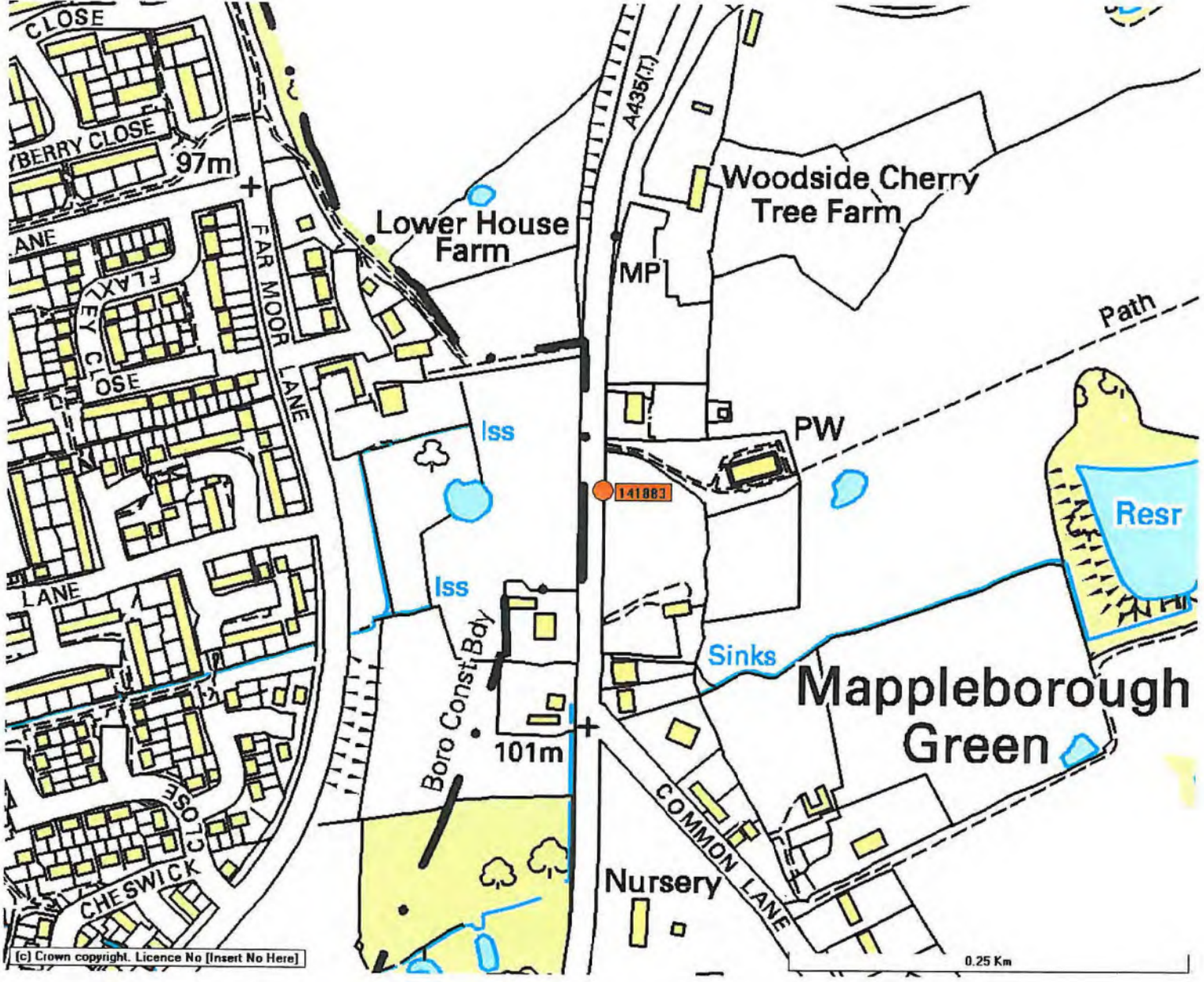

[c] Crown copyright. Licence No [Insert No Here]

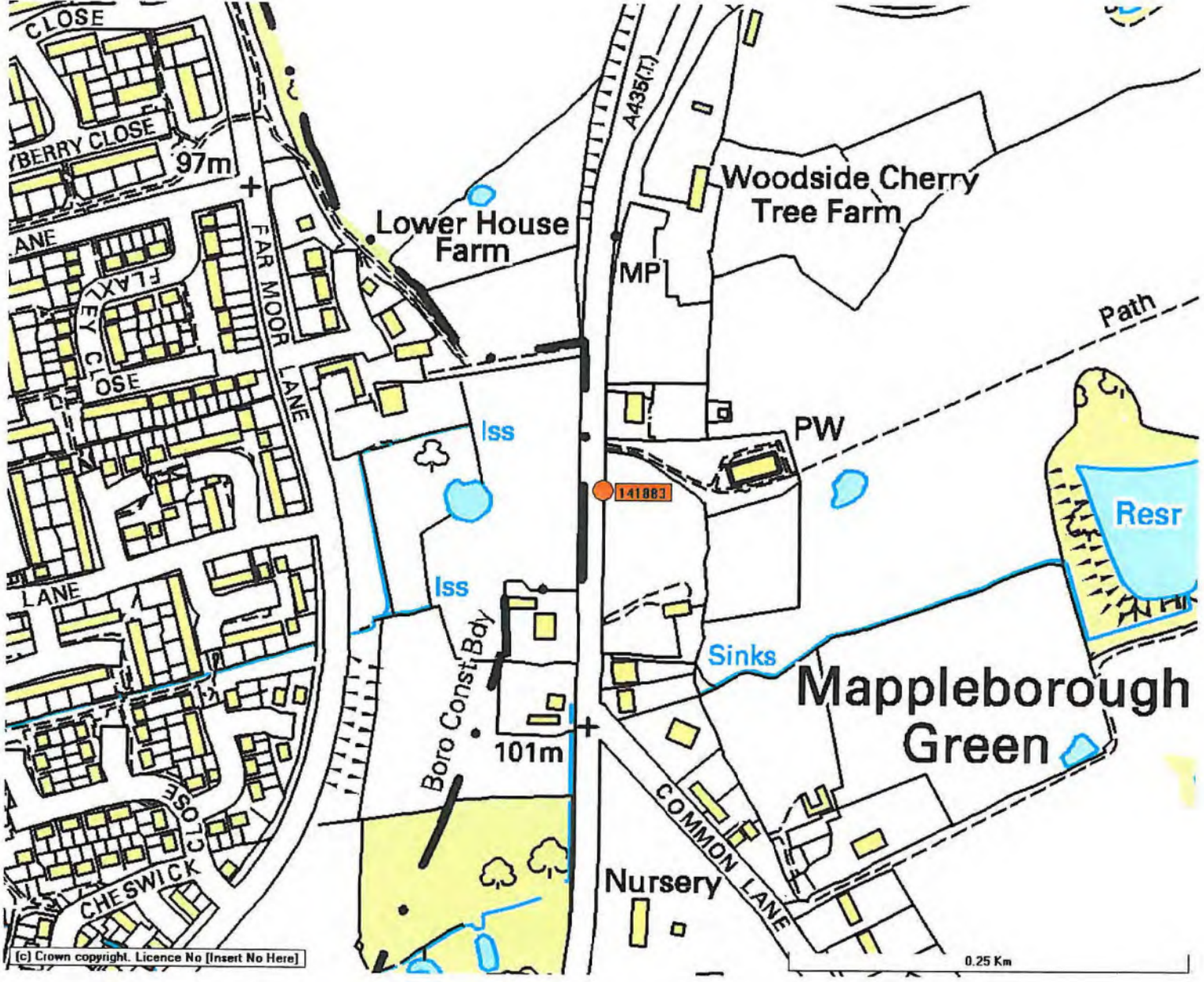

[c] Crown copyright. Licence No [Insert No Here]

| Speed | No. Veh | | Speed | No. Veh | | | |
|-------|---------|-----|-------|---------|------|-------|--------|
| 10 | | 0 | 46 | 8 | 368 | 0 | 16928 |
| 11 | | 0 | 47 | 5 | 235 | 0 | 11045 |
| 12 | | 0 | 48 | 7 | 336 | 0 | 16128 |
| 13 | | 0 | 49 | 2 | 98 | 0 | 4802 |
| 14 | | 0 | 50 | 3 | 150 | 0 | 7500 |
| 15 | | 0 | 51 | 7 | 357 | 0 | 18207 |
| 16 | | 0 | 52 | 4 | 208 | 0 | 10816 |
| 17 | | 0 | 53 | 4 | 212 | 0 | 11236 |
| 18 | | 0 | 54 | 6 | 324 | 0 | 17496 |
| 19 | | 0 | 55 | 4 | 220 | 0 | 12100 |
| 20 | | 0 | 56 | 2 | 112 | 0 | 6272 |
| 21 | | 0 | 57 | 6 | 342 | 0 | 19494 |
| 22 | | 0 | 58 | 3 | 174 | 0 | 10092 |
| 23 | | 0 | 59 | 5 | 295 | 0 | 17405 |
| 24 | | 0 | 60 | 8 | 480 | 0 | 28800 |
| 25 | | 0 | 61 | 2 | 122 | 0 | 7442 |
| 26 | | 0 | 62 | 4 | 248 | 0 | 15376 |
| 27 | | 0 | 63 | 1 | 63 | 0 | 3969 |
| 28 | | 0 | 64 | 1 | 64 | 0 | 4096 |
| 29 | | 0 | 65 | 1 | 65 | 0 | 4225 |
| 30 | | 0 | 66 | 1 | 66 | 0 | 4356 |
| 31 | | 0 | 67 | 1 | 67 | 0 | 4489 |
| 32 | | 0 | 68 | 2 | 136 | 0 | 9248 |
| 33 | | 0 | 69 | 3 | 207 | 0 | 14283 |
| 34 | | 0 | 70 | | 0 | 0 | 0 |
| 35 | | 0 | 71 | | 0 | 0 | 0 |
| 36 | | 0 | 72 | 2 | 144 | 0 | 10368 |
| 37 | | 0 | 73 | | 0 | 0 | 0 |
| 38 | | 0 | 74 | 1 | 74 | 0 | 5476 |
| 39 | | 0 | 75 | 1 | 75 | 0 | 5625 |
| 40 | | 0 | 76 | | 0 | 0 | 0 |
| 41 | 1 | 41 | 77 | | 0 | 1681 | 0 |
| 42 | 1 | 42 | 78 | | 0 | 1764 | 0 |
| 43 | 2 | 86 | 79 | | 0 | 3698 | 0 |
| 44 | 4 | 176 | 80 | 1 | 80 | 7744 | 6400 |
| 45 | 1 | 45 | 81 | | 0 | 2025 | 0 |
| | 9 | 390 | | 95 | 5322 | 16912 | 303674 |

| No.Records | SUM SPEEDS | SUM SPEEDS SQR |
|---|------------|----------------|
| 104 | 5712 | 320586 |
| mph or kph? | | mph |
| if mph enter 4.97 for Dual C'way and 2.49 for Single C'way, otherwise 0 | | 4.97 |
| if kph enter 8 for Dual C'way and 4 for Single C'way, otherwise 0 | | 0 |

ENTER DATA IN YELLOW BOXES ONLY

Form No: 19
Issue No: 00

| | | |
|--------------------|---|----------|
| Mean (m) | = | 54.92308 |
| Standard Deviation | = | 8.164204 |
| 85%ile speed | = | 63.08728 |

85th Percentile Speed

| | |
|--------------------------|-------------------------------------|
| Location of speed survey | A4023 Coventry Highway east of A435 |
| Direction of travel | Westbound |
| Time | 11:55 AM |
| Weather | Dry & Windy |

| | |
|-----------------------------------|-------------------------|
| Number of speed measurements | 104 |
| Mean of traffic speeds | 54.92 |
| Standard Deviation | 8.16 |
| 85th percentile speed | <u>63.09 mph</u> |
| Wet weather 85th percentile speed | <u>58.12 mph</u> |



| |
|-----------------------------|
| Form No: 17 Issue No: 00 |
|-----------------------------|

APPENDIX E

Sustainable Transport Information

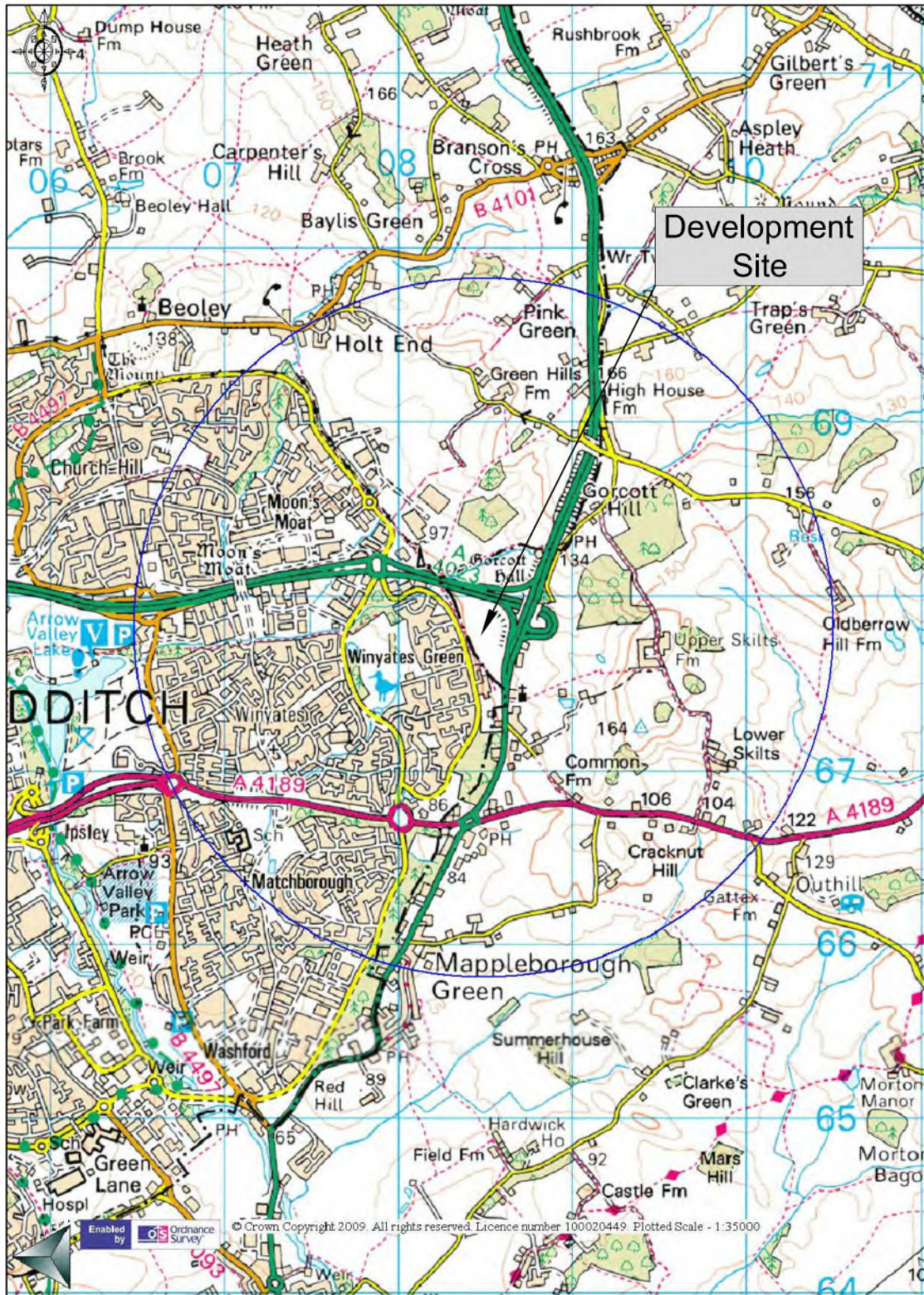

Reproduced by permission of Ordnance Survey on behalf of HMSO © Crown Copyright 2006. All rights reserved. Ordnance Survey Licence number 100046211

DO NOT SCALE. USE FIGURED DIMENSIONS ONLY. CHECK ON SITE AND REPORT ANY DISCREPANCIES TO MORGAN TUCKER.

| Rev | Amendment | Date |
|-----|-----------|------|
| | | |

| | | | |
|---|-------------------------------|------------------|-------------------|
| Client Redditch Borough Council | Drawn By CR | Checked By LB | Approved By BS |
| Project Title Proposed Diversification Park Development | Date 24/09/09 | Scale NTS | |
| Drawing Title 2KM Walking Isochrone | Purpose Information | | Rev |
| Drawing Number JN835 - NWK - 003 | | | |
| Copyright © Morgan Tucker | | | |

AURA Commerce and Technology Centre, Manners Road
Newark, Nottinghamshire, NG24 1BS
Tel:- 01636 610 766 Fax:- 01636 610 786
E-Mail:- info@morgantucker.co.uk
www.morgantucker.co.uk

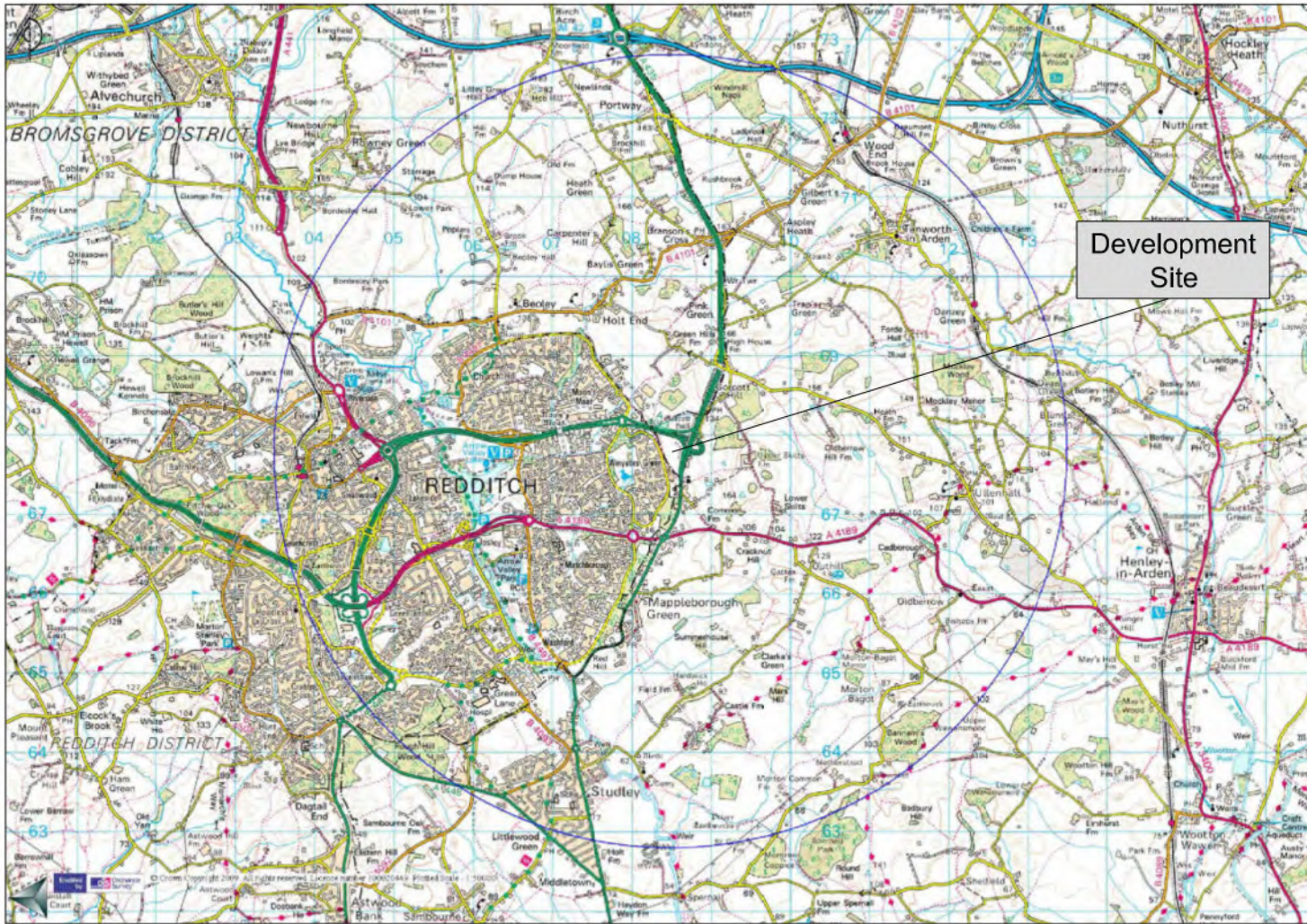

Reproduced by permission of Ordnance Survey on behalf of HMSO © Crown Copyright 2006. All rights reserved. Ordnance Survey Licence number 100046211

Copyright © Morgan Tucker

DO NOT SCALE. USE FIGURED DIMENSIONS ONLY. CHECK ON SITE AND REPORT ALL DISCREPANCIES TO MORGAN TUCKER.

| Rev | Amendment | Date |
|-----|-----------|------|
| | | |



AURA Commerce and Technology Centre, Manners Road, Newark Nottinghamshire, NG24 1BS
 Tel:- 01636 610 766 Fax:- 01636 610 786
 E-Mail:- info@morgantucker.co.uk
 www.morgantucker.co.uk

Client
 Redditch Borough Council

Project Title
 Proposed Diversification Park Development

Drawing Title
 5KM Cycling Isochrone

Drawn By CR Checked By LB Approved By BS

Date 24/09/09 Scale NTS

Purpose Information

Drawing Number
JN835 - NWK - 004



| | |
|------------|---|
| Key | |
| Bus Stop | ● |

| | | | | | | |
|---|--|---|------------------------|--|-----------|------|
| Reproduced by permission of Ordnance Survey on behalf of HMSO © Crown Copyright 2006. All rights reserved. Ordnance Survey Licence number 100046211 | | DO NOT SCALE. USE FIGURED DIMENSIONS ONLY. CHECK ON SITE AND REPORT ANY DISCREPANCIES TO MORGAN TUCKER. | | Rev | Amendment | Date |
| Client Redditch Borough Council | Drawn By CR | Checked By LB | Approved By BS |  <p>AURA Commerce and Technology Centre, Manners Road Newark, Nottinghamshire, NG24 1BS Tel:- 01636 610 766 Fax:- 01636 610 786 E-Mail:- info@morgantucker.co.uk www.morgantucker.co.uk</p> | | |
| Project Title Proposed Diversification Park Development | Date 24/09/09 | Scale NTS | Purpose Information | | | |
| Drawing Title 400m Public Transport Isochrone | Drawing Number JN835 - NWK - 005 | | Rev | | | |
| Copyright © Morgan Tucker | | | | | | |

APPENDIX F

Multimodal Transport Survey
TRICS Outputs
Development Trip Assignment Diagrams

Location: Entrance to the Newark Beacon business innovation centre on Cafferata Way
 Date of Survey: 4th September 2009

| Time | | Inbound | | | | | | | | Outbound | | | | | | | |
|-------|-------|---------|-------------|-------------|---------------|----------|-----|------------|-------|----------|-------------|-------------|---------------|----------|-----|------------|-------|
| From | To | Pedal | Motor cycle | Cars / Taxi | Bus and Coach | LGV/ Van | HGV | Pedestrian | TOTAL | Pedal | Motor cycle | Cars / Taxi | Bus and Coach | LGV/ Van | HGV | Pedestrian | TOTAL |
| 8:00 | 8:30 | 1 | | 12 | | 1 | | 3 | 17 | | | 1 | | | | | 1 |
| 8:30 | 9:00 | 2 | | 29 | | | | 7 | 38 | | | 3 | | | | 1 | 4 |
| | | 3 | 0 | 41 | 0 | 1 | 0 | 10 | 55 | 0 | 0 | 4 | 0 | 0 | 0 | 1 | 5 |
| 9:00 | 9:30 | | | 13 | | | | | 13 | | | 3 | | 4 | | | 7 |
| 9:30 | 10:00 | | | 8 | | 2 | | 2 | 12 | | | 1 | | | | | 1 |
| | | 0 | 0 | 21 | 0 | 2 | 0 | 2 | 25 | 0 | 0 | 4 | 0 | 4 | 0 | 0 | 8 |
| 10:00 | 10:30 | | | 4 | | 1 | | | 5 | | | 2 | | | | | 2 |
| 10:30 | 11:00 | | | 1 | | 1 | | | 2 | 1 | | 1 | | | | 1 | 3 |
| | | 0 | 0 | 5 | 0 | 2 | 0 | 0 | 7 | 1 | 0 | 3 | 0 | 0 | 0 | 1 | 5 |
| 11:00 | 11:30 | | | 2 | | 1 | | 1 | 4 | | | 1 | | 2 | | 2 | 5 |
| 11:30 | 12:00 | | | 9 | | 1 | | | 10 | | | 1 | | | | 1 | 2 |
| | | 0 | 0 | 11 | 0 | 2 | 0 | 1 | 14 | 0 | 0 | 2 | 0 | 2 | 0 | 3 | 7 |
| 12:00 | 12:30 | | | 7 | | | | | 7 | | | 7 | | 1 | | 1 | 9 |
| 12:30 | 13:00 | | | 11 | | | | 4 | 15 | | | 8 | | | | 2 | 10 |
| | | 0 | 0 | 18 | 0 | 0 | 0 | 4 | 22 | 0 | 0 | 15 | 0 | 1 | 0 | 3 | 19 |
| 13:00 | 13:30 | | | 3 | | | | 2 | 5 | | | 6 | | | | 3 | 9 |
| 13:30 | 14:00 | | | 10 | | | | 1 | 11 | | | 4 | | | | 1 | 5 |
| | | 0 | 0 | 13 | 0 | 0 | 0 | 3 | 16 | 0 | 0 | 10 | 0 | 0 | 0 | 4 | 14 |
| 14:00 | 14:30 | | | 5 | | | | | 5 | 1 | | 5 | | | | | 6 |
| 14:30 | 15:00 | | | | | | | | 0 | | | 1 | | | | | 1 |
| | | 0 | 0 | 5 | 0 | 0 | 0 | 0 | 5 | 1 | 0 | 6 | 0 | 0 | 0 | 0 | 7 |
| 15:00 | 15:30 | | | 1 | | | | | 1 | | | 4 | | | | | 4 |
| 15:30 | 16:00 | | | 2 | | | | | 2 | | | 12 | | 1 | | | 13 |
| | | 0 | 0 | 3 | 0 | 0 | 0 | 0 | 3 | 0 | 0 | 16 | 0 | 1 | 0 | 0 | 17 |
| 16:00 | 16:30 | | | 2 | | | | 1 | 3 | | | 13 | | | | 1 | 14 |
| 16:30 | 17:00 | 1 | | 3 | | | | | 4 | 1 | | 12 | | | | | 13 |
| | | 1 | 0 | 5 | 0 | 0 | 0 | 1 | 7 | 1 | 0 | 25 | 0 | 0 | 0 | 1 | 27 |
| 17:00 | 17:30 | 1 | | 2 | | | | | 3 | 1 | | 24 | | 1 | | 1 | 27 |
| 17:30 | 18:00 | | | 3 | | | | | 3 | | | 8 | | | | | 8 |
| | | 1 | 0 | 5 | 0 | 0 | 0 | 0 | 6 | 1 | 0 | 32 | 0 | 1 | 0 | 1 | 35 |
| | | 5 | 0 | 127 | 0 | 7 | 0 | 21 | 160 | 4 | 0 | 117 | 0 | 9 | 0 | 14 | 144 |

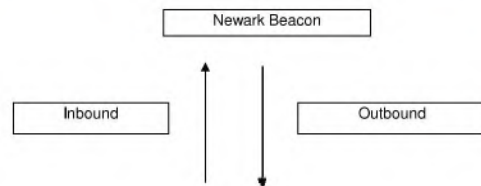

TRIP RATE CALCULATION SELECTION PARAMETERS:

Land Use : 02 - EMPLOYMENT
 Category : B - BUSINESS PARK

MULTI-MODAL CYCLISTS

Selected regions and areas:

| | | |
|--|--------------------|--------|
| 02 SOUTH EAST | | |
| BU | BUCKINGHAMSHIRE | 1 days |
| 03 SOUTH WEST | | |
| DC | DORSET | 1 days |
| WL | WILTSHIRE | 1 days |
| 04 EAST ANGLIA | | |
| SF | SUFFOLK | 1 days |
| 05 EAST MIDLANDS | | |
| LN | LINCOLNSHIRE | 1 days |
| NT | NOTTINGHAMSHIRE | 1 days |
| 06 WEST MIDLANDS | | |
| SH | SHROPSHIRE | 1 days |
| ST | STAFFORDSHIRE | 1 days |
| WO | WORCESTERSHIRE | 1 days |
| 07 YORKSHIRE & NORTH LINCOLNSHIRE | | |
| NO | NORTH LINCOLNSHIRE | 1 days |
| 09 NORTH | | |
| TW | TYNE & WEAR | 1 days |

Filtering Stage 2 selection:

Parameter: Gross floor area
 Range: 975 to 27142 (units: sqm)

Public Transport Provision:

Selection by: Include all surveys

Date Range: 01/01/00 to 10/10/08

Selected survey days:

| | |
|-----------|--------|
| Monday | 1 days |
| Tuesday | 3 days |
| Wednesday | 1 days |
| Thursday | 5 days |
| Friday | 1 days |

Selected survey types:

| | |
|-----------------------|---------|
| Manual count | 11 days |
| Directional ATC Count | 0 days |

Selected Locations:

| | |
|------------------------------------|---|
| Suburban Area (PPS6 Out of Centre) | 3 |
| Edge of Town | 8 |

Selected Location Sub Categories:

| | |
|------------------|---|
| Industrial Zone | 5 |
| Commercial Zone | 1 |
| Residential Zone | 2 |
| Built-Up Zone | 1 |
| No Sub Category | 2 |

TRIP RATE for Land Use 02 - EMPLOYMENT/B - BUSINESS PARK

MULTI-MODAL CYCLISTS

Calculation factor: 100 sqm

Estimated TRIP rate value per 10000 SQM shown in shaded columns

BOLD print indicates peak (busiest) period

| Time Range | ARRIVALS | | | | DEPARTURES | | | | TOTALS | | | |
|---------------------|-----------|-------------|--------------|---------------------|------------|-------------|--------------|---------------------|-----------|-------------|--------------|---------------------|
| | No. Days | Ave. GFA | Trip Rate | Estimated Trip Rate | No. Days | Ave. GFA | Trip Rate | Estimated Trip Rate | No. Days | Ave. GFA | Trip Rate | Estimated Trip Rate |
| 00:00 - 00:30 | 0 | 0 | 0.000 | 0.000 | 0 | 0 | 0.000 | 0.000 | 0 | 0 | 0.000 | 0.000 |
| 00:30 - 01:00 | 0 | 0 | 0.000 | 0.000 | 0 | 0 | 0.000 | 0.000 | 0 | 0 | 0.000 | 0.000 |
| 01:00 - 01:30 | 0 | 0 | 0.000 | 0.000 | 0 | 0 | 0.000 | 0.000 | 0 | 0 | 0.000 | 0.000 |
| 01:30 - 02:00 | 0 | 0 | 0.000 | 0.000 | 0 | 0 | 0.000 | 0.000 | 0 | 0 | 0.000 | 0.000 |
| 02:00 - 02:30 | 0 | 0 | 0.000 | 0.000 | 0 | 0 | 0.000 | 0.000 | 0 | 0 | 0.000 | 0.000 |
| 02:30 - 03:00 | 0 | 0 | 0.000 | 0.000 | 0 | 0 | 0.000 | 0.000 | 0 | 0 | 0.000 | 0.000 |
| 03:00 - 03:30 | 0 | 0 | 0.000 | 0.000 | 0 | 0 | 0.000 | 0.000 | 0 | 0 | 0.000 | 0.000 |
| 03:30 - 04:00 | 0 | 0 | 0.000 | 0.000 | 0 | 0 | 0.000 | 0.000 | 0 | 0 | 0.000 | 0.000 |
| 04:00 - 04:30 | 0 | 0 | 0.000 | 0.000 | 0 | 0 | 0.000 | 0.000 | 0 | 0 | 0.000 | 0.000 |
| 04:30 - 05:00 | 0 | 0 | 0.000 | 0.000 | 0 | 0 | 0.000 | 0.000 | 0 | 0 | 0.000 | 0.000 |
| 05:00 - 05:30 | 0 | 0 | 0.000 | 0.000 | 0 | 0 | 0.000 | 0.000 | 0 | 0 | 0.000 | 0.000 |
| 05:30 - 06:00 | 0 | 0 | 0.000 | 0.000 | 0 | 0 | 0.000 | 0.000 | 0 | 0 | 0.000 | 0.000 |
| 06:00 - 06:30 | 0 | 0 | 0.000 | 0.000 | 0 | 0 | 0.000 | 0.000 | 0 | 0 | 0.000 | 0.000 |
| 06:30 - 07:00 | 0 | 0 | 0.000 | 0.000 | 0 | 0 | 0.000 | 0.000 | 0 | 0 | 0.000 | 0.000 |
| 07:00 - 07:30 | 11 | 7294 | 0.005 | 0.499 | 11 | 7294 | 0.001 | 0.125 | 11 | 7294 | 0.006 | 0.624 |
| 07:30 - 08:00 | 11 | 7294 | 0.004 | 0.374 | 11 | 7294 | 0.002 | 0.249 | 11 | 7294 | 0.006 | 0.623 |
| 08:00 - 08:30 | 11 | 7294 | 0.015 | 1.496 | 11 | 7294 | 0.001 | 0.125 | 11 | 7294 | 0.016 | 1.621 |
| 08:30 - 09:00 | 11 | 7294 | 0.010 | 0.997 | 11 | 7294 | 0.000 | 0.000 | 11 | 7294 | 0.010 | 0.997 |
| 09:00 - 09:30 | 11 | 7294 | 0.009 | 0.872 | 11 | 7294 | 0.001 | 0.125 | 11 | 7294 | 0.010 | 0.997 |
| 09:30 - 10:00 | 11 | 7294 | 0.005 | 0.499 | 11 | 7294 | 0.000 | 0.000 | 11 | 7294 | 0.005 | 0.499 |
| 10:00 - 10:30 | 11 | 7294 | 0.001 | 0.125 | 11 | 7294 | 0.001 | 0.125 | 11 | 7294 | 0.002 | 0.250 |
| 10:30 - 11:00 | 11 | 7294 | 0.002 | 0.249 | 11 | 7294 | 0.001 | 0.125 | 11 | 7294 | 0.003 | 0.374 |
| 11:00 - 11:30 | 11 | 7294 | 0.002 | 0.249 | 11 | 7294 | 0.002 | 0.249 | 11 | 7294 | 0.004 | 0.498 |
| 11:30 - 12:00 | 11 | 7294 | 0.002 | 0.249 | 11 | 7294 | 0.001 | 0.125 | 11 | 7294 | 0.003 | 0.374 |
| 12:00 - 12:30 | 11 | 7294 | 0.001 | 0.125 | 11 | 7294 | 0.005 | 0.499 | 11 | 7294 | 0.006 | 0.624 |
| 12:30 - 13:00 | 11 | 7294 | 0.002 | 0.249 | 11 | 7294 | 0.001 | 0.125 | 11 | 7294 | 0.003 | 0.374 |
| 13:00 - 13:30 | 11 | 7294 | 0.002 | 0.249 | 11 | 7294 | 0.004 | 0.374 | 11 | 7294 | 0.006 | 0.623 |
| 13:30 - 14:00 | 11 | 7294 | 0.002 | 0.249 | 11 | 7294 | 0.005 | 0.499 | 11 | 7294 | 0.007 | 0.748 |
| 14:00 - 14:30 | 11 | 7294 | 0.000 | 0.000 | 11 | 7294 | 0.001 | 0.125 | 11 | 7294 | 0.001 | 0.125 |
| 14:30 - 15:00 | 11 | 7294 | 0.000 | 0.000 | 11 | 7294 | 0.004 | 0.374 | 11 | 7294 | 0.004 | 0.374 |
| 15:00 - 15:30 | 11 | 7294 | 0.000 | 0.000 | 11 | 7294 | 0.000 | 0.000 | 11 | 7294 | 0.000 | 0.000 |
| 15:30 - 16:00 | 11 | 7294 | 0.000 | 0.000 | 11 | 7294 | 0.004 | 0.374 | 11 | 7294 | 0.004 | 0.374 |
| 16:00 - 16:30 | 11 | 7294 | 0.001 | 0.125 | 11 | 7294 | 0.010 | 0.997 | 11 | 7294 | 0.011 | 1.122 |
| 16:30 - 17:00 | 11 | 7294 | 0.002 | 0.249 | 11 | 7294 | 0.005 | 0.499 | 11 | 7294 | 0.007 | 0.748 |
| 17:00 - 17:30 | 11 | 7294 | 0.000 | 0.000 | 11 | 7294 | 0.006 | 0.623 | 11 | 7294 | 0.006 | 0.623 |
| 17:30 - 18:00 | 11 | 7294 | 0.000 | 0.000 | 11 | 7294 | 0.009 | 0.872 | 11 | 7294 | 0.009 | 0.872 |
| 18:00 - 18:30 | 11 | 7294 | 0.000 | 0.000 | 11 | 7294 | 0.002 | 0.249 | 11 | 7294 | 0.002 | 0.249 |
| 18:30 - 19:00 | 11 | 7294 | 0.000 | 0.000 | 11 | 7294 | 0.000 | 0.000 | 11 | 7294 | 0.000 | 0.000 |
| 19:00 - 19:30 | 0 | 0 | 0.000 | 0.000 | 0 | 0 | 0.000 | 0.000 | 0 | 0 | 0.000 | 0.000 |
| 19:30 - 20:00 | 0 | 0 | 0.000 | 0.000 | 0 | 0 | 0.000 | 0.000 | 0 | 0 | 0.000 | 0.000 |
| 20:00 - 20:30 | 0 | 0 | 0.000 | 0.000 | 0 | 0 | 0.000 | 0.000 | 0 | 0 | 0.000 | 0.000 |
| 20:30 - 21:00 | 0 | 0 | 0.000 | 0.000 | 0 | 0 | 0.000 | 0.000 | 0 | 0 | 0.000 | 0.000 |
| 21:00 - 21:30 | 0 | 0 | 0.000 | 0.000 | 0 | 0 | 0.000 | 0.000 | 0 | 0 | 0.000 | 0.000 |
| 21:30 - 22:00 | 0 | 0 | 0.000 | 0.000 | 0 | 0 | 0.000 | 0.000 | 0 | 0 | 0.000 | 0.000 |
| 22:00 - 22:30 | 0 | 0 | 0.000 | 0.000 | 0 | 0 | 0.000 | 0.000 | 0 | 0 | 0.000 | 0.000 |
| 22:30 - 23:00 | 0 | 0 | 0.000 | 0.000 | 0 | 0 | 0.000 | 0.000 | 0 | 0 | 0.000 | 0.000 |
| 23:00 - 23:30 | 0 | 0 | 0.000 | 0.000 | 0 | 0 | 0.000 | 0.000 | 0 | 0 | 0.000 | 0.000 |
| 23:30 - 24:00 | 0 | 0 | 0.000 | 0.000 | 0 | 0 | 0.000 | 0.000 | 0 | 0 | 0.000 | 0.000 |
| Total Rates: | | | 0.065 | 6.855 | | | 0.066 | 6.858 | | | 0.131 | 13.713 |

Parameter summary

| | |
|--|--------------------------|
| Trip rate parameter range selected: | 975 - 27142 (units: sqm) |
| Survey date date range: | 01/01/00 - 10/10/08 |
| Number of weekdays (Monday-Friday): | 11 |
| Number of Saturdays: | 0 |
| Number of Sundays: | 0 |
| Surveys manually removed from selection: | 0 |

TRIP RATE CALCULATION SELECTION PARAMETERS:

Land Use : 02 - EMPLOYMENT
 Category : B - BUSINESS PARK

MULTI-MODAL PEDESTRIANS

Selected regions and areas:

| | | |
|--|--------------------|--------|
| 02 SOUTH EAST | | |
| BU | BUCKINGHAMSHIRE | 1 days |
| 03 SOUTH WEST | | |
| DC | DORSET | 1 days |
| WL | WILTSHIRE | 1 days |
| 04 EAST ANGLIA | | |
| SF | SUFFOLK | 1 days |
| 05 EAST MIDLANDS | | |
| LN | LINCOLNSHIRE | 1 days |
| NT | NOTTINGHAMSHIRE | 1 days |
| 06 WEST MIDLANDS | | |
| SH | SHROPSHIRE | 1 days |
| ST | STAFFORDSHIRE | 1 days |
| WO | WORCESTERSHIRE | 1 days |
| 07 YORKSHIRE & NORTH LINCOLNSHIRE | | |
| NO | NORTH LINCOLNSHIRE | 1 days |
| 09 NORTH | | |
| TW | TYNE & WEAR | 1 days |

Filtering Stage 2 selection:

Parameter: Gross floor area
 Range: 975 to 27142 (units: sqm)

Public Transport Provision:

Selection by: Include all surveys

Date Range: 01/01/00 to 10/10/08

Selected survey days:

| | |
|-----------|--------|
| Monday | 1 days |
| Tuesday | 3 days |
| Wednesday | 1 days |
| Thursday | 5 days |
| Friday | 1 days |

Selected survey types:

| | |
|-----------------------|---------|
| Manual count | 11 days |
| Directional ATC Count | 0 days |

Selected Locations:

| | |
|------------------------------------|---|
| Suburban Area (PPS6 Out of Centre) | 3 |
| Edge of Town | 8 |

Selected Location Sub Categories:

| | |
|------------------|---|
| Industrial Zone | 5 |
| Commercial Zone | 1 |
| Residential Zone | 2 |
| Built-Up Zone | 1 |
| No Sub Category | 2 |

TRIP RATE for Land Use 02 - EMPLOYMENT/B - BUSINESS PARK

MULTI-MODAL PEDESTRIANS

Calculation factor: 100 sqm

Estimated TRIP rate value per 10000 SQM shown in shaded columns

BOLD print indicates peak (busiest) period

| Time Range | ARRIVALS | | | | DEPARTURES | | | | TOTALS | | | |
|---------------------|-----------|-------------|--------------|---------------------|------------|-------------|--------------|---------------------|-----------|-------------|--------------|---------------------|
| | No. Days | Ave. GFA | Trip Rate | Estimated Trip Rate | No. Days | Ave. GFA | Trip Rate | Estimated Trip Rate | No. Days | Ave. GFA | Trip Rate | Estimated Trip Rate |
| 00:00 - 00:30 | 0 | 0 | 0.000 | 0.000 | 0 | 0 | 0.000 | 0.000 | 0 | 0 | 0.000 | 0.000 |
| 00:30 - 01:00 | 0 | 0 | 0.000 | 0.000 | 0 | 0 | 0.000 | 0.000 | 0 | 0 | 0.000 | 0.000 |
| 01:00 - 01:30 | 0 | 0 | 0.000 | 0.000 | 0 | 0 | 0.000 | 0.000 | 0 | 0 | 0.000 | 0.000 |
| 01:30 - 02:00 | 0 | 0 | 0.000 | 0.000 | 0 | 0 | 0.000 | 0.000 | 0 | 0 | 0.000 | 0.000 |
| 02:00 - 02:30 | 0 | 0 | 0.000 | 0.000 | 0 | 0 | 0.000 | 0.000 | 0 | 0 | 0.000 | 0.000 |
| 02:30 - 03:00 | 0 | 0 | 0.000 | 0.000 | 0 | 0 | 0.000 | 0.000 | 0 | 0 | 0.000 | 0.000 |
| 03:00 - 03:30 | 0 | 0 | 0.000 | 0.000 | 0 | 0 | 0.000 | 0.000 | 0 | 0 | 0.000 | 0.000 |
| 03:30 - 04:00 | 0 | 0 | 0.000 | 0.000 | 0 | 0 | 0.000 | 0.000 | 0 | 0 | 0.000 | 0.000 |
| 04:00 - 04:30 | 0 | 0 | 0.000 | 0.000 | 0 | 0 | 0.000 | 0.000 | 0 | 0 | 0.000 | 0.000 |
| 04:30 - 05:00 | 0 | 0 | 0.000 | 0.000 | 0 | 0 | 0.000 | 0.000 | 0 | 0 | 0.000 | 0.000 |
| 05:00 - 05:30 | 0 | 0 | 0.000 | 0.000 | 0 | 0 | 0.000 | 0.000 | 0 | 0 | 0.000 | 0.000 |
| 05:30 - 06:00 | 0 | 0 | 0.000 | 0.000 | 0 | 0 | 0.000 | 0.000 | 0 | 0 | 0.000 | 0.000 |
| 06:00 - 06:30 | 0 | 0 | 0.000 | 0.000 | 0 | 0 | 0.000 | 0.000 | 0 | 0 | 0.000 | 0.000 |
| 06:30 - 07:00 | 0 | 0 | 0.000 | 0.000 | 0 | 0 | 0.000 | 0.000 | 0 | 0 | 0.000 | 0.000 |
| 07:00 - 07:30 | 11 | 7294 | 0.004 | 0.374 | 11 | 7294 | 0.000 | 0.000 | 11 | 7294 | 0.004 | 0.374 |
| 07:30 - 08:00 | 11 | 7294 | 0.010 | 0.997 | 11 | 7294 | 0.004 | 0.374 | 11 | 7294 | 0.014 | 1.371 |
| 08:00 - 08:30 | 11 | 7294 | 0.042 | 4.238 | 11 | 7294 | 0.005 | 0.499 | 11 | 7294 | 0.047 | 4.737 |
| 08:30 - 09:00 | 11 | 7294 | 0.062 | 6.232 | 11 | 7294 | 0.001 | 0.125 | 11 | 7294 | 0.063 | 6.357 |
| 09:00 - 09:30 | 11 | 7294 | 0.012 | 1.246 | 11 | 7294 | 0.000 | 0.000 | 11 | 7294 | 0.012 | 1.246 |
| 09:30 - 10:00 | 11 | 7294 | 0.022 | 2.243 | 11 | 7294 | 0.012 | 1.246 | 11 | 7294 | 0.034 | 3.489 |
| 10:00 - 10:30 | 11 | 7294 | 0.022 | 2.243 | 11 | 7294 | 0.012 | 1.246 | 11 | 7294 | 0.034 | 3.489 |
| 10:30 - 11:00 | 11 | 7294 | 0.011 | 1.122 | 11 | 7294 | 0.006 | 0.623 | 11 | 7294 | 0.017 | 1.745 |
| 11:00 - 11:30 | 11 | 7294 | 0.006 | 0.623 | 11 | 7294 | 0.001 | 0.125 | 11 | 7294 | 0.007 | 0.748 |
| 11:30 - 12:00 | 11 | 7294 | 0.012 | 1.246 | 11 | 7294 | 0.024 | 2.368 | 11 | 7294 | 0.036 | 3.614 |
| 12:00 - 12:30 | 11 | 7294 | 0.035 | 3.490 | 11 | 7294 | 0.022 | 2.243 | 11 | 7294 | 0.057 | 5.733 |
| 12:30 - 13:00 | 11 | 7294 | 0.035 | 3.490 | 11 | 7294 | 0.035 | 3.490 | 11 | 7294 | 0.070 | 6.980 |
| 13:00 - 13:30 | 11 | 7294 | 0.040 | 3.988 | 11 | 7294 | 0.055 | 5.484 | 11 | 7294 | 0.095 | 9.472 |
| 13:30 - 14:00 | 11 | 7294 | 0.042 | 4.238 | 11 | 7294 | 0.034 | 3.365 | 11 | 7294 | 0.076 | 7.603 |
| 14:00 - 14:30 | 11 | 7294 | 0.016 | 1.620 | 11 | 7294 | 0.014 | 1.371 | 11 | 7294 | 0.030 | 2.991 |
| 14:30 - 15:00 | 11 | 7294 | 0.017 | 1.745 | 11 | 7294 | 0.007 | 0.748 | 11 | 7294 | 0.024 | 2.493 |
| 15:00 - 15:30 | 11 | 7294 | 0.004 | 0.374 | 11 | 7294 | 0.005 | 0.499 | 11 | 7294 | 0.009 | 0.873 |
| 15:30 - 16:00 | 11 | 7294 | 0.009 | 0.872 | 11 | 7294 | 0.010 | 0.997 | 11 | 7294 | 0.019 | 1.869 |
| 16:00 - 16:30 | 11 | 7294 | 0.004 | 0.374 | 11 | 7294 | 0.015 | 1.496 | 11 | 7294 | 0.019 | 1.870 |
| 16:30 - 17:00 | 11 | 7294 | 0.006 | 0.623 | 11 | 7294 | 0.020 | 1.994 | 11 | 7294 | 0.026 | 2.617 |
| 17:00 - 17:30 | 11 | 7294 | 0.006 | 0.623 | 11 | 7294 | 0.050 | 4.985 | 11 | 7294 | 0.056 | 5.608 |
| 17:30 - 18:00 | 11 | 7294 | 0.012 | 1.246 | 11 | 7294 | 0.035 | 3.490 | 11 | 7294 | 0.047 | 4.736 |
| 18:00 - 18:30 | 11 | 7294 | 0.002 | 0.249 | 11 | 7294 | 0.011 | 1.122 | 11 | 7294 | 0.013 | 1.371 |
| 18:30 - 19:00 | 11 | 7294 | 0.000 | 0.000 | 11 | 7294 | 0.004 | 0.374 | 11 | 7294 | 0.004 | 0.374 |
| 19:00 - 19:30 | 0 | 0 | 0.000 | 0.000 | 0 | 0 | 0.000 | 0.000 | 0 | 0 | 0.000 | 0.000 |
| 19:30 - 20:00 | 0 | 0 | 0.000 | 0.000 | 0 | 0 | 0.000 | 0.000 | 0 | 0 | 0.000 | 0.000 |
| 20:00 - 20:30 | 0 | 0 | 0.000 | 0.000 | 0 | 0 | 0.000 | 0.000 | 0 | 0 | 0.000 | 0.000 |
| 20:30 - 21:00 | 0 | 0 | 0.000 | 0.000 | 0 | 0 | 0.000 | 0.000 | 0 | 0 | 0.000 | 0.000 |
| 21:00 - 21:30 | 0 | 0 | 0.000 | 0.000 | 0 | 0 | 0.000 | 0.000 | 0 | 0 | 0.000 | 0.000 |
| 21:30 - 22:00 | 0 | 0 | 0.000 | 0.000 | 0 | 0 | 0.000 | 0.000 | 0 | 0 | 0.000 | 0.000 |
| 22:00 - 22:30 | 0 | 0 | 0.000 | 0.000 | 0 | 0 | 0.000 | 0.000 | 0 | 0 | 0.000 | 0.000 |
| 22:30 - 23:00 | 0 | 0 | 0.000 | 0.000 | 0 | 0 | 0.000 | 0.000 | 0 | 0 | 0.000 | 0.000 |
| 23:00 - 23:30 | 0 | 0 | 0.000 | 0.000 | 0 | 0 | 0.000 | 0.000 | 0 | 0 | 0.000 | 0.000 |
| 23:30 - 24:00 | 0 | 0 | 0.000 | 0.000 | 0 | 0 | 0.000 | 0.000 | 0 | 0 | 0.000 | 0.000 |
| Total Rates: | | | 0.431 | 43.496 | | | 0.382 | 38.264 | | | 0.813 | 81.760 |

Parameter summary

| | |
|--|--------------------------|
| Trip rate parameter range selected: | 975 - 27142 (units: sqm) |
| Survey date date range: | 01/01/00 - 10/10/08 |
| Number of weekdays (Monday-Friday): | 11 |
| Number of Saturdays: | 0 |
| Number of Sundays: | 0 |
| Surveys manually removed from selection: | 0 |

TRIP RATE CALCULATION SELECTION PARAMETERS:

Land Use : 02 - EMPLOYMENT
 Category : B - BUSINESS PARK

MULTI-MODAL PUBLIC TRANSPORT USERS

Selected regions and areas:

| | | |
|--|--------------------|--------|
| 02 SOUTH EAST | | |
| BU | BUCKINGHAMSHIRE | 1 days |
| 03 SOUTH WEST | | |
| DC | DORSET | 1 days |
| WL | WILTSHIRE | 1 days |
| 04 EAST ANGLIA | | |
| SF | SUFFOLK | 1 days |
| 05 EAST MIDLANDS | | |
| LN | LINCOLNSHIRE | 1 days |
| NT | NOTTINGHAMSHIRE | 1 days |
| 06 WEST MIDLANDS | | |
| SH | SHROPSHIRE | 1 days |
| ST | STAFFORDSHIRE | 1 days |
| WO | WORCESTERSHIRE | 1 days |
| 07 YORKSHIRE & NORTH LINCOLNSHIRE | | |
| NO | NORTH LINCOLNSHIRE | 1 days |
| 09 NORTH | | |
| TW | TYNE & WEAR | 1 days |

Filtering Stage 2 selection:

Parameter: Gross floor area
 Range: 975 to 27142 (units: sqm)

Public Transport Provision:

Selection by: Include all surveys

Date Range: 01/01/00 to 10/10/08

Selected survey days:

| | |
|-----------|--------|
| Monday | 1 days |
| Tuesday | 3 days |
| Wednesday | 1 days |
| Thursday | 5 days |
| Friday | 1 days |

Selected survey types:

| | |
|-----------------------|---------|
| Manual count | 11 days |
| Directional ATC Count | 0 days |

Selected Locations:

| | |
|------------------------------------|---|
| Suburban Area (PPS6 Out of Centre) | 3 |
| Edge of Town | 8 |

Selected Location Sub Categories:

| | |
|------------------|---|
| Industrial Zone | 5 |
| Commercial Zone | 1 |
| Residential Zone | 2 |
| Built-Up Zone | 1 |
| No Sub Category | 2 |

TRIP RATE for Land Use 02 - EMPLOYMENT/B - BUSINESS PARK

MULTI-MODAL PUBLIC TRANSPORT USERS

Calculation factor: 100 sqm

Estimated TRIP rate value per 10000 SQM shown in shaded columns

BOLD print indicates peak (busiest) period

| Time Range | ARRIVALS | | | | DEPARTURES | | | | TOTALS | | | |
|---------------------|-----------|-------------|--------------|---------------------|------------|-------------|--------------|---------------------|-----------|-------------|--------------|---------------------|
| | No. Days | Ave. GFA | Trip Rate | Estimated Trip Rate | No. Days | Ave. GFA | Trip Rate | Estimated Trip Rate | No. Days | Ave. GFA | Trip Rate | Estimated Trip Rate |
| 00:00 - 00:30 | 0 | 0 | 0.000 | 0.000 | 0 | 0 | 0.000 | 0.000 | 0 | 0 | 0.000 | 0.000 |
| 00:30 - 01:00 | 0 | 0 | 0.000 | 0.000 | 0 | 0 | 0.000 | 0.000 | 0 | 0 | 0.000 | 0.000 |
| 01:00 - 01:30 | 0 | 0 | 0.000 | 0.000 | 0 | 0 | 0.000 | 0.000 | 0 | 0 | 0.000 | 0.000 |
| 01:30 - 02:00 | 0 | 0 | 0.000 | 0.000 | 0 | 0 | 0.000 | 0.000 | 0 | 0 | 0.000 | 0.000 |
| 02:00 - 02:30 | 0 | 0 | 0.000 | 0.000 | 0 | 0 | 0.000 | 0.000 | 0 | 0 | 0.000 | 0.000 |
| 02:30 - 03:00 | 0 | 0 | 0.000 | 0.000 | 0 | 0 | 0.000 | 0.000 | 0 | 0 | 0.000 | 0.000 |
| 03:00 - 03:30 | 0 | 0 | 0.000 | 0.000 | 0 | 0 | 0.000 | 0.000 | 0 | 0 | 0.000 | 0.000 |
| 03:30 - 04:00 | 0 | 0 | 0.000 | 0.000 | 0 | 0 | 0.000 | 0.000 | 0 | 0 | 0.000 | 0.000 |
| 04:00 - 04:30 | 0 | 0 | 0.000 | 0.000 | 0 | 0 | 0.000 | 0.000 | 0 | 0 | 0.000 | 0.000 |
| 04:30 - 05:00 | 0 | 0 | 0.000 | 0.000 | 0 | 0 | 0.000 | 0.000 | 0 | 0 | 0.000 | 0.000 |
| 05:00 - 05:30 | 0 | 0 | 0.000 | 0.000 | 0 | 0 | 0.000 | 0.000 | 0 | 0 | 0.000 | 0.000 |
| 05:30 - 06:00 | 0 | 0 | 0.000 | 0.000 | 0 | 0 | 0.000 | 0.000 | 0 | 0 | 0.000 | 0.000 |
| 06:00 - 06:30 | 0 | 0 | 0.000 | 0.000 | 0 | 0 | 0.000 | 0.000 | 0 | 0 | 0.000 | 0.000 |
| 06:30 - 07:00 | 0 | 0 | 0.000 | 0.000 | 0 | 0 | 0.000 | 0.000 | 0 | 0 | 0.000 | 0.000 |
| 07:00 - 07:30 | 11 | 7294 | 0.002 | 0.249 | 11 | 7294 | 0.000 | 0.000 | 11 | 7294 | 0.002 | 0.249 |
| 07:30 - 08:00 | 11 | 7294 | 0.014 | 1.371 | 11 | 7294 | 0.000 | 0.000 | 11 | 7294 | 0.014 | 1.371 |
| 08:00 - 08:30 | 11 | 7294 | 0.016 | 1.620 | 11 | 7294 | 0.001 | 0.125 | 11 | 7294 | 0.017 | 1.745 |
| 08:30 - 09:00 | 11 | 7294 | 0.025 | 2.493 | 11 | 7294 | 0.001 | 0.125 | 11 | 7294 | 0.026 | 2.618 |
| 09:00 - 09:30 | 11 | 7294 | 0.007 | 0.748 | 11 | 7294 | 0.001 | 0.125 | 11 | 7294 | 0.008 | 0.873 |
| 09:30 - 10:00 | 11 | 7294 | 0.004 | 0.374 | 11 | 7294 | 0.001 | 0.125 | 11 | 7294 | 0.005 | 0.499 |
| 10:00 - 10:30 | 11 | 7294 | 0.004 | 0.374 | 11 | 7294 | 0.002 | 0.249 | 11 | 7294 | 0.006 | 0.623 |
| 10:30 - 11:00 | 11 | 7294 | 0.006 | 0.623 | 11 | 7294 | 0.001 | 0.125 | 11 | 7294 | 0.007 | 0.748 |
| 11:00 - 11:30 | 11 | 7294 | 0.002 | 0.249 | 11 | 7294 | 0.005 | 0.499 | 11 | 7294 | 0.007 | 0.748 |
| 11:30 - 12:00 | 11 | 7294 | 0.000 | 0.000 | 11 | 7294 | 0.000 | 0.000 | 11 | 7294 | 0.000 | 0.000 |
| 12:00 - 12:30 | 11 | 7294 | 0.001 | 0.125 | 11 | 7294 | 0.002 | 0.249 | 11 | 7294 | 0.003 | 0.374 |
| 12:30 - 13:00 | 11 | 7294 | 0.001 | 0.125 | 11 | 7294 | 0.005 | 0.499 | 11 | 7294 | 0.006 | 0.624 |
| 13:00 - 13:30 | 11 | 7294 | 0.004 | 0.374 | 11 | 7294 | 0.001 | 0.125 | 11 | 7294 | 0.005 | 0.499 |
| 13:30 - 14:00 | 11 | 7294 | 0.001 | 0.125 | 11 | 7294 | 0.000 | 0.000 | 11 | 7294 | 0.001 | 0.125 |
| 14:00 - 14:30 | 11 | 7294 | 0.000 | 0.000 | 11 | 7294 | 0.002 | 0.249 | 11 | 7294 | 0.002 | 0.249 |
| 14:30 - 15:00 | 11 | 7294 | 0.000 | 0.000 | 11 | 7294 | 0.001 | 0.125 | 11 | 7294 | 0.001 | 0.125 |
| 15:00 - 15:30 | 11 | 7294 | 0.001 | 0.125 | 11 | 7294 | 0.004 | 0.374 | 11 | 7294 | 0.005 | 0.499 |
| 15:30 - 16:00 | 11 | 7294 | 0.000 | 0.000 | 11 | 7294 | 0.001 | 0.125 | 11 | 7294 | 0.001 | 0.125 |
| 16:00 - 16:30 | 11 | 7294 | 0.001 | 0.125 | 11 | 7294 | 0.002 | 0.249 | 11 | 7294 | 0.003 | 0.374 |
| 16:30 - 17:00 | 11 | 7294 | 0.000 | 0.000 | 11 | 7294 | 0.022 | 2.243 | 11 | 7294 | 0.022 | 2.243 |
| 17:00 - 17:30 | 11 | 7294 | 0.000 | 0.000 | 11 | 7294 | 0.010 | 0.997 | 11 | 7294 | 0.010 | 0.997 |
| 17:30 - 18:00 | 11 | 7294 | 0.000 | 0.000 | 11 | 7294 | 0.011 | 1.122 | 11 | 7294 | 0.011 | 1.122 |
| 18:00 - 18:30 | 11 | 7294 | 0.002 | 0.249 | 11 | 7294 | 0.002 | 0.249 | 11 | 7294 | 0.004 | 0.498 |
| 18:30 - 19:00 | 11 | 7294 | 0.000 | 0.000 | 11 | 7294 | 0.000 | 0.000 | 11 | 7294 | 0.000 | 0.000 |
| 19:00 - 19:30 | 0 | 0 | 0.000 | 0.000 | 0 | 0 | 0.000 | 0.000 | 0 | 0 | 0.000 | 0.000 |
| 19:30 - 20:00 | 0 | 0 | 0.000 | 0.000 | 0 | 0 | 0.000 | 0.000 | 0 | 0 | 0.000 | 0.000 |
| 20:00 - 20:30 | 0 | 0 | 0.000 | 0.000 | 0 | 0 | 0.000 | 0.000 | 0 | 0 | 0.000 | 0.000 |
| 20:30 - 21:00 | 0 | 0 | 0.000 | 0.000 | 0 | 0 | 0.000 | 0.000 | 0 | 0 | 0.000 | 0.000 |
| 21:00 - 21:30 | 0 | 0 | 0.000 | 0.000 | 0 | 0 | 0.000 | 0.000 | 0 | 0 | 0.000 | 0.000 |
| 21:30 - 22:00 | 0 | 0 | 0.000 | 0.000 | 0 | 0 | 0.000 | 0.000 | 0 | 0 | 0.000 | 0.000 |
| 22:00 - 22:30 | 0 | 0 | 0.000 | 0.000 | 0 | 0 | 0.000 | 0.000 | 0 | 0 | 0.000 | 0.000 |
| 22:30 - 23:00 | 0 | 0 | 0.000 | 0.000 | 0 | 0 | 0.000 | 0.000 | 0 | 0 | 0.000 | 0.000 |
| 23:00 - 23:30 | 0 | 0 | 0.000 | 0.000 | 0 | 0 | 0.000 | 0.000 | 0 | 0 | 0.000 | 0.000 |
| 23:30 - 24:00 | 0 | 0 | 0.000 | 0.000 | 0 | 0 | 0.000 | 0.000 | 0 | 0 | 0.000 | 0.000 |
| Total Rates: | | | 0.091 | 9.349 | | | 0.075 | 7.979 | | | 0.166 | 17.328 |

Parameter summary

| | |
|--|--------------------------|
| Trip rate parameter range selected: | 975 - 27142 (units: sqm) |
| Survey date date range: | 01/01/00 - 10/10/08 |
| Number of weekdays (Monday-Friday): | 11 |
| Number of Saturdays: | 0 |
| Number of Sundays: | 0 |
| Surveys manually removed from selection: | 0 |

TRIP RATE CALCULATION SELECTION PARAMETERS:

Land Use : 02 - EMPLOYMENT
 Category : B - BUSINESS PARK

MULTI-MODAL PUBLIC TRANSPORT USERS

Selected regions and areas:

| | | |
|--|--------------------|--------|
| 02 SOUTH EAST | | |
| BU | BUCKINGHAMSHIRE | 1 days |
| 03 SOUTH WEST | | |
| DC | DORSET | 1 days |
| WL | WILTSHIRE | 1 days |
| 04 EAST ANGLIA | | |
| SF | SUFFOLK | 1 days |
| 05 EAST MIDLANDS | | |
| LN | LINCOLNSHIRE | 1 days |
| NT | NOTTINGHAMSHIRE | 1 days |
| 06 WEST MIDLANDS | | |
| SH | SHROPSHIRE | 1 days |
| ST | STAFFORDSHIRE | 1 days |
| WO | WORCESTERSHIRE | 1 days |
| 07 YORKSHIRE & NORTH LINCOLNSHIRE | | |
| NO | NORTH LINCOLNSHIRE | 1 days |
| 09 NORTH | | |
| TW | TYNE & WEAR | 1 days |

Filtering Stage 2 selection:

Parameter: Gross floor area
 Range: 975 to 27142 (units: sqm)

Public Transport Provision:

Selection by: Include all surveys

Date Range: 01/01/00 to 10/10/08

Selected survey days:

| | |
|-----------|--------|
| Monday | 1 days |
| Tuesday | 3 days |
| Wednesday | 1 days |
| Thursday | 5 days |
| Friday | 1 days |

Selected survey types:

| | |
|-----------------------|---------|
| Manual count | 11 days |
| Directional ATC Count | 0 days |

Selected Locations:

| | |
|------------------------------------|---|
| Suburban Area (PPS6 Out of Centre) | 3 |
| Edge of Town | 8 |

Selected Location Sub Categories:

| | |
|------------------|---|
| Industrial Zone | 5 |
| Commercial Zone | 1 |
| Residential Zone | 2 |
| Built-Up Zone | 1 |
| No Sub Category | 2 |

TRIP RATE for Land Use 02 - EMPLOYMENT/B - BUSINESS PARK

MULTI-MODAL PUBLIC TRANSPORT USERS

Calculation factor: 100 sqm

Estimated TRIP rate value per 10000 SQM shown in shaded columns

BOLD print indicates peak (busiest) period

| Time Range | ARRIVALS | | | | DEPARTURES | | | | TOTALS | | | |
|---------------------|-----------|-------------|--------------|---------------------|------------|-------------|--------------|---------------------|-----------|-------------|--------------|---------------------|
| | No. Days | Ave. GFA | Trip Rate | Estimated Trip Rate | No. Days | Ave. GFA | Trip Rate | Estimated Trip Rate | No. Days | Ave. GFA | Trip Rate | Estimated Trip Rate |
| 00:00 - 00:30 | 0 | 0 | 0.000 | 0.000 | 0 | 0 | 0.000 | 0.000 | 0 | 0 | 0.000 | 0.000 |
| 00:30 - 01:00 | 0 | 0 | 0.000 | 0.000 | 0 | 0 | 0.000 | 0.000 | 0 | 0 | 0.000 | 0.000 |
| 01:00 - 01:30 | 0 | 0 | 0.000 | 0.000 | 0 | 0 | 0.000 | 0.000 | 0 | 0 | 0.000 | 0.000 |
| 01:30 - 02:00 | 0 | 0 | 0.000 | 0.000 | 0 | 0 | 0.000 | 0.000 | 0 | 0 | 0.000 | 0.000 |
| 02:00 - 02:30 | 0 | 0 | 0.000 | 0.000 | 0 | 0 | 0.000 | 0.000 | 0 | 0 | 0.000 | 0.000 |
| 02:30 - 03:00 | 0 | 0 | 0.000 | 0.000 | 0 | 0 | 0.000 | 0.000 | 0 | 0 | 0.000 | 0.000 |
| 03:00 - 03:30 | 0 | 0 | 0.000 | 0.000 | 0 | 0 | 0.000 | 0.000 | 0 | 0 | 0.000 | 0.000 |
| 03:30 - 04:00 | 0 | 0 | 0.000 | 0.000 | 0 | 0 | 0.000 | 0.000 | 0 | 0 | 0.000 | 0.000 |
| 04:00 - 04:30 | 0 | 0 | 0.000 | 0.000 | 0 | 0 | 0.000 | 0.000 | 0 | 0 | 0.000 | 0.000 |
| 04:30 - 05:00 | 0 | 0 | 0.000 | 0.000 | 0 | 0 | 0.000 | 0.000 | 0 | 0 | 0.000 | 0.000 |
| 05:00 - 05:30 | 0 | 0 | 0.000 | 0.000 | 0 | 0 | 0.000 | 0.000 | 0 | 0 | 0.000 | 0.000 |
| 05:30 - 06:00 | 0 | 0 | 0.000 | 0.000 | 0 | 0 | 0.000 | 0.000 | 0 | 0 | 0.000 | 0.000 |
| 06:00 - 06:30 | 0 | 0 | 0.000 | 0.000 | 0 | 0 | 0.000 | 0.000 | 0 | 0 | 0.000 | 0.000 |
| 06:30 - 07:00 | 0 | 0 | 0.000 | 0.000 | 0 | 0 | 0.000 | 0.000 | 0 | 0 | 0.000 | 0.000 |
| 07:00 - 07:30 | 11 | 7294 | 0.002 | 0.249 | 11 | 7294 | 0.000 | 0.000 | 11 | 7294 | 0.002 | 0.249 |
| 07:30 - 08:00 | 11 | 7294 | 0.014 | 1.371 | 11 | 7294 | 0.000 | 0.000 | 11 | 7294 | 0.014 | 1.371 |
| 08:00 - 08:30 | 11 | 7294 | 0.016 | 1.620 | 11 | 7294 | 0.001 | 0.125 | 11 | 7294 | 0.017 | 1.745 |
| 08:30 - 09:00 | 11 | 7294 | 0.025 | 2.493 | 11 | 7294 | 0.001 | 0.125 | 11 | 7294 | 0.026 | 2.618 |
| 09:00 - 09:30 | 11 | 7294 | 0.007 | 0.748 | 11 | 7294 | 0.001 | 0.125 | 11 | 7294 | 0.008 | 0.873 |
| 09:30 - 10:00 | 11 | 7294 | 0.004 | 0.374 | 11 | 7294 | 0.001 | 0.125 | 11 | 7294 | 0.005 | 0.499 |
| 10:00 - 10:30 | 11 | 7294 | 0.004 | 0.374 | 11 | 7294 | 0.002 | 0.249 | 11 | 7294 | 0.006 | 0.623 |
| 10:30 - 11:00 | 11 | 7294 | 0.006 | 0.623 | 11 | 7294 | 0.001 | 0.125 | 11 | 7294 | 0.007 | 0.748 |
| 11:00 - 11:30 | 11 | 7294 | 0.002 | 0.249 | 11 | 7294 | 0.005 | 0.499 | 11 | 7294 | 0.007 | 0.748 |
| 11:30 - 12:00 | 11 | 7294 | 0.000 | 0.000 | 11 | 7294 | 0.000 | 0.000 | 11 | 7294 | 0.000 | 0.000 |
| 12:00 - 12:30 | 11 | 7294 | 0.001 | 0.125 | 11 | 7294 | 0.002 | 0.249 | 11 | 7294 | 0.003 | 0.374 |
| 12:30 - 13:00 | 11 | 7294 | 0.001 | 0.125 | 11 | 7294 | 0.005 | 0.499 | 11 | 7294 | 0.006 | 0.624 |
| 13:00 - 13:30 | 11 | 7294 | 0.004 | 0.374 | 11 | 7294 | 0.001 | 0.125 | 11 | 7294 | 0.005 | 0.499 |
| 13:30 - 14:00 | 11 | 7294 | 0.001 | 0.125 | 11 | 7294 | 0.000 | 0.000 | 11 | 7294 | 0.001 | 0.125 |
| 14:00 - 14:30 | 11 | 7294 | 0.000 | 0.000 | 11 | 7294 | 0.002 | 0.249 | 11 | 7294 | 0.002 | 0.249 |
| 14:30 - 15:00 | 11 | 7294 | 0.000 | 0.000 | 11 | 7294 | 0.001 | 0.125 | 11 | 7294 | 0.001 | 0.125 |
| 15:00 - 15:30 | 11 | 7294 | 0.001 | 0.125 | 11 | 7294 | 0.004 | 0.374 | 11 | 7294 | 0.005 | 0.499 |
| 15:30 - 16:00 | 11 | 7294 | 0.000 | 0.000 | 11 | 7294 | 0.001 | 0.125 | 11 | 7294 | 0.001 | 0.125 |
| 16:00 - 16:30 | 11 | 7294 | 0.001 | 0.125 | 11 | 7294 | 0.002 | 0.249 | 11 | 7294 | 0.003 | 0.374 |
| 16:30 - 17:00 | 11 | 7294 | 0.000 | 0.000 | 11 | 7294 | 0.022 | 2.243 | 11 | 7294 | 0.022 | 2.243 |
| 17:00 - 17:30 | 11 | 7294 | 0.000 | 0.000 | 11 | 7294 | 0.010 | 0.997 | 11 | 7294 | 0.010 | 0.997 |
| 17:30 - 18:00 | 11 | 7294 | 0.000 | 0.000 | 11 | 7294 | 0.011 | 1.122 | 11 | 7294 | 0.011 | 1.122 |
| 18:00 - 18:30 | 11 | 7294 | 0.002 | 0.249 | 11 | 7294 | 0.002 | 0.249 | 11 | 7294 | 0.004 | 0.498 |
| 18:30 - 19:00 | 11 | 7294 | 0.000 | 0.000 | 11 | 7294 | 0.000 | 0.000 | 11 | 7294 | 0.000 | 0.000 |
| 19:00 - 19:30 | 0 | 0 | 0.000 | 0.000 | 0 | 0 | 0.000 | 0.000 | 0 | 0 | 0.000 | 0.000 |
| 19:30 - 20:00 | 0 | 0 | 0.000 | 0.000 | 0 | 0 | 0.000 | 0.000 | 0 | 0 | 0.000 | 0.000 |
| 20:00 - 20:30 | 0 | 0 | 0.000 | 0.000 | 0 | 0 | 0.000 | 0.000 | 0 | 0 | 0.000 | 0.000 |
| 20:30 - 21:00 | 0 | 0 | 0.000 | 0.000 | 0 | 0 | 0.000 | 0.000 | 0 | 0 | 0.000 | 0.000 |
| 21:00 - 21:30 | 0 | 0 | 0.000 | 0.000 | 0 | 0 | 0.000 | 0.000 | 0 | 0 | 0.000 | 0.000 |
| 21:30 - 22:00 | 0 | 0 | 0.000 | 0.000 | 0 | 0 | 0.000 | 0.000 | 0 | 0 | 0.000 | 0.000 |
| 22:00 - 22:30 | 0 | 0 | 0.000 | 0.000 | 0 | 0 | 0.000 | 0.000 | 0 | 0 | 0.000 | 0.000 |
| 22:30 - 23:00 | 0 | 0 | 0.000 | 0.000 | 0 | 0 | 0.000 | 0.000 | 0 | 0 | 0.000 | 0.000 |
| 23:00 - 23:30 | 0 | 0 | 0.000 | 0.000 | 0 | 0 | 0.000 | 0.000 | 0 | 0 | 0.000 | 0.000 |
| 23:30 - 24:00 | 0 | 0 | 0.000 | 0.000 | 0 | 0 | 0.000 | 0.000 | 0 | 0 | 0.000 | 0.000 |
| Total Rates: | | | 0.091 | 9.349 | | | 0.075 | 7.979 | | | 0.166 | 17.328 |

Parameter summary

| | |
|--|--------------------------|
| Trip rate parameter range selected: | 975 - 27142 (units: sqm) |
| Survey date date range: | 01/01/00 - 10/10/08 |
| Number of weekdays (Monday-Friday): | 11 |
| Number of Saturdays: | 0 |
| Number of Sundays: | 0 |
| Surveys manually removed from selection: | 0 |

TRIP RATE CALCULATION SELECTION PARAMETERS:

Land Use : 02 - EMPLOYMENT
 Category : B - BUSINESS PARK

MULTI-MODAL VEHICLES

Selected regions and areas:

| | | |
|--|--------------------|--------|
| 02 SOUTH EAST | | |
| BU | BUCKINGHAMSHIRE | 1 days |
| 03 SOUTH WEST | | |
| DC | DORSET | 1 days |
| WL | WILTSHIRE | 1 days |
| 04 EAST ANGLIA | | |
| SF | SUFFOLK | 1 days |
| 05 EAST MIDLANDS | | |
| LN | LINCOLNSHIRE | 1 days |
| NT | NOTTINGHAMSHIRE | 1 days |
| 06 WEST MIDLANDS | | |
| SH | SHROPSHIRE | 1 days |
| ST | STAFFORDSHIRE | 1 days |
| WO | WORCESTERSHIRE | 1 days |
| 07 YORKSHIRE & NORTH LINCOLNSHIRE | | |
| NO | NORTH LINCOLNSHIRE | 1 days |
| 09 NORTH | | |
| TW | TYNE & WEAR | 1 days |

Filtering Stage 2 selection:

Parameter: Gross floor area
 Range: 975 to 27142 (units: sqm)

Public Transport Provision:

Selection by: Include all surveys

Date Range: 01/01/00 to 10/10/08

Selected survey days:

| | |
|-----------|--------|
| Monday | 1 days |
| Tuesday | 3 days |
| Wednesday | 1 days |
| Thursday | 5 days |
| Friday | 1 days |

Selected survey types:

| | |
|-----------------------|---------|
| Manual count | 11 days |
| Directional ATC Count | 0 days |

Selected Locations:

| | |
|------------------------------------|---|
| Suburban Area (PPS6 Out of Centre) | 3 |
| Edge of Town | 8 |

Selected Location Sub Categories:

| | |
|------------------|---|
| Industrial Zone | 5 |
| Commercial Zone | 1 |
| Residential Zone | 2 |
| Built-Up Zone | 1 |
| No Sub Category | 2 |

TRIP RATE for Land Use 02 - EMPLOYMENT/B - BUSINESS PARK

MULTI-MODAL VEHICLES

Calculation factor: 100 sqm

Estimated TRIP rate value per 10000 SQM shown in shaded columns

BOLD print indicates peak (busiest) period

| Time Range | ARRIVALS | | | | DEPARTURES | | | | TOTALS | | | |
|---------------------|-----------|-------------|--------------|---------------------|------------|-------------|--------------|---------------------|-----------|-------------|--------------|---------------------|
| | No. Days | Ave. GFA | Trip Rate | Estimated Trip Rate | No. Days | Ave. GFA | Trip Rate | Estimated Trip Rate | No. Days | Ave. GFA | Trip Rate | Estimated Trip Rate |
| 00:00 - 00:30 | 0 | 0 | 0.000 | 0.000 | 0 | 0 | 0.000 | 0.000 | 0 | 0 | 0.000 | 0.000 |
| 00:30 - 01:00 | 0 | 0 | 0.000 | 0.000 | 0 | 0 | 0.000 | 0.000 | 0 | 0 | 0.000 | 0.000 |
| 01:00 - 01:30 | 0 | 0 | 0.000 | 0.000 | 0 | 0 | 0.000 | 0.000 | 0 | 0 | 0.000 | 0.000 |
| 01:30 - 02:00 | 0 | 0 | 0.000 | 0.000 | 0 | 0 | 0.000 | 0.000 | 0 | 0 | 0.000 | 0.000 |
| 02:00 - 02:30 | 0 | 0 | 0.000 | 0.000 | 0 | 0 | 0.000 | 0.000 | 0 | 0 | 0.000 | 0.000 |
| 02:30 - 03:00 | 0 | 0 | 0.000 | 0.000 | 0 | 0 | 0.000 | 0.000 | 0 | 0 | 0.000 | 0.000 |
| 03:00 - 03:30 | 0 | 0 | 0.000 | 0.000 | 0 | 0 | 0.000 | 0.000 | 0 | 0 | 0.000 | 0.000 |
| 03:30 - 04:00 | 0 | 0 | 0.000 | 0.000 | 0 | 0 | 0.000 | 0.000 | 0 | 0 | 0.000 | 0.000 |
| 04:00 - 04:30 | 0 | 0 | 0.000 | 0.000 | 0 | 0 | 0.000 | 0.000 | 0 | 0 | 0.000 | 0.000 |
| 04:30 - 05:00 | 0 | 0 | 0.000 | 0.000 | 0 | 0 | 0.000 | 0.000 | 0 | 0 | 0.000 | 0.000 |
| 05:00 - 05:30 | 0 | 0 | 0.000 | 0.000 | 0 | 0 | 0.000 | 0.000 | 0 | 0 | 0.000 | 0.000 |
| 05:30 - 06:00 | 0 | 0 | 0.000 | 0.000 | 0 | 0 | 0.000 | 0.000 | 0 | 0 | 0.000 | 0.000 |
| 06:00 - 06:30 | 0 | 0 | 0.000 | 0.000 | 0 | 0 | 0.000 | 0.000 | 0 | 0 | 0.000 | 0.000 |
| 06:30 - 07:00 | 0 | 0 | 0.000 | 0.000 | 0 | 0 | 0.000 | 0.000 | 0 | 0 | 0.000 | 0.000 |
| 07:00 - 07:30 | 11 | 7294 | 0.122 | 12.214 | 11 | 7294 | 0.042 | 4.238 | 11 | 7294 | 0.164 | 16.452 |
| 07:30 - 08:00 | 11 | 7294 | 0.312 | 31.159 | 11 | 7294 | 0.066 | 6.606 | 11 | 7294 | 0.378 | 37.765 |
| 08:00 - 08:30 | 11 | 7294 | 0.546 | 54.591 | 11 | 7294 | 0.145 | 14.458 | 11 | 7294 | 0.691 | 69.049 |
| 08:30 - 09:00 | 11 | 7294 | 0.818 | 81.762 | 11 | 7294 | 0.141 | 14.084 | 11 | 7294 | 0.959 | 95.846 |
| 09:00 - 09:30 | 11 | 7294 | 0.532 | 53.220 | 11 | 7294 | 0.173 | 17.325 | 11 | 7294 | 0.705 | 70.545 |
| 09:30 - 10:00 | 11 | 7294 | 0.290 | 29.040 | 11 | 7294 | 0.155 | 15.455 | 11 | 7294 | 0.445 | 44.495 |
| 10:00 - 10:30 | 11 | 7294 | 0.213 | 21.313 | 11 | 7294 | 0.173 | 17.325 | 11 | 7294 | 0.386 | 38.638 |
| 10:30 - 11:00 | 11 | 7294 | 0.156 | 15.580 | 11 | 7294 | 0.158 | 15.829 | 11 | 7294 | 0.314 | 31.409 |
| 11:00 - 11:30 | 11 | 7294 | 0.165 | 16.452 | 11 | 7294 | 0.206 | 20.565 | 11 | 7294 | 0.371 | 37.017 |
| 11:30 - 12:00 | 11 | 7294 | 0.163 | 16.327 | 11 | 7294 | 0.199 | 19.942 | 11 | 7294 | 0.362 | 36.269 |
| 12:00 - 12:30 | 11 | 7294 | 0.182 | 18.197 | 11 | 7294 | 0.375 | 37.516 | 11 | 7294 | 0.557 | 55.713 |
| 12:30 - 13:00 | 11 | 7294 | 0.228 | 22.809 | 11 | 7294 | 0.277 | 27.669 | 11 | 7294 | 0.505 | 50.478 |
| 13:00 - 13:30 | 11 | 7294 | 0.350 | 35.023 | 11 | 7294 | 0.315 | 31.533 | 11 | 7294 | 0.665 | 66.556 |
| 13:30 - 14:00 | 11 | 7294 | 0.328 | 32.780 | 11 | 7294 | 0.238 | 23.806 | 11 | 7294 | 0.566 | 56.586 |
| 14:00 - 14:30 | 11 | 7294 | 0.184 | 18.446 | 11 | 7294 | 0.138 | 13.835 | 11 | 7294 | 0.322 | 32.281 |
| 14:30 - 15:00 | 11 | 7294 | 0.183 | 18.322 | 11 | 7294 | 0.213 | 21.313 | 11 | 7294 | 0.396 | 39.635 |
| 15:00 - 15:30 | 11 | 7294 | 0.181 | 18.072 | 11 | 7294 | 0.259 | 25.924 | 11 | 7294 | 0.440 | 43.996 |
| 15:30 - 16:00 | 11 | 7294 | 0.177 | 17.698 | 11 | 7294 | 0.242 | 24.180 | 11 | 7294 | 0.419 | 41.878 |
| 16:00 - 16:30 | 11 | 7294 | 0.152 | 15.206 | 11 | 7294 | 0.304 | 30.411 | 11 | 7294 | 0.456 | 45.617 |
| 16:30 - 17:00 | 11 | 7294 | 0.116 | 11.591 | 11 | 7294 | 0.401 | 40.133 | 11 | 7294 | 0.517 | 51.724 |
| 17:00 - 17:30 | 11 | 7294 | 0.156 | 15.580 | 11 | 7294 | 0.653 | 65.310 | 11 | 7294 | 0.809 | 80.890 |
| 17:30 - 18:00 | 11 | 7294 | 0.079 | 7.852 | 11 | 7294 | 0.533 | 53.345 | 11 | 7294 | 0.612 | 61.197 |
| 18:00 - 18:30 | 11 | 7294 | 0.042 | 4.238 | 11 | 7294 | 0.231 | 23.058 | 11 | 7294 | 0.273 | 27.296 |
| 18:30 - 19:00 | 11 | 7294 | 0.021 | 2.119 | 11 | 7294 | 0.103 | 10.345 | 11 | 7294 | 0.124 | 12.464 |
| 19:00 - 19:30 | 0 | 0 | 0.000 | 0.000 | 0 | 0 | 0.000 | 0.000 | 0 | 0 | 0.000 | 0.000 |
| 19:30 - 20:00 | 0 | 0 | 0.000 | 0.000 | 0 | 0 | 0.000 | 0.000 | 0 | 0 | 0.000 | 0.000 |
| 20:00 - 20:30 | 0 | 0 | 0.000 | 0.000 | 0 | 0 | 0.000 | 0.000 | 0 | 0 | 0.000 | 0.000 |
| 20:30 - 21:00 | 0 | 0 | 0.000 | 0.000 | 0 | 0 | 0.000 | 0.000 | 0 | 0 | 0.000 | 0.000 |
| 21:00 - 21:30 | 0 | 0 | 0.000 | 0.000 | 0 | 0 | 0.000 | 0.000 | 0 | 0 | 0.000 | 0.000 |
| 21:30 - 22:00 | 0 | 0 | 0.000 | 0.000 | 0 | 0 | 0.000 | 0.000 | 0 | 0 | 0.000 | 0.000 |
| 22:00 - 22:30 | 0 | 0 | 0.000 | 0.000 | 0 | 0 | 0.000 | 0.000 | 0 | 0 | 0.000 | 0.000 |
| 22:30 - 23:00 | 0 | 0 | 0.000 | 0.000 | 0 | 0 | 0.000 | 0.000 | 0 | 0 | 0.000 | 0.000 |
| 23:00 - 23:30 | 0 | 0 | 0.000 | 0.000 | 0 | 0 | 0.000 | 0.000 | 0 | 0 | 0.000 | 0.000 |
| 23:30 - 24:00 | 0 | 0 | 0.000 | 0.000 | 0 | 0 | 0.000 | 0.000 | 0 | 0 | 0.000 | 0.000 |
| Total Rates: | | | 5.696 | 569.591 | | | 5.740 | 574.205 | | | 11.436 | 1143.796 |

Parameter summary

| | |
|--|--------------------------|
| Trip rate parameter range selected: | 975 - 27142 (units: sqm) |
| Survey date date range: | 01/01/00 - 10/10/08 |
| Number of weekdays (Monday-Friday): | 11 |
| Number of Saturdays: | 0 |
| Number of Sundays: | 0 |
| Surveys manually removed from selection: | 0 |

TRIP RATE CALCULATION SELECTION PARAMETERS:

Land Use : 02 - EMPLOYMENT
 Category : B - BUSINESS PARK

MULTI-MODAL CYCLISTS

Selected regions and areas:

| | | |
|--|--------------------|--------|
| 02 SOUTH EAST | | |
| BU | BUCKINGHAMSHIRE | 1 days |
| 03 SOUTH WEST | | |
| DC | DORSET | 1 days |
| WL | WILTSHIRE | 1 days |
| 04 EAST ANGLIA | | |
| SF | SUFFOLK | 1 days |
| 05 EAST MIDLANDS | | |
| LN | LINCOLNSHIRE | 1 days |
| NT | NOTTINGHAMSHIRE | 1 days |
| 06 WEST MIDLANDS | | |
| SH | SHROPSHIRE | 1 days |
| ST | STAFFORDSHIRE | 1 days |
| WO | WORCESTERSHIRE | 1 days |
| 07 YORKSHIRE & NORTH LINCOLNSHIRE | | |
| NO | NORTH LINCOLNSHIRE | 1 days |
| 09 NORTH | | |
| TW | TYNE & WEAR | 1 days |

Filtering Stage 2 selection:

Parameter: Gross floor area
 Range: 975 to 27142 (units: sqm)

Public Transport Provision:

Selection by: Include all surveys

Date Range: 01/01/00 to 10/10/08

Selected survey days:

| | |
|-----------|--------|
| Monday | 1 days |
| Tuesday | 3 days |
| Wednesday | 1 days |
| Thursday | 5 days |
| Friday | 1 days |

Selected survey types:

| | |
|-----------------------|---------|
| Manual count | 11 days |
| Directional ATC Count | 0 days |

Selected Locations:

| | |
|------------------------------------|---|
| Suburban Area (PPS6 Out of Centre) | 3 |
| Edge of Town | 8 |

Selected Location Sub Categories:

| | |
|------------------|---|
| Industrial Zone | 5 |
| Commercial Zone | 1 |
| Residential Zone | 2 |
| Built-Up Zone | 1 |
| No Sub Category | 2 |

TRIP RATE for Land Use 02 - EMPLOYMENT/B - BUSINESS PARK

MULTI-MODAL CYCLISTS

Calculation factor: 100 sqm

Estimated TRIP rate value per 20000 SQM shown in shaded columns

BOLD print indicates peak (busiest) period

| Time Range | ARRIVALS | | | | DEPARTURES | | | | TOTALS | | | |
|---------------------|-----------|-------------|--------------|---------------------|------------|-------------|--------------|---------------------|-----------|-------------|--------------|---------------------|
| | No. Days | Ave. GFA | Trip Rate | Estimated Trip Rate | No. Days | Ave. GFA | Trip Rate | Estimated Trip Rate | No. Days | Ave. GFA | Trip Rate | Estimated Trip Rate |
| 00:00 - 00:30 | 0 | 0 | 0.000 | 0.000 | 0 | 0 | 0.000 | 0.000 | 0 | 0 | 0.000 | 0.000 |
| 00:30 - 01:00 | 0 | 0 | 0.000 | 0.000 | 0 | 0 | 0.000 | 0.000 | 0 | 0 | 0.000 | 0.000 |
| 01:00 - 01:30 | 0 | 0 | 0.000 | 0.000 | 0 | 0 | 0.000 | 0.000 | 0 | 0 | 0.000 | 0.000 |
| 01:30 - 02:00 | 0 | 0 | 0.000 | 0.000 | 0 | 0 | 0.000 | 0.000 | 0 | 0 | 0.000 | 0.000 |
| 02:00 - 02:30 | 0 | 0 | 0.000 | 0.000 | 0 | 0 | 0.000 | 0.000 | 0 | 0 | 0.000 | 0.000 |
| 02:30 - 03:00 | 0 | 0 | 0.000 | 0.000 | 0 | 0 | 0.000 | 0.000 | 0 | 0 | 0.000 | 0.000 |
| 03:00 - 03:30 | 0 | 0 | 0.000 | 0.000 | 0 | 0 | 0.000 | 0.000 | 0 | 0 | 0.000 | 0.000 |
| 03:30 - 04:00 | 0 | 0 | 0.000 | 0.000 | 0 | 0 | 0.000 | 0.000 | 0 | 0 | 0.000 | 0.000 |
| 04:00 - 04:30 | 0 | 0 | 0.000 | 0.000 | 0 | 0 | 0.000 | 0.000 | 0 | 0 | 0.000 | 0.000 |
| 04:30 - 05:00 | 0 | 0 | 0.000 | 0.000 | 0 | 0 | 0.000 | 0.000 | 0 | 0 | 0.000 | 0.000 |
| 05:00 - 05:30 | 0 | 0 | 0.000 | 0.000 | 0 | 0 | 0.000 | 0.000 | 0 | 0 | 0.000 | 0.000 |
| 05:30 - 06:00 | 0 | 0 | 0.000 | 0.000 | 0 | 0 | 0.000 | 0.000 | 0 | 0 | 0.000 | 0.000 |
| 06:00 - 06:30 | 0 | 0 | 0.000 | 0.000 | 0 | 0 | 0.000 | 0.000 | 0 | 0 | 0.000 | 0.000 |
| 06:30 - 07:00 | 0 | 0 | 0.000 | 0.000 | 0 | 0 | 0.000 | 0.000 | 0 | 0 | 0.000 | 0.000 |
| 07:00 - 07:30 | 11 | 7294 | 0.005 | 0.997 | 11 | 7294 | 0.001 | 0.249 | 11 | 7294 | 0.006 | 1.246 |
| 07:30 - 08:00 | 11 | 7294 | 0.004 | 0.748 | 11 | 7294 | 0.002 | 0.499 | 11 | 7294 | 0.006 | 1.247 |
| 08:00 - 08:30 | 11 | 7294 | 0.015 | 2.991 | 11 | 7294 | 0.001 | 0.249 | 11 | 7294 | 0.016 | 3.240 |
| 08:30 - 09:00 | 11 | 7294 | 0.010 | 1.994 | 11 | 7294 | 0.000 | 0.000 | 11 | 7294 | 0.010 | 1.994 |
| 09:00 - 09:30 | 11 | 7294 | 0.009 | 1.745 | 11 | 7294 | 0.001 | 0.249 | 11 | 7294 | 0.010 | 1.994 |
| 09:30 - 10:00 | 11 | 7294 | 0.005 | 0.997 | 11 | 7294 | 0.000 | 0.000 | 11 | 7294 | 0.005 | 0.997 |
| 10:00 - 10:30 | 11 | 7294 | 0.001 | 0.249 | 11 | 7294 | 0.001 | 0.249 | 11 | 7294 | 0.002 | 0.498 |
| 10:30 - 11:00 | 11 | 7294 | 0.002 | 0.499 | 11 | 7294 | 0.001 | 0.249 | 11 | 7294 | 0.003 | 0.748 |
| 11:00 - 11:30 | 11 | 7294 | 0.002 | 0.499 | 11 | 7294 | 0.002 | 0.499 | 11 | 7294 | 0.004 | 0.998 |
| 11:30 - 12:00 | 11 | 7294 | 0.002 | 0.499 | 11 | 7294 | 0.001 | 0.249 | 11 | 7294 | 0.003 | 0.748 |
| 12:00 - 12:30 | 11 | 7294 | 0.001 | 0.249 | 11 | 7294 | 0.005 | 0.997 | 11 | 7294 | 0.006 | 1.246 |
| 12:30 - 13:00 | 11 | 7294 | 0.002 | 0.499 | 11 | 7294 | 0.001 | 0.249 | 11 | 7294 | 0.003 | 0.748 |
| 13:00 - 13:30 | 11 | 7294 | 0.002 | 0.499 | 11 | 7294 | 0.004 | 0.748 | 11 | 7294 | 0.006 | 1.247 |
| 13:30 - 14:00 | 11 | 7294 | 0.002 | 0.499 | 11 | 7294 | 0.005 | 0.997 | 11 | 7294 | 0.007 | 1.496 |
| 14:00 - 14:30 | 11 | 7294 | 0.000 | 0.000 | 11 | 7294 | 0.001 | 0.249 | 11 | 7294 | 0.001 | 0.249 |
| 14:30 - 15:00 | 11 | 7294 | 0.000 | 0.000 | 11 | 7294 | 0.004 | 0.748 | 11 | 7294 | 0.004 | 0.748 |
| 15:00 - 15:30 | 11 | 7294 | 0.000 | 0.000 | 11 | 7294 | 0.000 | 0.000 | 11 | 7294 | 0.000 | 0.000 |
| 15:30 - 16:00 | 11 | 7294 | 0.000 | 0.000 | 11 | 7294 | 0.004 | 0.748 | 11 | 7294 | 0.004 | 0.748 |
| 16:00 - 16:30 | 11 | 7294 | 0.001 | 0.249 | 11 | 7294 | 0.010 | 1.994 | 11 | 7294 | 0.011 | 2.243 |
| 16:30 - 17:00 | 11 | 7294 | 0.002 | 0.499 | 11 | 7294 | 0.005 | 0.997 | 11 | 7294 | 0.007 | 1.496 |
| 17:00 - 17:30 | 11 | 7294 | 0.000 | 0.000 | 11 | 7294 | 0.006 | 1.246 | 11 | 7294 | 0.006 | 1.246 |
| 17:30 - 18:00 | 11 | 7294 | 0.000 | 0.000 | 11 | 7294 | 0.009 | 1.745 | 11 | 7294 | 0.009 | 1.745 |
| 18:00 - 18:30 | 11 | 7294 | 0.000 | 0.000 | 11 | 7294 | 0.002 | 0.499 | 11 | 7294 | 0.002 | 0.499 |
| 18:30 - 19:00 | 11 | 7294 | 0.000 | 0.000 | 11 | 7294 | 0.000 | 0.000 | 11 | 7294 | 0.000 | 0.000 |
| 19:00 - 19:30 | 0 | 0 | 0.000 | 0.000 | 0 | 0 | 0.000 | 0.000 | 0 | 0 | 0.000 | 0.000 |
| 19:30 - 20:00 | 0 | 0 | 0.000 | 0.000 | 0 | 0 | 0.000 | 0.000 | 0 | 0 | 0.000 | 0.000 |
| 20:00 - 20:30 | 0 | 0 | 0.000 | 0.000 | 0 | 0 | 0.000 | 0.000 | 0 | 0 | 0.000 | 0.000 |
| 20:30 - 21:00 | 0 | 0 | 0.000 | 0.000 | 0 | 0 | 0.000 | 0.000 | 0 | 0 | 0.000 | 0.000 |
| 21:00 - 21:30 | 0 | 0 | 0.000 | 0.000 | 0 | 0 | 0.000 | 0.000 | 0 | 0 | 0.000 | 0.000 |
| 21:30 - 22:00 | 0 | 0 | 0.000 | 0.000 | 0 | 0 | 0.000 | 0.000 | 0 | 0 | 0.000 | 0.000 |
| 22:00 - 22:30 | 0 | 0 | 0.000 | 0.000 | 0 | 0 | 0.000 | 0.000 | 0 | 0 | 0.000 | 0.000 |
| 22:30 - 23:00 | 0 | 0 | 0.000 | 0.000 | 0 | 0 | 0.000 | 0.000 | 0 | 0 | 0.000 | 0.000 |
| 23:00 - 23:30 | 0 | 0 | 0.000 | 0.000 | 0 | 0 | 0.000 | 0.000 | 0 | 0 | 0.000 | 0.000 |
| 23:30 - 24:00 | 0 | 0 | 0.000 | 0.000 | 0 | 0 | 0.000 | 0.000 | 0 | 0 | 0.000 | 0.000 |
| Total Rates: | | | 0.065 | 13.712 | | | 0.066 | 13.709 | | | 0.131 | 27.421 |

Parameter summary

| | |
|--|--------------------------|
| Trip rate parameter range selected: | 975 - 27142 (units: sqm) |
| Survey date date range: | 01/01/00 - 10/10/08 |
| Number of weekdays (Monday-Friday): | 11 |
| Number of Saturdays: | 0 |
| Number of Sundays: | 0 |
| Surveys manually removed from selection: | 0 |

TRIP RATE CALCULATION SELECTION PARAMETERS:

Land Use : 02 - EMPLOYMENT
 Category : B - BUSINESS PARK

MULTI-MODAL PEDESTRIANS

Selected regions and areas:

| | | |
|--|--------------------|--------|
| 02 SOUTH EAST | | |
| BU | BUCKINGHAMSHIRE | 1 days |
| 03 SOUTH WEST | | |
| DC | DORSET | 1 days |
| WL | WILTSHIRE | 1 days |
| 04 EAST ANGLIA | | |
| SF | SUFFOLK | 1 days |
| 05 EAST MIDLANDS | | |
| LN | LINCOLNSHIRE | 1 days |
| NT | NOTTINGHAMSHIRE | 1 days |
| 06 WEST MIDLANDS | | |
| SH | SHROPSHIRE | 1 days |
| ST | STAFFORDSHIRE | 1 days |
| WO | WORCESTERSHIRE | 1 days |
| 07 YORKSHIRE & NORTH LINCOLNSHIRE | | |
| NO | NORTH LINCOLNSHIRE | 1 days |
| 09 NORTH | | |
| TW | TYNE & WEAR | 1 days |

Filtering Stage 2 selection:

Parameter: Gross floor area
 Range: 975 to 27142 (units: sqm)

Public Transport Provision:

Selection by: Include all surveys

Date Range: 01/01/00 to 10/10/08

Selected survey days:

| | |
|-----------|--------|
| Monday | 1 days |
| Tuesday | 3 days |
| Wednesday | 1 days |
| Thursday | 5 days |
| Friday | 1 days |

Selected survey types:

| | |
|-----------------------|---------|
| Manual count | 11 days |
| Directional ATC Count | 0 days |

Selected Locations:

| | |
|------------------------------------|---|
| Suburban Area (PPS6 Out of Centre) | 3 |
| Edge of Town | 8 |

Selected Location Sub Categories:

| | |
|------------------|---|
| Industrial Zone | 5 |
| Commercial Zone | 1 |
| Residential Zone | 2 |
| Built-Up Zone | 1 |
| No Sub Category | 2 |

TRIP RATE for Land Use 02 - EMPLOYMENT/B - BUSINESS PARK

MULTI-MODAL PEDESTRIANS

Calculation factor: 100 sqm

Estimated TRIP rate value per 20000 SQM shown in shaded columns

BOLD print indicates peak (busiest) period

| Time Range | ARRIVALS | | | | DEPARTURES | | | | TOTALS | | | |
|---------------------|-----------|-------------|--------------|---------------------|------------|-------------|--------------|---------------------|-----------|-------------|--------------|---------------------|
| | No. Days | Ave. GFA | Trip Rate | Estimated Trip Rate | No. Days | Ave. GFA | Trip Rate | Estimated Trip Rate | No. Days | Ave. GFA | Trip Rate | Estimated Trip Rate |
| 00:00 - 00:30 | 0 | 0 | 0.000 | 0.000 | 0 | 0 | 0.000 | 0.000 | 0 | 0 | 0.000 | 0.000 |
| 00:30 - 01:00 | 0 | 0 | 0.000 | 0.000 | 0 | 0 | 0.000 | 0.000 | 0 | 0 | 0.000 | 0.000 |
| 01:00 - 01:30 | 0 | 0 | 0.000 | 0.000 | 0 | 0 | 0.000 | 0.000 | 0 | 0 | 0.000 | 0.000 |
| 01:30 - 02:00 | 0 | 0 | 0.000 | 0.000 | 0 | 0 | 0.000 | 0.000 | 0 | 0 | 0.000 | 0.000 |
| 02:00 - 02:30 | 0 | 0 | 0.000 | 0.000 | 0 | 0 | 0.000 | 0.000 | 0 | 0 | 0.000 | 0.000 |
| 02:30 - 03:00 | 0 | 0 | 0.000 | 0.000 | 0 | 0 | 0.000 | 0.000 | 0 | 0 | 0.000 | 0.000 |
| 03:00 - 03:30 | 0 | 0 | 0.000 | 0.000 | 0 | 0 | 0.000 | 0.000 | 0 | 0 | 0.000 | 0.000 |
| 03:30 - 04:00 | 0 | 0 | 0.000 | 0.000 | 0 | 0 | 0.000 | 0.000 | 0 | 0 | 0.000 | 0.000 |
| 04:00 - 04:30 | 0 | 0 | 0.000 | 0.000 | 0 | 0 | 0.000 | 0.000 | 0 | 0 | 0.000 | 0.000 |
| 04:30 - 05:00 | 0 | 0 | 0.000 | 0.000 | 0 | 0 | 0.000 | 0.000 | 0 | 0 | 0.000 | 0.000 |
| 05:00 - 05:30 | 0 | 0 | 0.000 | 0.000 | 0 | 0 | 0.000 | 0.000 | 0 | 0 | 0.000 | 0.000 |
| 05:30 - 06:00 | 0 | 0 | 0.000 | 0.000 | 0 | 0 | 0.000 | 0.000 | 0 | 0 | 0.000 | 0.000 |
| 06:00 - 06:30 | 0 | 0 | 0.000 | 0.000 | 0 | 0 | 0.000 | 0.000 | 0 | 0 | 0.000 | 0.000 |
| 06:30 - 07:00 | 0 | 0 | 0.000 | 0.000 | 0 | 0 | 0.000 | 0.000 | 0 | 0 | 0.000 | 0.000 |
| 07:00 - 07:30 | 11 | 7294 | 0.004 | 0.748 | 11 | 7294 | 0.000 | 0.000 | 11 | 7294 | 0.004 | 0.748 |
| 07:30 - 08:00 | 11 | 7294 | 0.010 | 1.994 | 11 | 7294 | 0.004 | 0.748 | 11 | 7294 | 0.014 | 2.742 |
| 08:00 - 08:30 | 11 | 7294 | 0.042 | 8.475 | 11 | 7294 | 0.005 | 0.997 | 11 | 7294 | 0.047 | 9.472 |
| 08:30 - 09:00 | 11 | 7294 | 0.062 | 12.464 | 11 | 7294 | 0.001 | 0.249 | 11 | 7294 | 0.063 | 12.713 |
| 09:00 - 09:30 | 11 | 7294 | 0.012 | 2.493 | 11 | 7294 | 0.000 | 0.000 | 11 | 7294 | 0.012 | 2.493 |
| 09:30 - 10:00 | 11 | 7294 | 0.022 | 4.487 | 11 | 7294 | 0.012 | 2.493 | 11 | 7294 | 0.034 | 6.980 |
| 10:00 - 10:30 | 11 | 7294 | 0.022 | 4.487 | 11 | 7294 | 0.012 | 2.493 | 11 | 7294 | 0.034 | 6.980 |
| 10:30 - 11:00 | 11 | 7294 | 0.011 | 2.243 | 11 | 7294 | 0.006 | 1.246 | 11 | 7294 | 0.017 | 3.489 |
| 11:00 - 11:30 | 11 | 7294 | 0.006 | 1.246 | 11 | 7294 | 0.001 | 0.249 | 11 | 7294 | 0.007 | 1.495 |
| 11:30 - 12:00 | 11 | 7294 | 0.012 | 2.493 | 11 | 7294 | 0.024 | 4.736 | 11 | 7294 | 0.036 | 7.229 |
| 12:00 - 12:30 | 11 | 7294 | 0.035 | 6.980 | 11 | 7294 | 0.022 | 4.487 | 11 | 7294 | 0.057 | 11.467 |
| 12:30 - 13:00 | 11 | 7294 | 0.035 | 6.980 | 11 | 7294 | 0.035 | 6.980 | 11 | 7294 | 0.070 | 13.960 |
| 13:00 - 13:30 | 11 | 7294 | 0.040 | 7.977 | 11 | 7294 | 0.055 | 10.968 | 11 | 7294 | 0.095 | 18.945 |
| 13:30 - 14:00 | 11 | 7294 | 0.042 | 8.475 | 11 | 7294 | 0.034 | 6.730 | 11 | 7294 | 0.076 | 15.205 |
| 14:00 - 14:30 | 11 | 7294 | 0.016 | 3.241 | 11 | 7294 | 0.014 | 2.742 | 11 | 7294 | 0.030 | 5.983 |
| 14:30 - 15:00 | 11 | 7294 | 0.017 | 3.490 | 11 | 7294 | 0.007 | 1.496 | 11 | 7294 | 0.024 | 4.986 |
| 15:00 - 15:30 | 11 | 7294 | 0.004 | 0.748 | 11 | 7294 | 0.005 | 0.997 | 11 | 7294 | 0.009 | 1.745 |
| 15:30 - 16:00 | 11 | 7294 | 0.009 | 1.745 | 11 | 7294 | 0.010 | 1.994 | 11 | 7294 | 0.019 | 3.739 |
| 16:00 - 16:30 | 11 | 7294 | 0.004 | 0.748 | 11 | 7294 | 0.015 | 2.991 | 11 | 7294 | 0.019 | 3.739 |
| 16:30 - 17:00 | 11 | 7294 | 0.006 | 1.246 | 11 | 7294 | 0.020 | 3.988 | 11 | 7294 | 0.026 | 5.234 |
| 17:00 - 17:30 | 11 | 7294 | 0.006 | 1.246 | 11 | 7294 | 0.050 | 9.971 | 11 | 7294 | 0.056 | 11.217 |
| 17:30 - 18:00 | 11 | 7294 | 0.012 | 2.493 | 11 | 7294 | 0.035 | 6.980 | 11 | 7294 | 0.047 | 9.473 |
| 18:00 - 18:30 | 11 | 7294 | 0.002 | 0.499 | 11 | 7294 | 0.011 | 2.243 | 11 | 7294 | 0.013 | 2.742 |
| 18:30 - 19:00 | 11 | 7294 | 0.000 | 0.000 | 11 | 7294 | 0.004 | 0.748 | 11 | 7294 | 0.004 | 0.748 |
| 19:00 - 19:30 | 0 | 0 | 0.000 | 0.000 | 0 | 0 | 0.000 | 0.000 | 0 | 0 | 0.000 | 0.000 |
| 19:30 - 20:00 | 0 | 0 | 0.000 | 0.000 | 0 | 0 | 0.000 | 0.000 | 0 | 0 | 0.000 | 0.000 |
| 20:00 - 20:30 | 0 | 0 | 0.000 | 0.000 | 0 | 0 | 0.000 | 0.000 | 0 | 0 | 0.000 | 0.000 |
| 20:30 - 21:00 | 0 | 0 | 0.000 | 0.000 | 0 | 0 | 0.000 | 0.000 | 0 | 0 | 0.000 | 0.000 |
| 21:00 - 21:30 | 0 | 0 | 0.000 | 0.000 | 0 | 0 | 0.000 | 0.000 | 0 | 0 | 0.000 | 0.000 |
| 21:30 - 22:00 | 0 | 0 | 0.000 | 0.000 | 0 | 0 | 0.000 | 0.000 | 0 | 0 | 0.000 | 0.000 |
| 22:00 - 22:30 | 0 | 0 | 0.000 | 0.000 | 0 | 0 | 0.000 | 0.000 | 0 | 0 | 0.000 | 0.000 |
| 22:30 - 23:00 | 0 | 0 | 0.000 | 0.000 | 0 | 0 | 0.000 | 0.000 | 0 | 0 | 0.000 | 0.000 |
| 23:00 - 23:30 | 0 | 0 | 0.000 | 0.000 | 0 | 0 | 0.000 | 0.000 | 0 | 0 | 0.000 | 0.000 |
| 23:30 - 24:00 | 0 | 0 | 0.000 | 0.000 | 0 | 0 | 0.000 | 0.000 | 0 | 0 | 0.000 | 0.000 |
| Total Rates: | | | 0.431 | 86.998 | | | 0.382 | 76.526 | | | 0.813 | 163.524 |

Parameter summary

| | |
|--|--------------------------|
| Trip rate parameter range selected: | 975 - 27142 (units: sqm) |
| Survey date date range: | 01/01/00 - 10/10/08 |
| Number of weekdays (Monday-Friday): | 11 |
| Number of Saturdays: | 0 |
| Number of Sundays: | 0 |
| Surveys manually removed from selection: | 0 |

TRIP RATE CALCULATION SELECTION PARAMETERS:

Land Use : 02 - EMPLOYMENT
 Category : B - BUSINESS PARK

MULTI-MODAL PUBLIC TRANSPORT USERS

Selected regions and areas:

| | | |
|--|--------------------|--------|
| 02 SOUTH EAST | | |
| BU | BUCKINGHAMSHIRE | 1 days |
| 03 SOUTH WEST | | |
| DC | DORSET | 1 days |
| WL | WILTSHIRE | 1 days |
| 04 EAST ANGLIA | | |
| SF | SUFFOLK | 1 days |
| 05 EAST MIDLANDS | | |
| LN | LINCOLNSHIRE | 1 days |
| NT | NOTTINGHAMSHIRE | 1 days |
| 06 WEST MIDLANDS | | |
| SH | SHROPSHIRE | 1 days |
| ST | STAFFORDSHIRE | 1 days |
| WO | WORCESTERSHIRE | 1 days |
| 07 YORKSHIRE & NORTH LINCOLNSHIRE | | |
| NO | NORTH LINCOLNSHIRE | 1 days |
| 09 NORTH | | |
| TW | TYNE & WEAR | 1 days |

Filtering Stage 2 selection:

Parameter: Gross floor area
 Range: 975 to 27142 (units: sqm)

Public Transport Provision:

Selection by: Include all surveys

Date Range: 01/01/00 to 10/10/08

Selected survey days:

| | |
|-----------|--------|
| Monday | 1 days |
| Tuesday | 3 days |
| Wednesday | 1 days |
| Thursday | 5 days |
| Friday | 1 days |

Selected survey types:

| | |
|-----------------------|---------|
| Manual count | 11 days |
| Directional ATC Count | 0 days |

Selected Locations:

| | |
|------------------------------------|---|
| Suburban Area (PPS6 Out of Centre) | 3 |
| Edge of Town | 8 |

Selected Location Sub Categories:

| | |
|------------------|---|
| Industrial Zone | 5 |
| Commercial Zone | 1 |
| Residential Zone | 2 |
| Built-Up Zone | 1 |
| No Sub Category | 2 |

TRIP RATE for Land Use 02 - EMPLOYMENT/B - BUSINESS PARK

MULTI-MODAL PUBLIC TRANSPORT USERS

Calculation factor: 100 sqm

Estimated TRIP rate value per 20000 SQM shown in shaded columns

BOLD print indicates peak (busiest) period

| Time Range | ARRIVALS | | | | DEPARTURES | | | | TOTALS | | | |
|---------------------|-----------|-------------|--------------|---------------------|------------|-------------|--------------|---------------------|-----------|-------------|--------------|---------------------|
| | No. Days | Ave. GFA | Trip Rate | Estimated Trip Rate | No. Days | Ave. GFA | Trip Rate | Estimated Trip Rate | No. Days | Ave. GFA | Trip Rate | Estimated Trip Rate |
| 00:00 - 00:30 | 0 | 0 | 0.000 | 0.000 | 0 | 0 | 0.000 | 0.000 | 0 | 0 | 0.000 | 0.000 |
| 00:30 - 01:00 | 0 | 0 | 0.000 | 0.000 | 0 | 0 | 0.000 | 0.000 | 0 | 0 | 0.000 | 0.000 |
| 01:00 - 01:30 | 0 | 0 | 0.000 | 0.000 | 0 | 0 | 0.000 | 0.000 | 0 | 0 | 0.000 | 0.000 |
| 01:30 - 02:00 | 0 | 0 | 0.000 | 0.000 | 0 | 0 | 0.000 | 0.000 | 0 | 0 | 0.000 | 0.000 |
| 02:00 - 02:30 | 0 | 0 | 0.000 | 0.000 | 0 | 0 | 0.000 | 0.000 | 0 | 0 | 0.000 | 0.000 |
| 02:30 - 03:00 | 0 | 0 | 0.000 | 0.000 | 0 | 0 | 0.000 | 0.000 | 0 | 0 | 0.000 | 0.000 |
| 03:00 - 03:30 | 0 | 0 | 0.000 | 0.000 | 0 | 0 | 0.000 | 0.000 | 0 | 0 | 0.000 | 0.000 |
| 03:30 - 04:00 | 0 | 0 | 0.000 | 0.000 | 0 | 0 | 0.000 | 0.000 | 0 | 0 | 0.000 | 0.000 |
| 04:00 - 04:30 | 0 | 0 | 0.000 | 0.000 | 0 | 0 | 0.000 | 0.000 | 0 | 0 | 0.000 | 0.000 |
| 04:30 - 05:00 | 0 | 0 | 0.000 | 0.000 | 0 | 0 | 0.000 | 0.000 | 0 | 0 | 0.000 | 0.000 |
| 05:00 - 05:30 | 0 | 0 | 0.000 | 0.000 | 0 | 0 | 0.000 | 0.000 | 0 | 0 | 0.000 | 0.000 |
| 05:30 - 06:00 | 0 | 0 | 0.000 | 0.000 | 0 | 0 | 0.000 | 0.000 | 0 | 0 | 0.000 | 0.000 |
| 06:00 - 06:30 | 0 | 0 | 0.000 | 0.000 | 0 | 0 | 0.000 | 0.000 | 0 | 0 | 0.000 | 0.000 |
| 06:30 - 07:00 | 0 | 0 | 0.000 | 0.000 | 0 | 0 | 0.000 | 0.000 | 0 | 0 | 0.000 | 0.000 |
| 07:00 - 07:30 | 11 | 7294 | 0.002 | 0.499 | 11 | 7294 | 0.000 | 0.000 | 11 | 7294 | 0.002 | 0.499 |
| 07:30 - 08:00 | 11 | 7294 | 0.014 | 2.742 | 11 | 7294 | 0.000 | 0.000 | 11 | 7294 | 0.014 | 2.742 |
| 08:00 - 08:30 | 11 | 7294 | 0.016 | 3.241 | 11 | 7294 | 0.001 | 0.249 | 11 | 7294 | 0.017 | 3.490 |
| 08:30 - 09:00 | 11 | 7294 | 0.025 | 4.985 | 11 | 7294 | 0.001 | 0.249 | 11 | 7294 | 0.026 | 5.234 |
| 09:00 - 09:30 | 11 | 7294 | 0.007 | 1.496 | 11 | 7294 | 0.001 | 0.249 | 11 | 7294 | 0.008 | 1.745 |
| 09:30 - 10:00 | 11 | 7294 | 0.004 | 0.748 | 11 | 7294 | 0.001 | 0.249 | 11 | 7294 | 0.005 | 0.997 |
| 10:00 - 10:30 | 11 | 7294 | 0.004 | 0.748 | 11 | 7294 | 0.002 | 0.499 | 11 | 7294 | 0.006 | 1.247 |
| 10:30 - 11:00 | 11 | 7294 | 0.006 | 1.246 | 11 | 7294 | 0.001 | 0.249 | 11 | 7294 | 0.007 | 1.495 |
| 11:00 - 11:30 | 11 | 7294 | 0.002 | 0.499 | 11 | 7294 | 0.005 | 0.997 | 11 | 7294 | 0.007 | 1.496 |
| 11:30 - 12:00 | 11 | 7294 | 0.000 | 0.000 | 11 | 7294 | 0.000 | 0.000 | 11 | 7294 | 0.000 | 0.000 |
| 12:00 - 12:30 | 11 | 7294 | 0.001 | 0.249 | 11 | 7294 | 0.002 | 0.499 | 11 | 7294 | 0.003 | 0.748 |
| 12:30 - 13:00 | 11 | 7294 | 0.001 | 0.249 | 11 | 7294 | 0.005 | 0.997 | 11 | 7294 | 0.006 | 1.246 |
| 13:00 - 13:30 | 11 | 7294 | 0.004 | 0.748 | 11 | 7294 | 0.001 | 0.249 | 11 | 7294 | 0.005 | 0.997 |
| 13:30 - 14:00 | 11 | 7294 | 0.001 | 0.249 | 11 | 7294 | 0.000 | 0.000 | 11 | 7294 | 0.001 | 0.249 |
| 14:00 - 14:30 | 11 | 7294 | 0.000 | 0.000 | 11 | 7294 | 0.002 | 0.499 | 11 | 7294 | 0.002 | 0.499 |
| 14:30 - 15:00 | 11 | 7294 | 0.000 | 0.000 | 11 | 7294 | 0.001 | 0.249 | 11 | 7294 | 0.001 | 0.249 |
| 15:00 - 15:30 | 11 | 7294 | 0.001 | 0.249 | 11 | 7294 | 0.004 | 0.748 | 11 | 7294 | 0.005 | 0.997 |
| 15:30 - 16:00 | 11 | 7294 | 0.000 | 0.000 | 11 | 7294 | 0.001 | 0.249 | 11 | 7294 | 0.001 | 0.249 |
| 16:00 - 16:30 | 11 | 7294 | 0.001 | 0.249 | 11 | 7294 | 0.002 | 0.499 | 11 | 7294 | 0.003 | 0.748 |
| 16:30 - 17:00 | 11 | 7294 | 0.000 | 0.000 | 11 | 7294 | 0.022 | 4.487 | 11 | 7294 | 0.022 | 4.487 |
| 17:00 - 17:30 | 11 | 7294 | 0.000 | 0.000 | 11 | 7294 | 0.010 | 1.994 | 11 | 7294 | 0.010 | 1.994 |
| 17:30 - 18:00 | 11 | 7294 | 0.000 | 0.000 | 11 | 7294 | 0.011 | 2.243 | 11 | 7294 | 0.011 | 2.243 |
| 18:00 - 18:30 | 11 | 7294 | 0.002 | 0.499 | 11 | 7294 | 0.002 | 0.499 | 11 | 7294 | 0.004 | 0.998 |
| 18:30 - 19:00 | 11 | 7294 | 0.000 | 0.000 | 11 | 7294 | 0.000 | 0.000 | 11 | 7294 | 0.000 | 0.000 |
| 19:00 - 19:30 | 0 | 0 | 0.000 | 0.000 | 0 | 0 | 0.000 | 0.000 | 0 | 0 | 0.000 | 0.000 |
| 19:30 - 20:00 | 0 | 0 | 0.000 | 0.000 | 0 | 0 | 0.000 | 0.000 | 0 | 0 | 0.000 | 0.000 |
| 20:00 - 20:30 | 0 | 0 | 0.000 | 0.000 | 0 | 0 | 0.000 | 0.000 | 0 | 0 | 0.000 | 0.000 |
| 20:30 - 21:00 | 0 | 0 | 0.000 | 0.000 | 0 | 0 | 0.000 | 0.000 | 0 | 0 | 0.000 | 0.000 |
| 21:00 - 21:30 | 0 | 0 | 0.000 | 0.000 | 0 | 0 | 0.000 | 0.000 | 0 | 0 | 0.000 | 0.000 |
| 21:30 - 22:00 | 0 | 0 | 0.000 | 0.000 | 0 | 0 | 0.000 | 0.000 | 0 | 0 | 0.000 | 0.000 |
| 22:00 - 22:30 | 0 | 0 | 0.000 | 0.000 | 0 | 0 | 0.000 | 0.000 | 0 | 0 | 0.000 | 0.000 |
| 22:30 - 23:00 | 0 | 0 | 0.000 | 0.000 | 0 | 0 | 0.000 | 0.000 | 0 | 0 | 0.000 | 0.000 |
| 23:00 - 23:30 | 0 | 0 | 0.000 | 0.000 | 0 | 0 | 0.000 | 0.000 | 0 | 0 | 0.000 | 0.000 |
| 23:30 - 24:00 | 0 | 0 | 0.000 | 0.000 | 0 | 0 | 0.000 | 0.000 | 0 | 0 | 0.000 | 0.000 |
| Total Rates: | | | 0.091 | 18.696 | | | 0.075 | 15.953 | | | 0.166 | 34.649 |

Parameter summary

| | |
|--|--------------------------|
| Trip rate parameter range selected: | 975 - 27142 (units: sqm) |
| Survey date date range: | 01/01/00 - 10/10/08 |
| Number of weekdays (Monday-Friday): | 11 |
| Number of Saturdays: | 0 |
| Number of Sundays: | 0 |
| Surveys manually removed from selection: | 0 |

TRIP RATE CALCULATION SELECTION PARAMETERS:

Land Use : 02 - EMPLOYMENT
 Category : B - BUSINESS PARK

MULTI-MODAL VEHICLES

Selected regions and areas:

| | | |
|--|--------------------|--------|
| 02 SOUTH EAST | | |
| BU | BUCKINGHAMSHIRE | 1 days |
| 03 SOUTH WEST | | |
| DC | DORSET | 1 days |
| WL | WILTSHIRE | 1 days |
| 04 EAST ANGLIA | | |
| SF | SUFFOLK | 1 days |
| 05 EAST MIDLANDS | | |
| LN | LINCOLNSHIRE | 1 days |
| NT | NOTTINGHAMSHIRE | 1 days |
| 06 WEST MIDLANDS | | |
| SH | SHROPSHIRE | 1 days |
| ST | STAFFORDSHIRE | 1 days |
| WO | WORCESTERSHIRE | 1 days |
| 07 YORKSHIRE & NORTH LINCOLNSHIRE | | |
| NO | NORTH LINCOLNSHIRE | 1 days |
| 09 NORTH | | |
| TW | TYNE & WEAR | 1 days |

Filtering Stage 2 selection:

Parameter: Gross floor area
 Range: 975 to 27142 (units: sqm)

Public Transport Provision:

Selection by: Include all surveys

Date Range: 01/01/00 to 10/10/08

Selected survey days:

| | |
|-----------|--------|
| Monday | 1 days |
| Tuesday | 3 days |
| Wednesday | 1 days |
| Thursday | 5 days |
| Friday | 1 days |

Selected survey types:

| | |
|-----------------------|---------|
| Manual count | 11 days |
| Directional ATC Count | 0 days |

Selected Locations:

| | |
|------------------------------------|---|
| Suburban Area (PPS6 Out of Centre) | 3 |
| Edge of Town | 8 |

Selected Location Sub Categories:

| | |
|------------------|---|
| Industrial Zone | 5 |
| Commercial Zone | 1 |
| Residential Zone | 2 |
| Built-Up Zone | 1 |
| No Sub Category | 2 |

TRIP RATE for Land Use 02 - EMPLOYMENT/B - BUSINESS PARK

MULTI-MODAL VEHICLES

Calculation factor: 100 sqm

Estimated TRIP rate value per 20000 SQM shown in shaded columns

BOLD print indicates peak (busiest) period

| Time Range | ARRIVALS | | | | DEPARTURES | | | | TOTALS | | | |
|---------------------|-----------|-------------|--------------|---------------------|------------|-------------|--------------|---------------------|-----------|-------------|---------------|---------------------|
| | No. Days | Ave. GFA | Trip Rate | Estimated Trip Rate | No. Days | Ave. GFA | Trip Rate | Estimated Trip Rate | No. Days | Ave. GFA | Trip Rate | Estimated Trip Rate |
| 00:00 - 00:30 | 0 | 0 | 0.000 | 0.000 | 0 | 0 | 0.000 | 0.000 | 0 | 0 | 0.000 | 0.000 |
| 00:30 - 01:00 | 0 | 0 | 0.000 | 0.000 | 0 | 0 | 0.000 | 0.000 | 0 | 0 | 0.000 | 0.000 |
| 01:00 - 01:30 | 0 | 0 | 0.000 | 0.000 | 0 | 0 | 0.000 | 0.000 | 0 | 0 | 0.000 | 0.000 |
| 01:30 - 02:00 | 0 | 0 | 0.000 | 0.000 | 0 | 0 | 0.000 | 0.000 | 0 | 0 | 0.000 | 0.000 |
| 02:00 - 02:30 | 0 | 0 | 0.000 | 0.000 | 0 | 0 | 0.000 | 0.000 | 0 | 0 | 0.000 | 0.000 |
| 02:30 - 03:00 | 0 | 0 | 0.000 | 0.000 | 0 | 0 | 0.000 | 0.000 | 0 | 0 | 0.000 | 0.000 |
| 03:00 - 03:30 | 0 | 0 | 0.000 | 0.000 | 0 | 0 | 0.000 | 0.000 | 0 | 0 | 0.000 | 0.000 |
| 03:30 - 04:00 | 0 | 0 | 0.000 | 0.000 | 0 | 0 | 0.000 | 0.000 | 0 | 0 | 0.000 | 0.000 |
| 04:00 - 04:30 | 0 | 0 | 0.000 | 0.000 | 0 | 0 | 0.000 | 0.000 | 0 | 0 | 0.000 | 0.000 |
| 04:30 - 05:00 | 0 | 0 | 0.000 | 0.000 | 0 | 0 | 0.000 | 0.000 | 0 | 0 | 0.000 | 0.000 |
| 05:00 - 05:30 | 0 | 0 | 0.000 | 0.000 | 0 | 0 | 0.000 | 0.000 | 0 | 0 | 0.000 | 0.000 |
| 05:30 - 06:00 | 0 | 0 | 0.000 | 0.000 | 0 | 0 | 0.000 | 0.000 | 0 | 0 | 0.000 | 0.000 |
| 06:00 - 06:30 | 0 | 0 | 0.000 | 0.000 | 0 | 0 | 0.000 | 0.000 | 0 | 0 | 0.000 | 0.000 |
| 06:30 - 07:00 | 0 | 0 | 0.000 | 0.000 | 0 | 0 | 0.000 | 0.000 | 0 | 0 | 0.000 | 0.000 |
| 07:00 - 07:30 | 11 | 7294 | 0.122 | 24.429 | 11 | 7294 | 0.042 | 8.475 | 11 | 7294 | 0.164 | 32.904 |
| 07:30 - 08:00 | 11 | 7294 | 0.312 | 62.318 | 11 | 7294 | 0.066 | 13.212 | 11 | 7294 | 0.378 | 75.530 |
| 08:00 - 08:30 | 11 | 7294 | 0.546 | 109.182 | 11 | 7294 | 0.145 | 28.916 | 11 | 7294 | 0.691 | 138.098 |
| 08:30 - 09:00 | 11 | 7294 | 0.818 | 163.524 | 11 | 7294 | 0.141 | 28.168 | 11 | 7294 | 0.959 | 191.692 |
| 09:00 - 09:30 | 11 | 7294 | 0.532 | 106.440 | 11 | 7294 | 0.173 | 34.649 | 11 | 7294 | 0.705 | 141.089 |
| 09:30 - 10:00 | 11 | 7294 | 0.290 | 58.081 | 11 | 7294 | 0.155 | 30.910 | 11 | 7294 | 0.445 | 88.991 |
| 10:00 - 10:30 | 11 | 7294 | 0.213 | 42.626 | 11 | 7294 | 0.173 | 34.649 | 11 | 7294 | 0.386 | 77.275 |
| 10:30 - 11:00 | 11 | 7294 | 0.156 | 31.159 | 11 | 7294 | 0.158 | 31.658 | 11 | 7294 | 0.314 | 62.817 |
| 11:00 - 11:30 | 11 | 7294 | 0.165 | 32.904 | 11 | 7294 | 0.206 | 41.130 | 11 | 7294 | 0.371 | 74.034 |
| 11:30 - 12:00 | 11 | 7294 | 0.163 | 32.655 | 11 | 7294 | 0.199 | 39.884 | 11 | 7294 | 0.362 | 72.539 |
| 12:00 - 12:30 | 11 | 7294 | 0.182 | 36.394 | 11 | 7294 | 0.375 | 75.031 | 11 | 7294 | 0.557 | 111.425 |
| 12:30 - 13:00 | 11 | 7294 | 0.228 | 45.617 | 11 | 7294 | 0.277 | 55.339 | 11 | 7294 | 0.505 | 100.956 |
| 13:00 - 13:30 | 11 | 7294 | 0.350 | 70.046 | 11 | 7294 | 0.315 | 63.066 | 11 | 7294 | 0.665 | 133.112 |
| 13:30 - 14:00 | 11 | 7294 | 0.328 | 65.559 | 11 | 7294 | 0.238 | 47.611 | 11 | 7294 | 0.566 | 113.170 |
| 14:00 - 14:30 | 11 | 7294 | 0.184 | 36.893 | 11 | 7294 | 0.138 | 27.669 | 11 | 7294 | 0.322 | 64.562 |
| 14:30 - 15:00 | 11 | 7294 | 0.183 | 36.643 | 11 | 7294 | 0.213 | 42.626 | 11 | 7294 | 0.396 | 79.269 |
| 15:00 - 15:30 | 11 | 7294 | 0.181 | 36.145 | 11 | 7294 | 0.259 | 51.849 | 11 | 7294 | 0.440 | 87.994 |
| 15:30 - 16:00 | 11 | 7294 | 0.177 | 35.397 | 11 | 7294 | 0.242 | 48.359 | 11 | 7294 | 0.419 | 83.756 |
| 16:00 - 16:30 | 11 | 7294 | 0.152 | 30.411 | 11 | 7294 | 0.304 | 60.823 | 11 | 7294 | 0.456 | 91.234 |
| 16:30 - 17:00 | 11 | 7294 | 0.116 | 23.182 | 11 | 7294 | 0.401 | 80.266 | 11 | 7294 | 0.517 | 103.448 |
| 17:00 - 17:30 | 11 | 7294 | 0.156 | 31.159 | 11 | 7294 | 0.653 | 130.620 | 11 | 7294 | 0.809 | 161.779 |
| 17:30 - 18:00 | 11 | 7294 | 0.079 | 15.704 | 11 | 7294 | 0.533 | 106.689 | 11 | 7294 | 0.612 | 122.393 |
| 18:00 - 18:30 | 11 | 7294 | 0.042 | 8.475 | 11 | 7294 | 0.231 | 46.116 | 11 | 7294 | 0.273 | 54.591 |
| 18:30 - 19:00 | 11 | 7294 | 0.021 | 4.238 | 11 | 7294 | 0.103 | 20.690 | 11 | 7294 | 0.124 | 24.928 |
| 19:00 - 19:30 | 0 | 0 | 0.000 | 0.000 | 0 | 0 | 0.000 | 0.000 | 0 | 0 | 0.000 | 0.000 |
| 19:30 - 20:00 | 0 | 0 | 0.000 | 0.000 | 0 | 0 | 0.000 | 0.000 | 0 | 0 | 0.000 | 0.000 |
| 20:00 - 20:30 | 0 | 0 | 0.000 | 0.000 | 0 | 0 | 0.000 | 0.000 | 0 | 0 | 0.000 | 0.000 |
| 20:30 - 21:00 | 0 | 0 | 0.000 | 0.000 | 0 | 0 | 0.000 | 0.000 | 0 | 0 | 0.000 | 0.000 |
| 21:00 - 21:30 | 0 | 0 | 0.000 | 0.000 | 0 | 0 | 0.000 | 0.000 | 0 | 0 | 0.000 | 0.000 |
| 21:30 - 22:00 | 0 | 0 | 0.000 | 0.000 | 0 | 0 | 0.000 | 0.000 | 0 | 0 | 0.000 | 0.000 |
| 22:00 - 22:30 | 0 | 0 | 0.000 | 0.000 | 0 | 0 | 0.000 | 0.000 | 0 | 0 | 0.000 | 0.000 |
| 22:30 - 23:00 | 0 | 0 | 0.000 | 0.000 | 0 | 0 | 0.000 | 0.000 | 0 | 0 | 0.000 | 0.000 |
| 23:00 - 23:30 | 0 | 0 | 0.000 | 0.000 | 0 | 0 | 0.000 | 0.000 | 0 | 0 | 0.000 | 0.000 |
| 23:30 - 24:00 | 0 | 0 | 0.000 | 0.000 | 0 | 0 | 0.000 | 0.000 | 0 | 0 | 0.000 | 0.000 |
| Total Rates: | | | 5.696 | 1139.181 | | | 5.740 | 1148.405 | | | 11.436 | 2287.586 |

Parameter summary

| | |
|--|--------------------------|
| Trip rate parameter range selected: | 975 - 27142 (units: sqm) |
| Survey date date range: | 01/01/00 - 10/10/08 |
| Number of weekdays (Monday-Friday): | 11 |
| Number of Saturdays: | 0 |
| Number of Sundays: | 0 |
| Surveys manually removed from selection: | 0 |

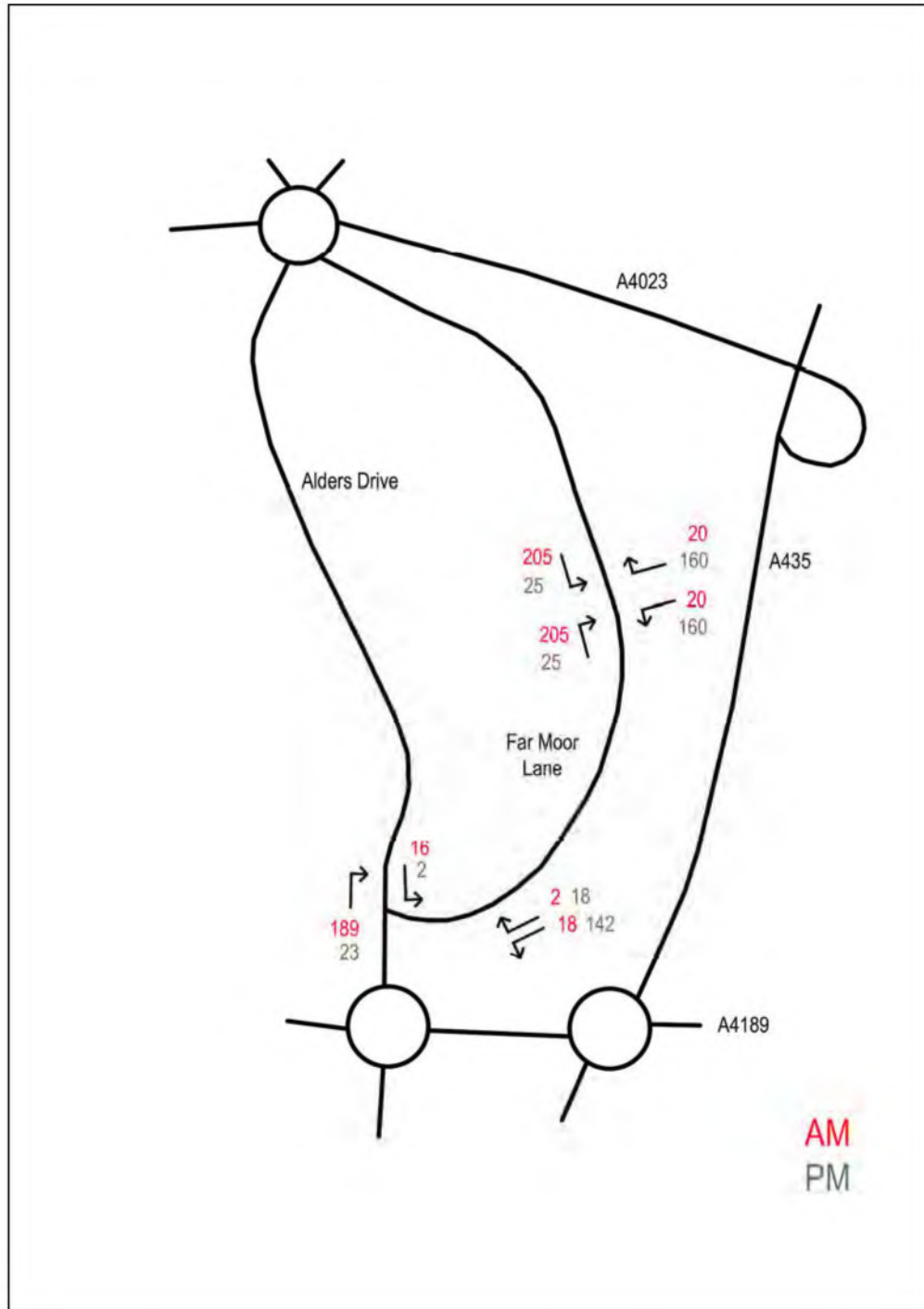

AM
PM

| | | | | | | |
|---|------------------------|---|--|---|-----------|------|
| Reproduced by permission of Ordnance Survey on behalf of HMSO © Crown Copyright 2006. All rights reserved. Ordnance Survey Licence number 100046211 | | DO NOT SCALE. USE FIGURED DIMENSIONS ONLY. CHECK ON SITE AND REPORT ANY DISCREPANCIES TO MORGAN TUCKER. | | Rev | Amendment | Date |
| Client Redditch Borough Council | Drawn By TS | Checked By LB | Approved By BS | | | |
| Project Title Proposed Diversification Park Development | Date 28/09/09 | Scale NTS | | | | |
| Drawing Title Development Trip Assignment Business Innovation Centre 20000sqm | Purpose Information | | Drawing Number JN835 - NWK - 006 | | | |
| Copyright © Morgan Tucker | | | | AURA Commerce and Technology Centre, Manners Road Newark, Nottinghamshire, NG24 1BS Tel:- 01636 610 766 Fax:- 01636 610 786 E-Mail:- info@morgantucker.co.uk www.morgantucker.co.uk | | |

A435

20
166

205
26

20
154

205
24

AM
PM

Reproduced by permission of Ordnance Survey on behalf of
HMSO © Crown Copyright 2006. All rights reserved.
Ordnance Survey Licence number 100046211

DO NOT SCALE. USE FIGURED DIMENSIONS ONLY.
CHECK ON SITE AND REPORT ALL DISCREPANCIES TO
MORGAN TUCKER.

Copyright © Morgan Tucker

Client
Redditch Borough Council

Drawn By
CR

Checked By
VRG

Approved By
BS

Date
08/10/09

Scale
NTS

Project Title
Proposed Diversification Park Development

Purpose
Information

Drawing Title
Development Trip Assignment
Business Innovation Centre 20000sqm

Drawing Number
JN835 - NWK - 007

Licence number



AURA Commerce and Technology Centre, Manners Road
Newark, Nottinghamshire, NG24 1BS

Tel:- 01636 610 766 Fax:- 01636 610 786

E-Mail :- info@morgantucker.co.uk

www.morgantucker.co.uk

213
27

197
23

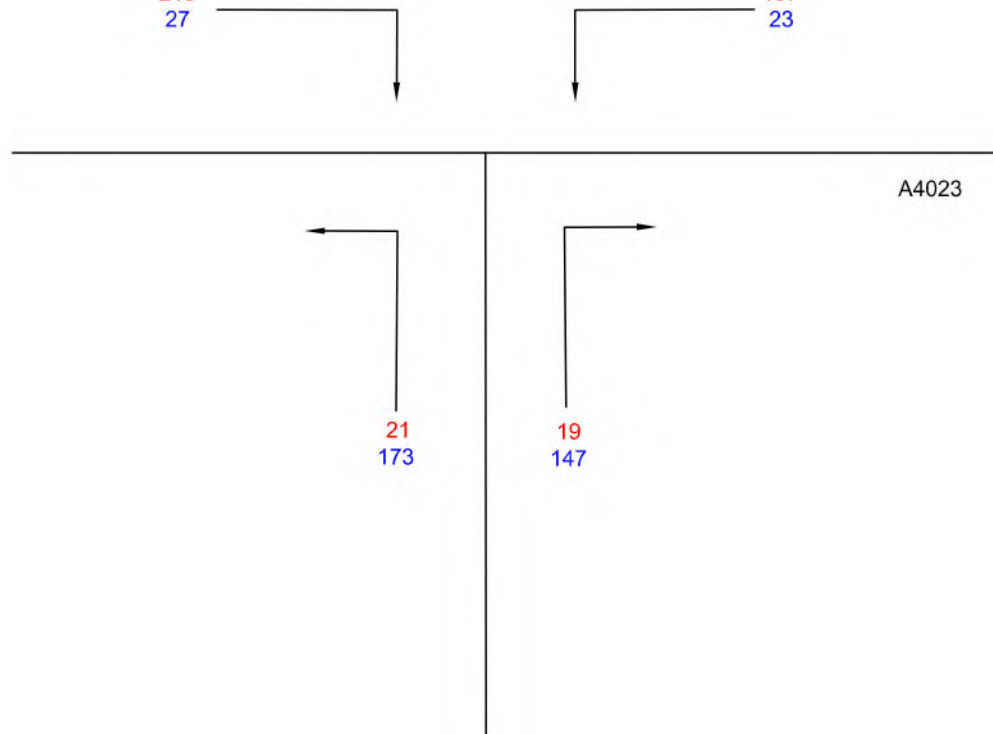

A4023

AM
PM

| | | | | | |
|---|--|---|-------------------|---------------------------|--|
| Reproduced by permission of Ordnance Survey on behalf of HMSO © Crown Copyright 2006. All rights reserved. Ordnance Survey Licence number 100046211 | | DO NOT SCALE. USE FIGURED DIMENSIONS ONLY. CHECK ON SITE AND REPORT ALL DISCREPANCIES TO MORGAN TUCKER. | | Copyright © Morgan Tucker | |
| Client Redditch Borough Council | | Drawn By CR | Checked By VRG | Approved By BS | |
| | | Date 08/10/09 | Scale NTS | | |
| Project Title Proposed Diversification Park Development | | Purpose Information | | | |
| Drawing Title Development Trip Assignment Business Innovation Centre 20000sqm | | Drawing Number JN835 - NWK - 008 | | Licence number | |



AURA Commerce and Technology Centre, Manners Road
 Newark, Nottinghamshire, NG24 1BS
 Tel:- 01636 610 766 Fax:- 01636 610 786
 E-Mail :- info@morgantucker.co.uk
 www.morgantucker.co.uk

APPENDIX G

Traffic Distribution Diagrams

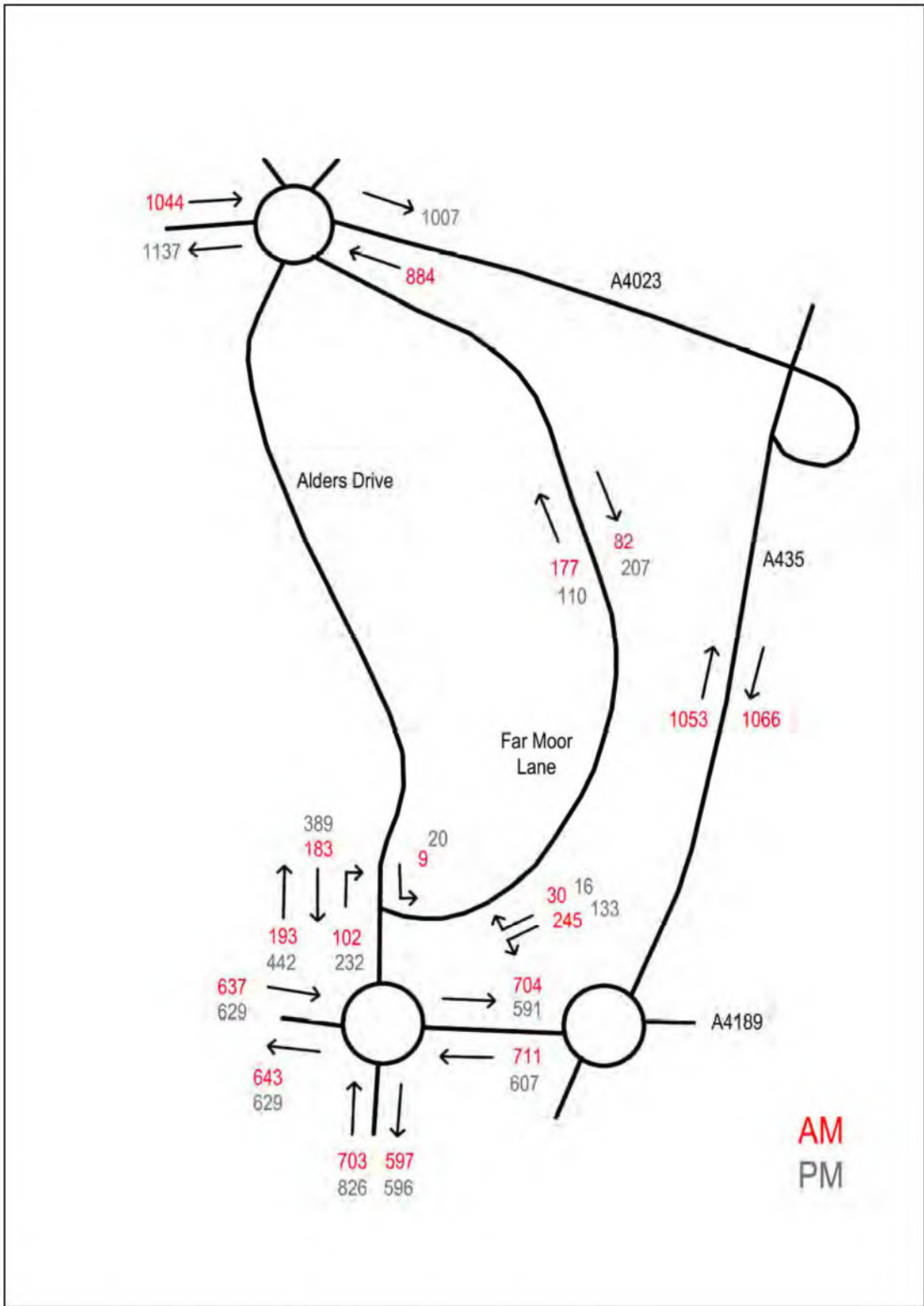

| | | | | | | |
|---|------------------------|---|--|--|-----------|------|
| Reproduced by permission of Ordnance Survey on behalf of HMSO © Crown Copyright 2006. All rights reserved. Ordnance Survey Licence number 100046211 | | DO NOT SCALE. USE FIGURED DIMENSIONS ONLY. CHECK ON SITE AND REPORT ANY DISCREPANCIES TO MORGAN TUCKER. | | Rev | Amendment | Date |
| Client Redditch Borough Council | Drawn By TS | Checked By LB | Approved By BS |  AURA Commerce and Technology Centre, Manners Road Newark, Nottinghamshire, NG24 1BS Tel:- 01636 610 766 Fax:- 01636 610 786 E-Mail:- info@morgantucker.co.uk www.morgantucker.co.uk | | |
| Project Title Proposed Diversification Park Development | Date 28/09/09 | Scale NTS | | | | |
| Drawing Title 2012 Without Development Traffic Flow Distribution | Purpose Information | | Drawing Number JN835 - NWK - 009 | | | |
| Copyright © Morgan Tucker | | | | | | |

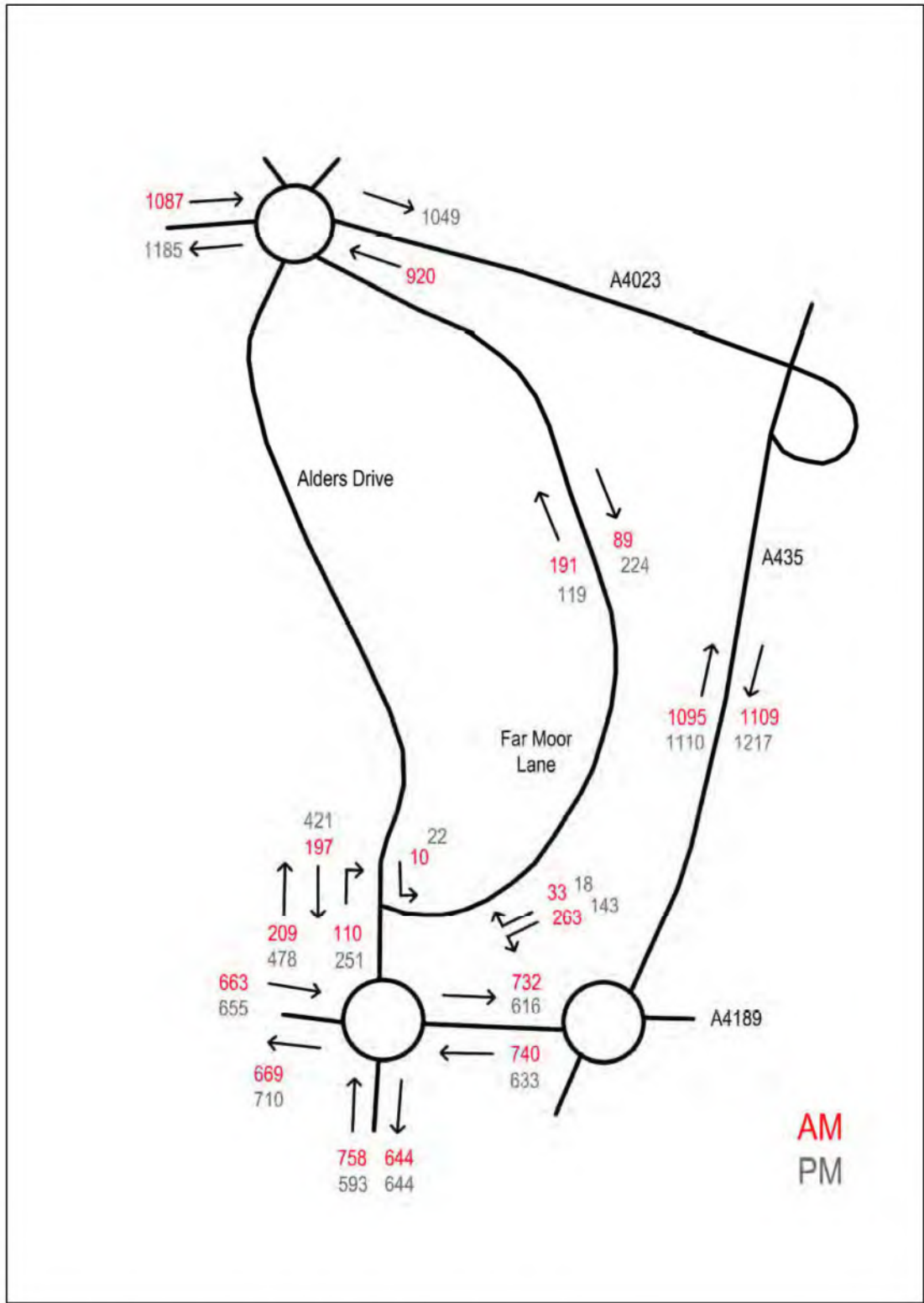

| | | | | | | |
|---|--|---|------------------------|--|-----------|------|
| Reproduced by permission of Ordnance Survey on behalf of HMSO © Crown Copyright 2006. All rights reserved. Ordnance Survey Licence number 100046211 | | DO NOT SCALE. USE FIGURED DIMENSIONS ONLY. CHECK ON SITE AND REPORT ANY DISCREPANCIES TO MORGAN TUCKER. | | Rev | Amendment | Date |
| Client Redditch Borough Council | Drawn By TS | Checked By LB | Approved By BS |  <p>AURA Commerce and Technology Centre, Manners Road Newark, Nottinghamshire, NG24 1BS Tel:- 01636 610 766 Fax:- 01636 610 786 E-Mail:- info@morgantucker.co.uk www.morgantucker.co.uk</p> | | |
| Project Title Proposed Diversification Park Development | Date 28/09/09 | Scale NTS | Purpose Information | | | |
| Drawing Title 2017 Without Development Traffic Flow Distribution | Drawing Number JN835 - NWK - 010 | | Rev | | | |
| Copyright © Morgan Tucker | | | | | | |

APPENDIX H

ARCADY and PICADY Outputs
Development Site Access Options
LinSig Outputs

| PICADY | | |
|---|---|---|
| GUI Version: 5.00 AC Analysis Program Release: 3.0 INTERIM (MAR 2006) | | |
| © Copyright TRL Limited, 2006 Adapted from PICADY/3 which is Crown Copyright by permission of the controller of HMSO | | |
| For sales and distribution information, program advice and maintenance, contact: | | |
| TRL Limited Crowthorne House Nine Mile Ride Wokingham, Berks. RG40 3GA, UK |  | Tel: +44 (0)1344 770758 Fax: +44 (0)1344 770864 E-mail: softwarebureau@trl.co.uk Web: www.trlsoftware.co.uk |
| The user of this computer program for the solution of an engineering problem is in no way relieved of their responsibility for the correctness of the solution | | |

Run Analysis

| Parameter | Values |
|--------------|--|
| File Run | G:\..\Far Moor Lane Alders Drive T junction\2009 AM Peak.vpi |
| Date Run | 23 September 2009 |
| Time Run | 12:25:39 |
| Driving Side | Drive On The Left |

Arm Names and Flow Scaling Factors

| Arm | Arm Name | Flow Scaling Factor (%) |
|-------|--------------------|-------------------------|
| Arm A | Alders Drive North | 100 |
| Arm B | Far Moor Lane | 100 |
| Arm C | Alders Drive South | 100 |

Stream Labelling Convention

Stream A-B contains traffic going from A to B etc.

Run Information

| Parameter | Values |
|-------------|----------------------------------|
| Run Title | 2009 Far Moor Lane_ Alders Drive |
| Location | Redditch |
| Date | 23 September 2009 |
| Enumerator | lbates [HP24852250691] |
| Job Number | 835 |
| Status | Preliminary |
| Client | Redditch Borough Council |
| Description | - |

Errors and Warnings

| Parameter | Values |
|-----------|-----------------------|
| Warning | No Errors Or Warnings |

Geometric Data

Geometric Parameters

| Parameter | Minor Arm B |
|---|-------------|
| Major Road Carriageway Width (m) | 8.30 |
| Major Road Kerbed Central Reserve Width (m) | 0.00 |
| Major Road Right Turning Lane Width (m) | 2.20 |
| Minor Road Width 0m Back from Junction (m) | 10.00 |
| Minor Road Width 5m Back from Junction (m) | 6.50 |
| Minor Road Width 10m Back from Junction (m) | 5.25 |
| Minor Road Width 15m Back from Junction (m) | 4.50 |
| Minor Road Width 20m Back from Junction (m) | 4.00 |
| Minor Road Flare Length (veh) | 1 |
| Minor Road Visibility To Right (m) | 27 |
| Minor Road Visibility To Left (m) | 27 |
| Major Road Right Turn Visibility (m) | 50 |
| Major Road Right Turn Blocks Traffic | No |

Slope and Intercept Values

| Stream | Intercept for Stream B-A | Slope for A-B | Slope for A-C | Slope for C-A | Slope for C-B |
|--------|--------------------------|---------------|---------------|---------------|---------------|
| B-A | 459.592 | 0.075 | 0.190 | 0.120 | 0.272 |
| B-C | 589.599 | 0.081 | 0.206 | - | - |
| C-B | 602.919 | 0.210 | 0.210 | - | - |

Note: Streams may be combined in which case capacity will be adjusted
These values do not allow for any site-specific corrections

Junction Diagram



Demand Data

Modelling Periods

| Parameter | Period | Duration (min) | Segment Length (min) |
|------------------------|-------------|----------------|----------------------|
| First Modelling Period | 07:45-09:15 | 90 | 15 |

ODTAB Turning Counts

Demand Set: 2009 Far Moor Lane_ Alders Drive
Modelling Period: 07:45-09:15

| From/To | Arm A | Arm B | Arm C |
|---------|-------|-------|-------|
| Arm A | 0.0 | 9.0 | 176.0 |
| Arm B | 29.0 | 0.0 | 235.0 |
| Arm C | 186.0 | 98.0 | 0.0 |

ODTAB Synthesised Flows

Demand Set: 2009 Far Moor Lane_ Alders Drive

Modelling Period: 07:45-09:15

| Arm | Rising Time | Rising Flow (veh/min) | Peak Time | Peak Flow (veh/min) | Falling Time | Falling Flow (veh/min) |
|-------|-------------|-----------------------|-----------|---------------------|--------------|------------------------|
| Arm A | 08:00 | 2.313 | 08:00 | 3.469 | 08:30 | 2.313 |
| Arm B | 08:00 | 3.300 | 08:00 | 4.950 | 08:30 | 3.300 |
| Arm C | 08:00 | 3.550 | 08:00 | 5.325 | 08:30 | 3.550 |

Heavy Vehicles Percentages

Demand Set: 2009 Far Moor Lane_ Alders Drive

Modelling Period: 07:45-09:15

| From/To | Arm A | Arm B | Arm C |
|---------|-------|-------|-------|
| Arm A | - | 10.0 | 10.0 |
| Arm B | 10.0 | - | 10.0 |
| Arm C | 10.0 | 10.0 | - |

Default proportions of heavy vehicles are used

Queue Diagrams

Demand Set: Sum of Demand Sets for Modelling Period: 07:45 - 09:15

Modelling Period: 07:45-09:15

View Extent: 40m

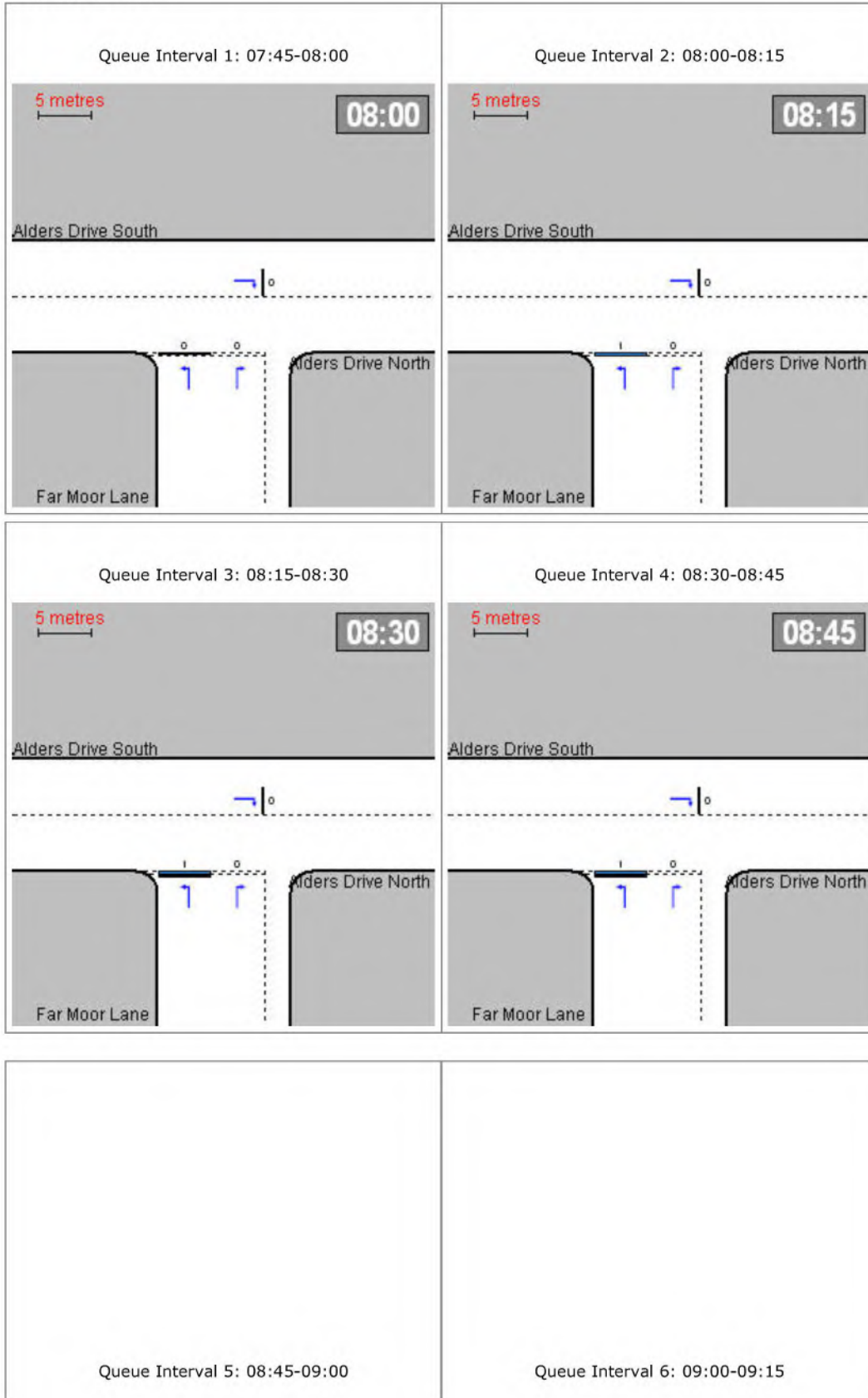

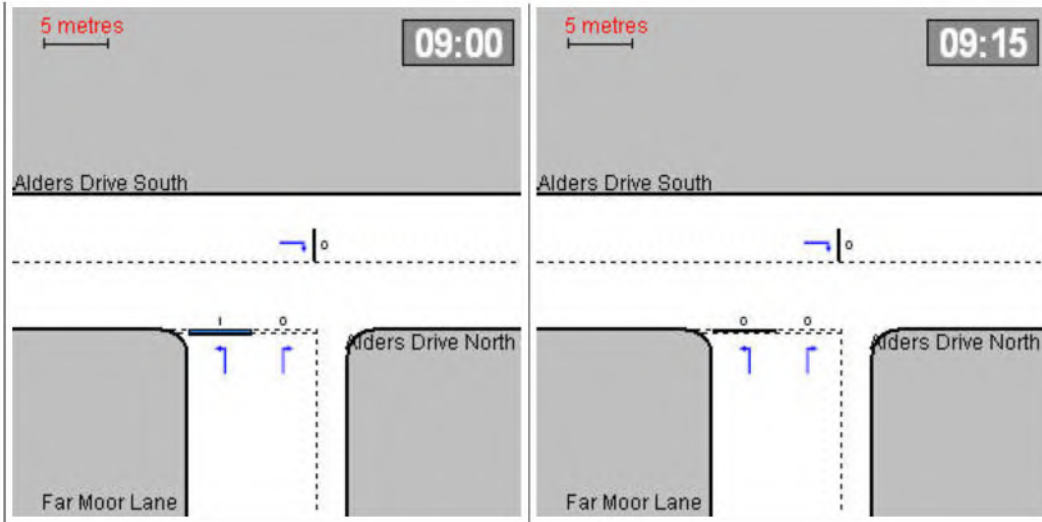

Capacity Graph

Demand Set: Sum of Demand Sets for Modelling Period: 07:45 - 09:15
Modelling Period: 07:45-09:15

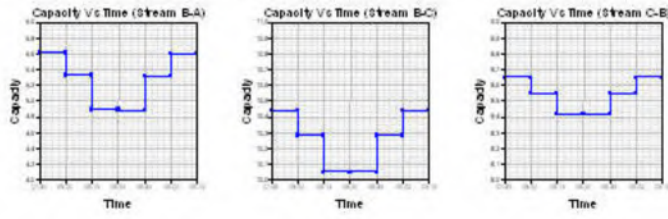

RFC Graph

Demand Set: Sum of Demand Sets for Modelling Period: 07:45 - 09:15
Modelling Period: 07:45-09:15

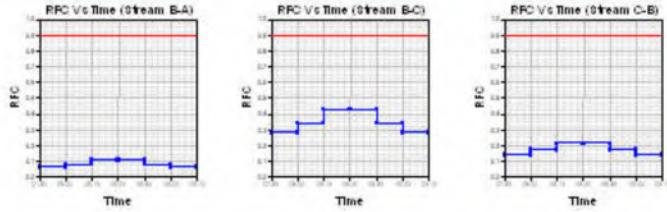

Start Queue Graph

Demand Set: Sum of Demand Sets for Modelling Period: 07:45 - 09:15
Modelling Period: 07:45-09:15

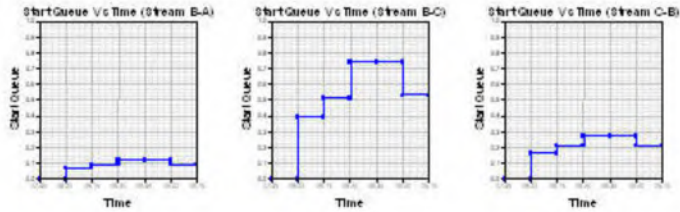

End Queue Graph

Demand Set: Sum of Demand Sets for Modelling Period: 07:45 - 09:15
Modelling Period: 07:45-09:15

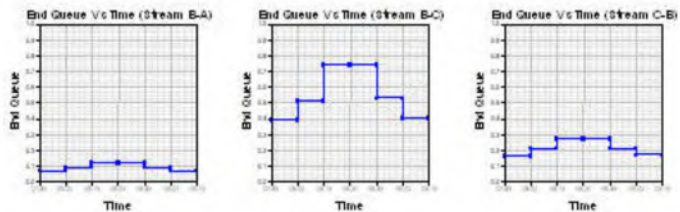

Delay Graph

Demand Set: Sum of Demand Sets for Modelling Period: 07:45 - 09:15
Modelling Period: 07:45-09:15



Queues & Delays

Demand Set: Sum of Demand Sets for Modelling Period: 07:45 - 09:15

Modelling Period: 07:45-09:15

| Segment | Stream | Demand (veh/min) | Capacity (veh/min) | RFC | Ped. Flow (ped/min) | Start Queue (veh) | End Queue (veh) | Geometric Delay (veh.min/segment) | Delay (veh.min/segment) | Mean Arriving Vehicle Delay (min) |
|-------------|--------|------------------|--------------------|-------|---------------------|-------------------|-----------------|-----------------------------------|-------------------------|-----------------------------------|
| 07:45-08:00 | B-A | 0.36 | 5.61 | 0.065 | - | 0.00 | 0.07 | - | 1.0 | 0.19 |
| | B-C | 2.95 | 10.44 | 0.282 | - | 0.00 | 0.39 | - | 5.6 | 0.13 |
| | C-A | 2.33 | - | - | - | - | - | - | - | - |
| | C-B | 1.23 | 8.65 | 0.142 | - | 0.00 | 0.16 | - | 2.4 | 0.13 |
| | A-B | 0.11 | - | - | - | - | - | - | - | - |
| | A-C | 2.21 | - | - | - | - | - | - | - | - |
| Segment | Stream | Demand (veh/min) | Capacity (veh/min) | RFC | Ped. Flow (ped/min) | Start Queue (veh) | End Queue (veh) | Geometric Delay (veh.min/segment) | Delay (veh.min/segment) | Mean Arriving Vehicle Delay (min) |
| 08:00-08:15 | B-A | 0.43 | 5.33 | 0.082 | - | 0.07 | 0.09 | - | 1.3 | 0.20 |
| | B-C | 3.52 | 10.28 | 0.342 | - | 0.39 | 0.51 | - | 7.5 | 0.15 |
| | C-A | 2.79 | - | - | - | - | - | - | - | - |
| | C-B | 1.47 | 8.55 | 0.172 | - | 0.16 | 0.21 | - | 3.0 | 0.14 |
| | A-B | 0.13 | - | - | - | - | - | - | - | - |
| | A-C | 2.64 | - | - | - | - | - | - | - | - |
| Segment | Stream | Demand (veh/min) | Capacity (veh/min) | RFC | Ped. Flow (ped/min) | Start Queue (veh) | End Queue (veh) | Geometric Delay (veh.min/segment) | Delay (veh.min/segment) | Mean Arriving Vehicle Delay (min) |
| 08:15-08:30 | B-A | 0.53 | 4.89 | 0.109 | - | 0.09 | 0.12 | - | 1.7 | 0.23 |
| | B-C | 4.31 | 10.05 | 0.429 | - | 0.51 | 0.74 | - | 10.6 | 0.17 |
| | C-A | 3.41 | - | - | - | - | - | - | - | - |
| | C-B | 1.80 | 8.42 | 0.214 | - | 0.21 | 0.27 | - | 3.9 | 0.15 |
| | A-B | 0.17 | - | - | - | - | - | - | - | - |
| | A-C | 3.23 | - | - | - | - | - | - | - | - |
| Segment | Stream | Demand (veh/min) | Capacity (veh/min) | RFC | Ped. Flow (ped/min) | Start Queue (veh) | End Queue (veh) | Geometric Delay (veh.min/segment) | Delay (veh.min/segment) | Mean Arriving Vehicle Delay (min) |
| 08:30-08:45 | B-A | 0.53 | 4.88 | 0.109 | - | 0.12 | 0.12 | - | 1.8 | 0.23 |
| | B-C | 4.31 | 10.05 | 0.429 | - | 0.74 | 0.74 | - | 11.1 | 0.17 |
| | C-A | 3.41 | - | - | - | - | - | - | - | - |
| | C-B | 1.80 | 8.42 | 0.214 | - | 0.27 | 0.27 | - | 4.0 | 0.15 |
| | A-B | 0.17 | - | - | - | - | - | - | - | - |
| | A-C | 3.23 | - | - | - | - | - | - | - | - |

| Segment | Stream | Demand (veh/min) | Capacity (veh/min) | RFC | Ped. Flow (ped/min) | Start Queue (veh) | End Queue (veh) | Geometric Delay (veh.min/segment) | Delay (veh.min/segment) | Mean Arriving Vehicle Delay (min) |
|-------------|--------|------------------|--------------------|-------|---------------------|-------------------|-----------------|-----------------------------------|-------------------------|-----------------------------------|
| 08:45-09:00 | B-A | 0.43 | 5.32 | 0.082 | - | 0.12 | 0.09 | - | 1.4 | 0.20 |
| | B-C | 3.52 | 10.28 | 0.343 | - | 0.74 | 0.53 | - | 8.2 | 0.15 |
| | C-A | 2.79 | - | - | - | - | - | - | - | - |
| | C-B | 1.47 | 8.55 | 0.172 | - | 0.27 | 0.21 | - | 3.2 | 0.14 |
| | A-B | 0.13 | - | - | - | - | - | - | - | - |
| | A-C | 2.64 | - | - | - | - | - | - | - | - |
| Segment | Stream | Demand (veh/min) | Capacity (veh/min) | RFC | Ped. Flow (ped/min) | Start Queue (veh) | End Queue (veh) | Geometric Delay (veh.min/segment) | Delay (veh.min/segment) | Mean Arriving Vehicle Delay (min) |
| 09:00-09:15 | B-A | 0.36 | 5.60 | 0.065 | - | 0.09 | 0.07 | - | 1.1 | 0.19 |
| | B-C | 2.95 | 10.44 | 0.282 | - | 0.53 | 0.40 | - | 6.1 | 0.13 |
| | C-A | 2.33 | - | - | - | - | - | - | - | - |
| | C-B | 1.23 | 8.65 | 0.142 | - | 0.21 | 0.17 | - | 2.6 | 0.13 |
| | A-B | 0.11 | - | - | - | - | - | - | - | - |
| | A-C | 2.21 | - | - | - | - | - | - | - | - |

Entry capacities marked with an '(X)' are dominated by a pedestrian crossing in that time segment.

In time segments marked with a '(B)', traffic leaving the junction may block back from a crossing so impairing normal operation of the junction.

Delays marked with '# #' could not be calculated.

Overall Queues & Delays

Queueing Delay Information Over Whole Period

Demand Set: Sum of Demand Sets for Modelling Period: 07:45 - 09:15

Modelling Period: 07:45-09:15

| Stream | Total Demand (veh) | Total Demand (veh/h) | Queueing Delay (min) | Queueing Delay (min/veh) | Inclusive Delay (min) | Inclusive Delay (min/veh) |
|------------|--------------------|----------------------|----------------------|--------------------------|-----------------------|---------------------------|
| B-A | 39.9 | 26.6 | 8.3 | 0.2 | 8.3 | 0.2 |
| B-C | 323.5 | 215.6 | 49.2 | 0.2 | 49.2 | 0.2 |
| C-A | 256.0 | 170.7 | - | - | - | - |
| C-B | 134.9 | 89.9 | 19.1 | 0.1 | 19.1 | 0.1 |
| A-B | 12.4 | 8.3 | - | - | - | - |
| A-C | 242.3 | 161.5 | - | - | - | - |
| All | 1008.9 | 672.6 | 76.6 | 0.1 | 76.6 | 0.1 |

Delay is that occurring only within the time period.

Inclusive delay includes delay suffered by vehicles which are still queuing after the end of the time period.

These will only be significantly different if there is a large queue remaining at the end of the time period.

PICADY 5 Run Successful

| PICADY | | |
|---|---|---|
| GUI Version: 5.00 AC Analysis Program Release: 3.0 INTERIM (MAR 2006) | | |
| © Copyright TRL Limited, 2006 Adapted from PICADY/3 which is Crown Copyright by permission of the controller of HMSO | | |
| For sales and distribution information, program advice and maintenance, contact: | | |
| TRL Limited Crowthorne House Nine Mile Ride Wokingham, Berks. RG40 3GA, UK |  | Tel: +44 (0)1344 770758 Fax: +44 (0)1344 770864 E-mail: softwarebureau@trl.co.uk Web: www.trlsoftware.co.uk |
| The user of this computer program for the solution of an engineering problem is in no way relieved of their responsibility for the correctness of the solution | | |

Run Analysis

| Parameter | Values |
|--------------|--|
| File Run | G:\..\Far Moor Lane Alders Drive T junction\2009 PM Peak.vpi |
| Date Run | 23 September 2009 |
| Time Run | 12:27:49 |
| Driving Side | Drive On The Left |

Arm Names and Flow Scaling Factors

| Arm | Arm Name | Flow Scaling Factor (%) |
|-------|--------------------|-------------------------|
| Arm A | Alders Drive North | 100 |
| Arm B | Far Moor Lane | 100 |
| Arm C | Alders Drive South | 100 |

Stream Labelling Convention

Stream A-B contains traffic going from A to B etc.

Run Information

| Parameter | Values |
|-------------|--|
| Run Title | 2009 Far Moor Lane_ Alders Drive PM Peak |
| Location | Redditch |
| Date | 23 September 2009 |
| Enumerator | lbates [HP24852250691] |
| Job Number | 835 |
| Status | Preliminary |
| Client | Redditch Borough Council |
| Description | - |

Errors and Warnings

| Parameter | Values |
|-----------|-----------------------|
| Warning | No Errors Or Warnings |

Geometric Data

Geometric Parameters

| Parameter | Minor Arm B |
|---|-------------|
| Major Road Carriageway Width (m) | 8.30 |
| Major Road Kerbed Central Reserve Width (m) | 0.00 |
| Major Road Right Turning Lane Width (m) | 2.20 |
| Minor Road Width 0m Back from Junction (m) | 10.00 |
| Minor Road Width 5m Back from Junction (m) | 6.50 |
| Minor Road Width 10m Back from Junction (m) | 5.25 |
| Minor Road Width 15m Back from Junction (m) | 4.50 |
| Minor Road Width 20m Back from Junction (m) | 4.00 |
| Minor Road Flare Length (veh) | 1 |
| Minor Road Visibility To Right (m) | 27 |
| Minor Road Visibility To Left (m) | 27 |
| Major Road Right Turn Visibility (m) | 50 |
| Major Road Right Turn Blocks Traffic | No |

Slope and Intercept Values

| Stream | Intercept for Stream B-A | Slope for A-B | Slope for A-C | Slope for C-A | Slope for C-B |
|--------|--------------------------|---------------|---------------|---------------|---------------|
| B-A | 459.592 | 0.075 | 0.190 | 0.120 | 0.272 |
| B-C | 589.599 | 0.081 | 0.206 | - | - |
| C-B | 602.919 | 0.210 | 0.210 | - | - |

Note: Streams may be combined in which case capacity will be adjusted
 These values do not allow for any site-specific corrections

Junction Diagram

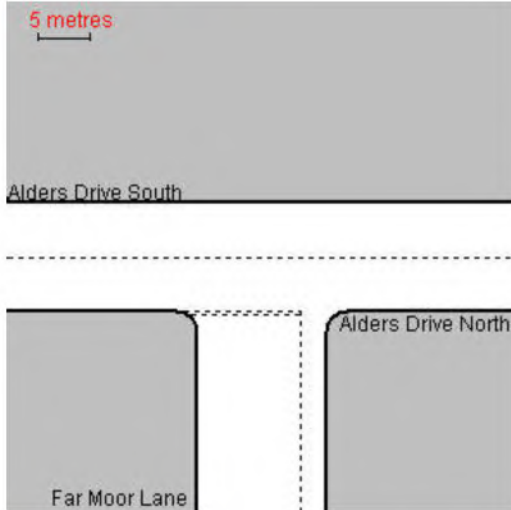

Demand Data

Modelling Periods

| Parameter | Period | Duration (min) | Segment Length (min) |
|------------------------|-------------|----------------|----------------------|
| First Modelling Period | 16:45-18:15 | 90 | 15 |

ODTAB Turning Counts

Demand Set: 2009 Far Moor Lane_ Alders Drive

Modelling Period: 16:45-18:15

| From/To | Arm A | Arm B | Arm C |
|---------|-------|-------|-------|
| Arm A | 0.0 | 19.0 | 372.0 |
| Arm B | 16.0 | 0.0 | 126.0 |
| Arm C | 422.0 | 222.0 | 0.0 |

ODTAB Synthesised Flows

Demand Set: 2009 Far Moor Lane_ Alders Drive

Modelling Period: 16:45-18:15

| Arm | Rising Time | Rising Flow (veh/min) | Peak Time | Peak Flow (veh/min) | Falling Time | Falling Flow (veh/min) |
|-------|-------------|-----------------------|-----------|---------------------|--------------|------------------------|
| Arm A | 17:00 | 4.887 | 17:00 | 7.331 | 17:30 | 4.887 |
| Arm B | 17:00 | 1.775 | 17:00 | 2.662 | 17:30 | 1.775 |
| Arm C | 17:00 | 8.050 | 17:00 | 12.075 | 17:30 | 8.050 |

Heavy Vehicles Percentages

Demand Set: 2009 Far Moor Lane_ Alders Drive

Modelling Period: 16:45-18:15

| From/To | Arm A | Arm B | Arm C |
|---------|-------|-------|-------|
| Arm A | - | 10.0 | 10.0 |
| Arm B | 10.0 | - | 10.0 |
| Arm C | 10.0 | 10.0 | - |

Default proportions of heavy vehicles are used

Queue Diagrams

Demand Set: Sum of Demand Sets for Modelling Period: 16:45 - 18:15

Modelling Period: 16:45-18:15

View Extent: 40m

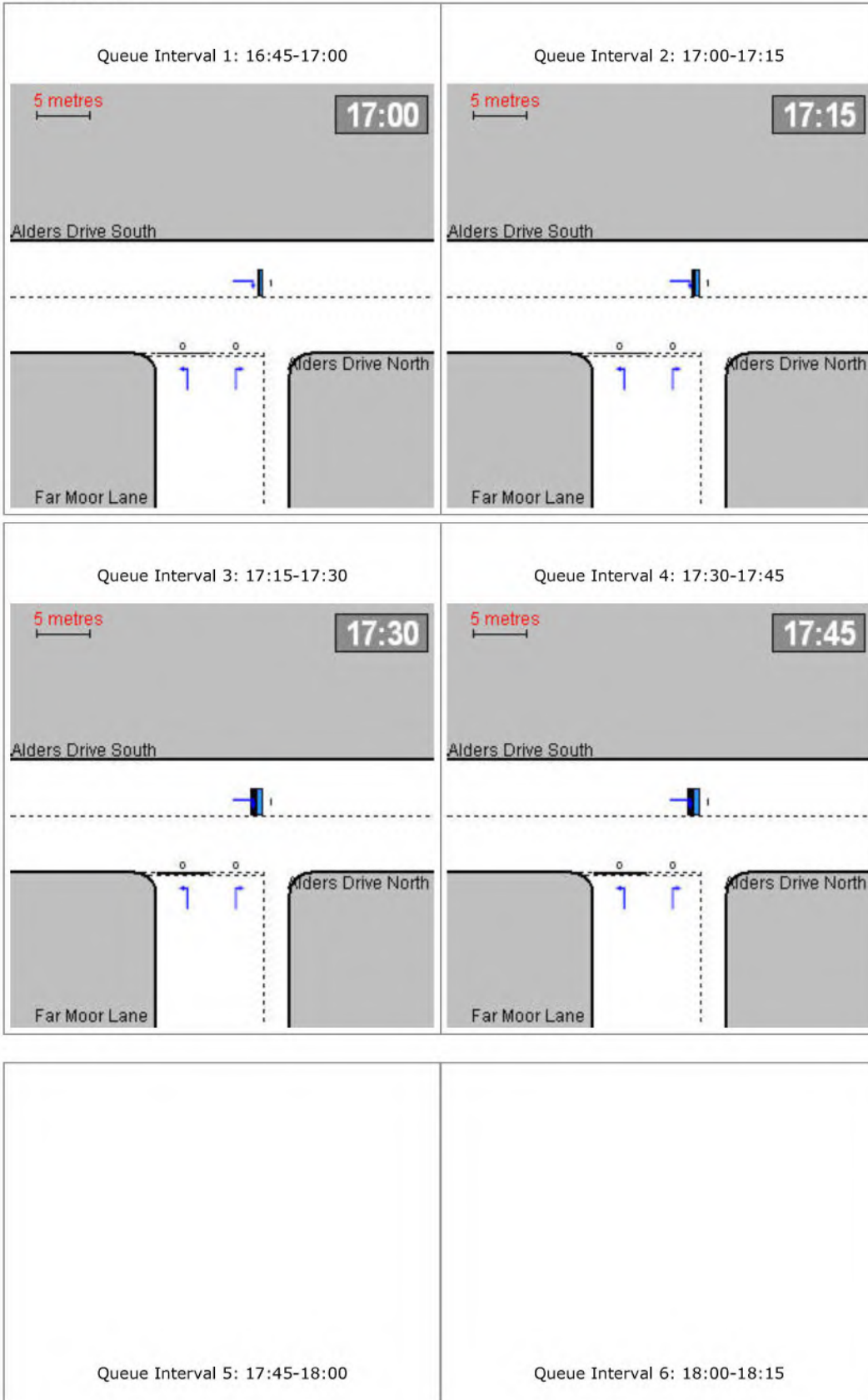

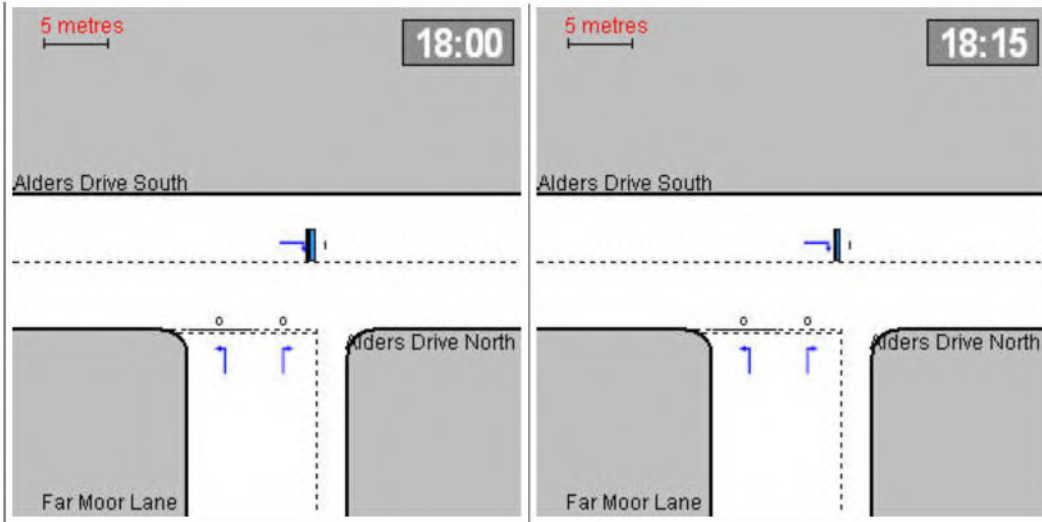

Capacity Graph

Demand Set: Sum of Demand Sets for Modelling Period: 16:45 - 18:15
Modelling Period: 16:45-18:15

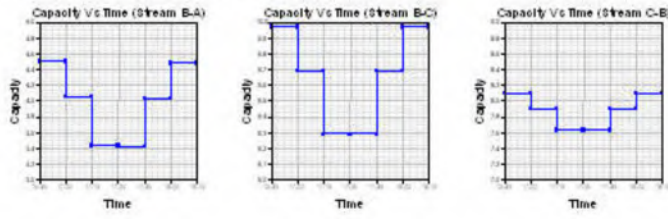

RFC Graph

Demand Set: Sum of Demand Sets for Modelling Period: 16:45 - 18:15
Modelling Period: 16:45-18:15

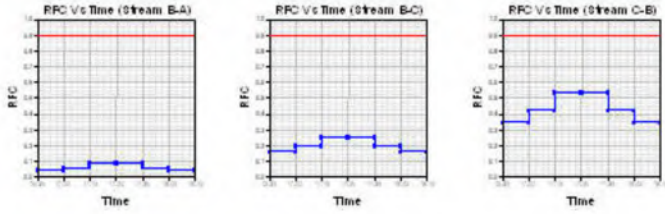

Start Queue Graph

Demand Set: Sum of Demand Sets for Modelling Period: 16:45 - 18:15
Modelling Period: 16:45-18:15

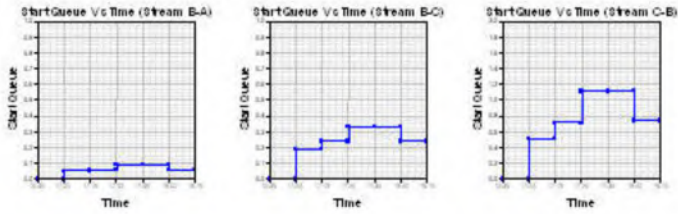

End Queue Graph

Demand Set: Sum of Demand Sets for Modelling Period: 16:45 - 18:15
Modelling Period: 16:45-18:15

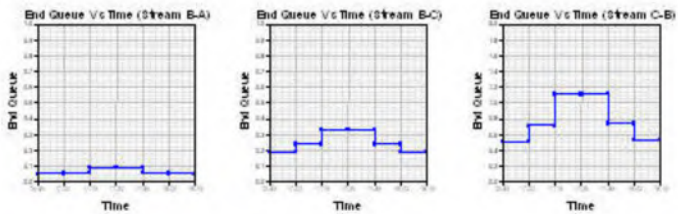

Delay Graph

Demand Set: Sum of Demand Sets for Modelling Period: 16:45 - 18:15
Modelling Period: 16:45-18:15

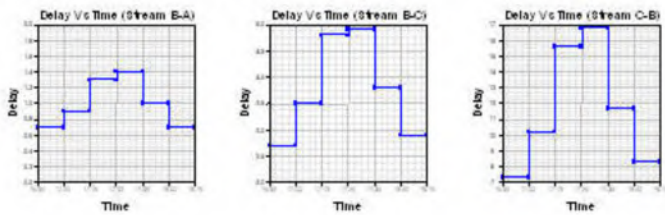

Queues & Delays

Demand Set: Sum of Demand Sets for Modelling Period: 16:45 - 18:15

Modelling Period: 16:45-18:15

| Segment | Stream | Demand (veh/min) | Capacity (veh/min) | RFC | Ped. Flow (ped/min) | Start Queue (veh) | End Queue (veh) | Geometric Delay (veh.min/segment) | Delay (veh.min/segment) | Mean Arriving Vehicle Delay (min) |
|-------------|--------|------------------|--------------------|-------|---------------------|-------------------|-----------------|-----------------------------------|-------------------------|-----------------------------------|
| 16:45-17:00 | B-A | 0.20 | 4.50 | 0.045 | - | 0.00 | 0.05 | - | 0.7 | 0.23 |
| | B-C | 1.58 | 9.97 | 0.159 | - | 0.00 | 0.19 | - | 2.7 | 0.12 |
| | C-A | 5.30 | - | - | - | - | - | - | - | - |
| | C-B | 2.79 | 8.10 | 0.344 | - | 0.00 | 0.51 | - | 7.3 | 0.19 |
| | A-B | 0.24 | - | - | - | - | - | - | - | - |
| | A-C | 4.67 | - | - | - | - | - | - | - | - |
| Segment | Stream | Demand (veh/min) | Capacity (veh/min) | RFC | Ped. Flow (ped/min) | Start Queue (veh) | End Queue (veh) | Geometric Delay (veh.min/segment) | Delay (veh.min/segment) | Mean Arriving Vehicle Delay (min) |
| 17:00-17:15 | B-A | 0.24 | 4.05 | 0.059 | - | 0.05 | 0.06 | - | 0.9 | 0.26 |
| | B-C | 1.89 | 9.69 | 0.195 | - | 0.19 | 0.24 | - | 3.5 | 0.13 |
| | C-A | 6.32 | - | - | - | - | - | - | - | - |
| | C-B | 3.33 | 7.90 | 0.421 | - | 0.51 | 0.71 | - | 10.2 | 0.22 |
| | A-B | 0.28 | - | - | - | - | - | - | - | - |
| | A-C | 5.57 | - | - | - | - | - | - | - | - |
| Segment | Stream | Demand (veh/min) | Capacity (veh/min) | RFC | Ped. Flow (ped/min) | Start Queue (veh) | End Queue (veh) | Geometric Delay (veh.min/segment) | Delay (veh.min/segment) | Mean Arriving Vehicle Delay (min) |
| 17:15-17:30 | B-A | 0.29 | 3.43 | 0.086 | - | 0.06 | 0.09 | - | 1.3 | 0.32 |
| | B-C | 2.31 | 9.29 | 0.249 | - | 0.24 | 0.33 | - | 4.8 | 0.14 |
| | C-A | 7.74 | - | - | - | - | - | - | - | - |
| | C-B | 4.07 | 7.63 | 0.534 | - | 0.71 | 1.11 | - | 15.6 | 0.28 |
| | A-B | 0.35 | - | - | - | - | - | - | - | - |
| | A-C | 6.83 | - | - | - | - | - | - | - | - |
| Segment | Stream | Demand (veh/min) | Capacity (veh/min) | RFC | Ped. Flow (ped/min) | Start Queue (veh) | End Queue (veh) | Geometric Delay (veh.min/segment) | Delay (veh.min/segment) | Mean Arriving Vehicle Delay (min) |
| 17:30-17:45 | B-A | 0.29 | 3.42 | 0.086 | - | 0.09 | 0.09 | - | 1.4 | 0.32 |
| | B-C | 2.31 | 9.29 | 0.249 | - | 0.33 | 0.33 | - | 4.9 | 0.14 |
| | C-A | 7.74 | - | - | - | - | - | - | - | - |
| | C-B | 4.07 | 7.63 | 0.534 | - | 1.11 | 1.12 | - | 16.8 | 0.28 |
| | A-B | 0.35 | - | - | - | - | - | - | - | - |
| | A-C | 6.83 | - | - | - | - | - | - | - | - |

| Segment | Stream | Demand (veh/min) | Capacity (veh/min) | RFC | Ped. Flow (ped/min) | Start Queue (veh) | End Queue (veh) | Geometric Delay (veh.min/segment) | Delay (veh.min/segment) | Mean Arriving Vehicle Delay (min) |
|-------------|--------|------------------|--------------------|-------|---------------------|-------------------|-----------------|-----------------------------------|-------------------------|-----------------------------------|
| 17:45-18:00 | B-A | 0.24 | 4.03 | 0.059 | - | 0.09 | 0.06 | - | 1.0 | 0.26 |
| | B-C | 1.89 | 9.69 | 0.195 | - | 0.33 | 0.24 | - | 3.8 | 0.13 |
| | C-A | 6.32 | - | - | - | - | - | - | - | - |
| | C-B | 3.33 | 7.90 | 0.421 | - | 1.12 | 0.74 | - | 11.7 | 0.22 |
| | A-B | 0.28 | - | - | - | - | - | - | - | - |
| | A-C | 5.57 | - | - | - | - | - | - | - | - |
| Segment | Stream | Demand (veh/min) | Capacity (veh/min) | RFC | Ped. Flow (ped/min) | Start Queue (veh) | End Queue (veh) | Geometric Delay (veh.min/segment) | Delay (veh.min/segment) | Mean Arriving Vehicle Delay (min) |
| 18:00-18:15 | B-A | 0.20 | 4.48 | 0.045 | - | 0.06 | 0.05 | - | 0.7 | 0.23 |
| | B-C | 1.58 | 9.97 | 0.159 | - | 0.24 | 0.19 | - | 2.9 | 0.12 |
| | C-A | 5.30 | - | - | - | - | - | - | - | - |
| | C-B | 2.79 | 8.10 | 0.344 | - | 0.74 | 0.53 | - | 8.3 | 0.19 |
| | A-B | 0.24 | - | - | - | - | - | - | - | - |
| | A-C | 4.67 | - | - | - | - | - | - | - | - |

Entry capacities marked with an '(X)' are dominated by a pedestrian crossing in that time segment.
 In time segments marked with a '(B)', traffic leaving the junction may block back from a crossing so impairing normal operation of the junction.
 Delays marked with '# #' could not be calculated.

Overall Queues & Delays

Queueing Delay Information Over Whole Period

Demand Set: Sum of Demand Sets for Modelling Period: 16:45 - 18:15
Modelling Period: 16:45-18:15

| Stream | Total Demand (veh) | Total Demand (veh/h) | Queueing Delay (min) | Queueing Delay (min/veh) | Inclusive Delay (min) | Inclusive Delay (min/veh) |
|------------|--------------------|----------------------|----------------------|--------------------------|-----------------------|---------------------------|
| B-A | 22.0 | 14.7 | 6.0 | 0.3 | 6.0 | 0.3 |
| B-C | 173.4 | 115.6 | 22.6 | 0.1 | 22.6 | 0.1 |
| C-A | 580.9 | 387.2 | - | - | - | - |
| C-B | 305.6 | 203.7 | 69.9 | 0.2 | 69.9 | 0.2 |
| A-B | 26.2 | 17.4 | - | - | - | - |
| A-C | 512.0 | 341.4 | - | - | - | - |
| All | 1620.1 | 1080.0 | 98.5 | 0.1 | 98.5 | 0.1 |

Delay is that occurring only within the time period.
 Inclusive delay includes delay suffered by vehicles which are still queuing after the end of the time period.
 These will only be significantly different if there is a large queue remaining at the end of the time period.

PICADY 5 Run Successful

| PICADY | | |
|---|---|---|
| GUI Version: 5.00 AC Analysis Program Release: 3.0 INTERIM (MAR 2006) | | |
| © Copyright TRL Limited, 2006 Adapted from PICADY/3 which is Crown Copyright by permission of the controller of HMSO | | |
| For sales and distribution information, program advice and maintenance, contact: | | |
| TRL Limited Crowthorne House Nine Mile Ride Wokingham, Berks. RG40 3GA, UK |  | Tel: +44 (0)1344 770758 Fax: +44 (0)1344 770864 E-mail: softwarebureau@trl.co.uk Web: www.trlsoftware.co.uk |
| The user of this computer program for the solution of an engineering problem is in no way relieved of their responsibility for the correctness of the solution | | |

Run Analysis

| Parameter | Values |
|--------------|--|
| File Run | G:\..\Far Moor Lane Alders Drive T junction\2017 AM Peak.vpi |
| Date Run | 23 September 2009 |
| Time Run | 15:45:22 |
| Driving Side | Drive On The Left |

Arm Names and Flow Scaling Factors

| Arm | Arm Name | Flow Scaling Factor (%) |
|-------|--------------------|-------------------------|
| Arm A | Alders Drive North | 100 |
| Arm B | Far Moor Lane | 100 |
| Arm C | Alders Drive South | 100 |

Stream Labelling Convention

Stream A-B contains traffic going from A to B etc.

Run Information

| Parameter | Values |
|-------------|--|
| Run Title | 2017 Far Moor Lane_ Alders Drive AM Peak |
| Location | Redditch |
| Date | 23 September 2009 |
| Enumerator | lbates [HP24852250691] |
| Job Number | 835 |
| Status | Preliminary |
| Client | Redditch Borough Council |
| Description | - |

Errors and Warnings

| Parameter | Values |
|-----------|-----------------------|
| Warning | No Errors Or Warnings |

Geometric Data

Geometric Parameters

| Parameter | Minor Arm B |
|---|-------------|
| Major Road Carriageway Width (m) | 8.30 |
| Major Road Kerbed Central Reserve Width (m) | 0.00 |
| Major Road Right Turning Lane Width (m) | 2.20 |
| Minor Road Width 0m Back from Junction (m) | 10.00 |
| Minor Road Width 5m Back from Junction (m) | 6.50 |
| Minor Road Width 10m Back from Junction (m) | 5.25 |
| Minor Road Width 15m Back from Junction (m) | 4.50 |
| Minor Road Width 20m Back from Junction (m) | 4.00 |
| Minor Road Flare Length (veh) | 1 |
| Minor Road Visibility To Right (m) | 27 |
| Minor Road Visibility To Left (m) | 27 |
| Major Road Right Turn Visibility (m) | 50 |
| Major Road Right Turn Blocks Traffic | No |

Slope and Intercept Values

| Stream | Intercept for Stream B-A | Slope for A-B | Slope for A-C | Slope for C-A | Slope for C-B |
|--------|--------------------------|---------------|---------------|---------------|---------------|
| B-A | 459.592 | 0.075 | 0.190 | 0.120 | 0.272 |
| B-C | 589.599 | 0.081 | 0.206 | - | - |
| C-B | 602.919 | 0.210 | 0.210 | - | - |

Note: Streams may be combined in which case capacity will be adjusted
These values do not allow for any site-specific corrections

Junction Diagram

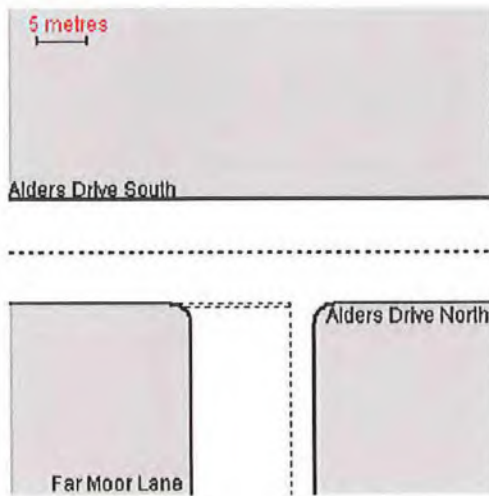

Demand Data

Modelling Periods

| Parameter | Period | Duration (min) | Segment Length (min) |
|------------------------|-------------|----------------|----------------------|
| First Modelling Period | 07:45-09:15 | 90 | 15 |

ODTAB Turning Counts

Demand Set: 2009 Far Moor Lane_ Alders Drive
Modelling Period: 07:45-09:15

| From/To | Arm A | Arm B | Arm C |
|---------|-------|-------|-------|
| Arm A | 0.0 | 10.0 | 197.0 |
| Arm B | 33.0 | 0.0 | 263.0 |
| Arm C | 209.0 | 110.0 | 0.0 |

ODTAB Synthesised Flows

Demand Set: 2009 Far Moor Lane_ Alders Drive
Modelling Period: 07:45-09:15

| Arm | Rising Time | Rising Flow (veh/min) | Peak Time | Peak Flow (veh/min) | Falling Time | Falling Flow (veh/min) |
|-------|-------------|-----------------------|-----------|---------------------|--------------|------------------------|
| Arm A | 08:00 | 2.588 | 08:00 | 3.881 | 08:30 | 2.588 |
| Arm B | 08:00 | 3.700 | 08:00 | 5.550 | 08:30 | 3.700 |
| Arm C | 08:00 | 3.987 | 08:00 | 5.981 | 08:30 | 3.987 |

Heavy Vehicles Percentages

Demand Set: 2009 Far Moor Lane_ Alders Drive
Modelling Period: 07:45-09:15

| From/To | Arm A | Arm B | Arm C |
|---------|-------|-------|-------|
| Arm A | - | 10.0 | 10.0 |
| Arm B | 10.0 | - | 10.0 |
| Arm C | 10.0 | 10.0 | - |

Default proportions of heavy vehicles are used

Queue Diagrams

Demand Set: Sum of Demand Sets for Modelling Period: 07:45 - 09:15

Modelling Period: 07:45-09:15

View Extent: 40m

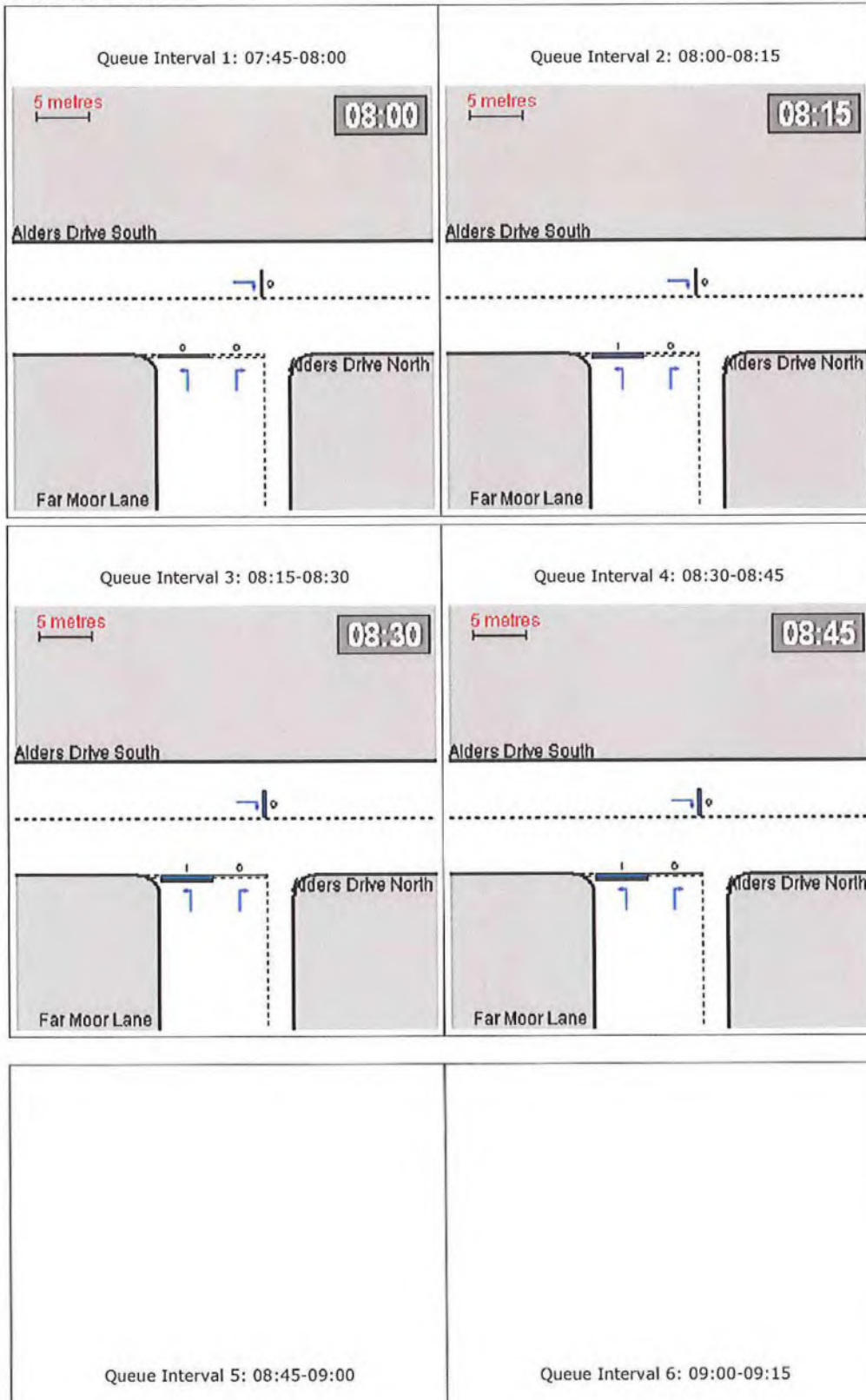

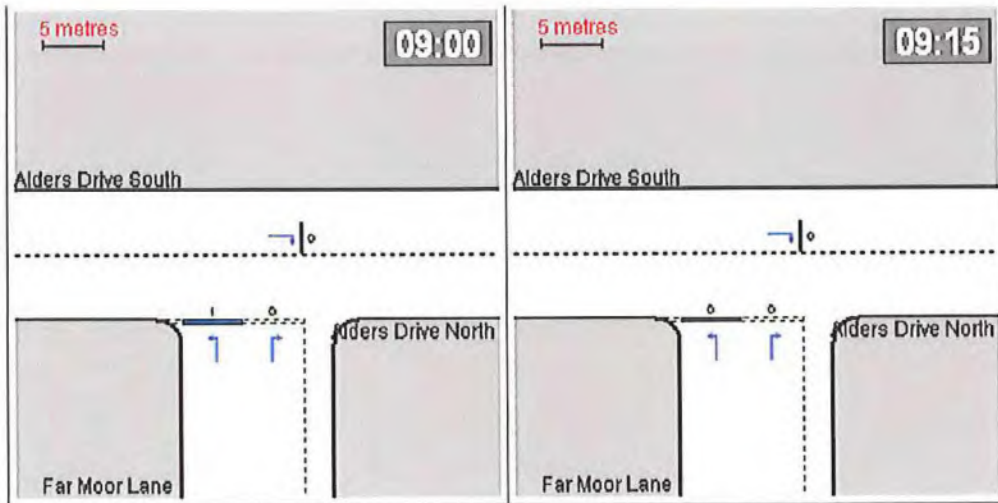

Capacity Graph

Demand Set: Sum of Demand Sets for Modelling Period: 07:45 - 09:15
Modelling Period: 07:45-09:15

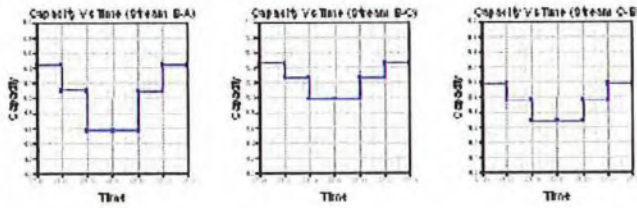

RFC Graph

Demand Set: Sum of Demand Sets for Modelling Period: 07:45 - 09:15
 Modelling Period: 07:45-09:15

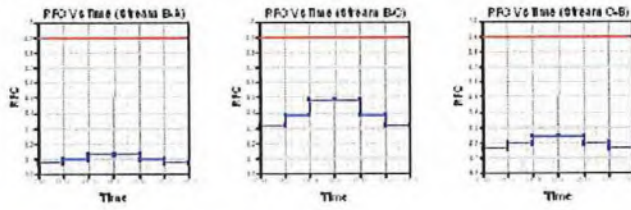

Start Queue Graph

Demand Set: Sum of Demand Sets for Modelling Period: 07:45 - 09:15
 Modelling Period: 07:45-09:15

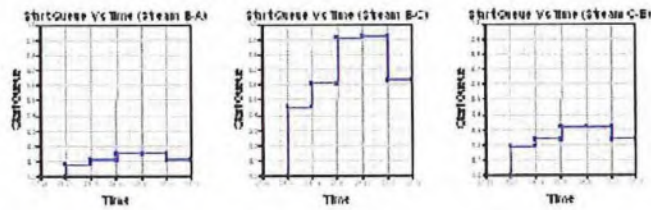

End Queue Graph

Demand Set: Sum of Demand Sets for Modelling Period: 07:45 - 09:15
 Modelling Period: 07:45-09:15

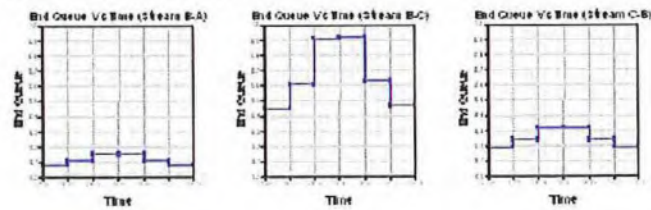

Delay Graph

Demand Set: Sum of Demand Sets for Modelling Period: 07:45 - 09:15
 Modelling Period: 07:45-09:15

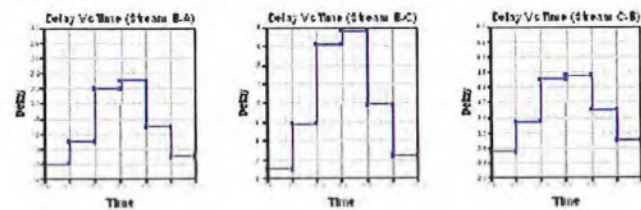

Queues & Delays

Demand Set: Sum of Demand Sets for Modelling Period: 07:45 - 09:15
Modelling Period: 07:45-09:15

| Segment | Stream | Demand (veh/min) | Capacity (veh/min) | RFC | Ped. Flow (ped/min) | Start Queue (veh) | End Queue (veh) | Geometric Delay (veh.min/segment) | Delay (veh.min/segment) | Mean Arriving Vehicle Delay (min) |
|-------------|--------|------------------|--------------------|-------|---------------------|-------------------|-----------------|-----------------------------------|-------------------------|-----------------------------------|
| 07:45-08:00 | B-A | 0.41 | 5.45 | 0.076 | - | 0.00 | 0.08 | - | 1.2 | 0.20 |
| | B-C | 3.30 | 10.46 | 0.315 | - | 0.00 | 0.45 | - | 6.5 | 0.14 |
| | C-A | 2.62 | - | - | - | - | - | - | - | - |
| | C-B | 1.38 | 8.59 | 0.161 | - | 0.00 | 0.19 | - | 2.7 | 0.14 |
| | A-B | 0.13 | - | - | - | - | - | - | - | - |
| | A-C | 2.47 | - | - | - | - | - | - | - | - |
| 08:00-08:15 | B-A | 0.49 | 5.11 | 0.097 | - | 0.08 | 0.11 | - | 1.5 | 0.22 |
| | B-C | 3.94 | 10.27 | 0.384 | - | 0.45 | 0.61 | - | 8.9 | 0.16 |
| | C-A | 3.13 | - | - | - | - | - | - | - | - |
| | C-B | 1.65 | 8.48 | 0.194 | - | 0.19 | 0.24 | - | 3.5 | 0.15 |
| | A-B | 0.15 | - | - | - | - | - | - | - | - |
| | A-C | 2.95 | - | - | - | - | - | - | - | - |
| 08:15-08:30 | B-A | 0.61 | 4.57 | 0.132 | - | 0.11 | 0.15 | - | 2.2 | 0.25 |
| | B-C | 4.83 | 9.99 | 0.483 | - | 0.61 | 0.91 | - | 13.1 | 0.19 |
| | C-A | 3.84 | - | - | - | - | - | - | - | - |
| | C-B | 2.02 | 8.34 | 0.242 | - | 0.24 | 0.32 | - | 4.6 | 0.16 |
| | A-B | 0.18 | - | - | - | - | - | - | - | - |
| | A-C | 3.62 | - | - | - | - | - | - | - | - |
| 08:30-08:45 | B-A | 0.61 | 4.57 | 0.133 | - | 0.15 | 0.15 | - | 2.3 | 0.25 |
| | B-C | 4.83 | 9.99 | 0.483 | - | 0.91 | 0.92 | - | 13.8 | 0.19 |
| | C-A | 3.84 | - | - | - | - | - | - | - | - |
| | C-B | 2.02 | 8.34 | 0.242 | - | 0.32 | 0.32 | - | 4.7 | 0.16 |
| | A-B | 0.18 | - | - | - | - | - | - | - | - |
| | A-C | 3.62 | - | - | - | - | - | - | - | - |

| Segment | Stream | Demand (veh/min) | Capacity (veh/min) | RFC | Ped. Flow (ped/min) | Start Queue (veh) | End Queue (veh) | Geometric Delay (veh.min/segment) | Delay (veh.min/segment) | Mean Arriving Vehicle Delay (min) |
|-------------|--------|------------------|--------------------|-------|---------------------|-------------------|-----------------|-----------------------------------|-------------------------|-----------------------------------|
| 08:45-09:00 | B-A | 0.49 | 5.10 | 0.097 | - | 0.15 | 0.11 | - | 1.7 | 0.22 |
| | B-C | 3.94 | 10.27 | 0.384 | - | 0.92 | 0.63 | - | 9.9 | 0.16 |
| | C-A | 3.13 | - | - | - | - | - | - | - | - |
| | C-B | 1.65 | 8.48 | 0.194 | - | 0.32 | 0.24 | - | 3.8 | 0.15 |
| | A-B | 0.15 | - | - | - | - | - | - | - | - |
| | A-C | 2.95 | - | - | - | - | - | - | - | - |

| Segment | Stream | Demand (veh/min) | Capacity (veh/min) | RFC | Ped. Flow (ped/min) | Start Queue (veh) | End Queue (veh) | Geometric Delay (veh.min/segment) | Delay (veh.min/segment) | Mean Arriving Vehicle Delay (min) |
|-------------|--------|------------------|--------------------|-------|---------------------|-------------------|-----------------|-----------------------------------|-------------------------|-----------------------------------|
| 09:00-09:15 | B-A | 0.41 | 5.44 | 0.076 | - | 0.11 | 0.08 | - | 1.3 | 0.20 |
| | B-C | 3.30 | 10.46 | 0.316 | - | 0.63 | 0.47 | - | 7.2 | 0.14 |
| | C-A | 2.62 | - | - | - | - | - | - | - | - |
| | C-B | 1.38 | 8.59 | 0.161 | - | 0.24 | 0.19 | - | 3.0 | 0.14 |
| | A-B | 0.13 | - | - | - | - | - | - | - | - |
| | A-C | 2.47 | - | - | - | - | - | - | - | - |

Entry capacities marked with an '(X)' are dominated by a pedestrian crossing in that time segment.
 In time segments marked with a '(B)', traffic leaving the junction may block back from a crossing so impairing normal operation of the junction.
 Delays marked with '###' could not be calculated.

Overall Queues & Delays

Queueing Delay Information Over Whole Period

Demand Set: Sum of Demand Sets for Modelling Period: 07:45 - 09:15
Modelling Period: 07:45-09:15

| Stream | Total Demand (veh) | Total Demand (veh/h) | Queueing Delay (min) | Queueing Delay (min/veh) | Inclusive Delay (min) | Inclusive Delay (min/veh) |
|------------|--------------------|----------------------|----------------------|--------------------------|-----------------------|---------------------------|
| B-A | 45.4 | 30.3 | 10.1 | 0.2 | 10.1 | 0.2 |
| B-C | 362.0 | 241.3 | 59.4 | 0.2 | 59.4 | 0.2 |
| C-A | 287.7 | 191.8 | - | - | - | - |
| C-B | 151.4 | 100.9 | 22.3 | 0.1 | 22.3 | 0.1 |
| A-B | 13.8 | 9.2 | - | - | - | - |
| A-C | 271.2 | 180.8 | - | - | - | - |
| All | 1131.4 | 754.3 | 91.8 | 0.1 | 91.8 | 0.1 |

Delay is that occurring only within the time period.
 Inclusive delay includes delay suffered by vehicles which are still queuing after the end of the time period.
 These will only be significantly different if there is a large queue remaining at the end of the time period.

PICADY 5 Run Successful

| PICADY | | |
|---|---|---|
| GUI Version: 5.00 AC Analysis Program Release: 3.0 INTERIM (MAR 2006) | | |
| © Copyright TRL Limited, 2006 Adapted from PICADY/3 which is Crown Copyright by permission of the controller of HMSO | | |
| For sales and distribution information, program advice and maintenance, contact: | | |
| TRL Limited Crowthorne House Nine Mile Ride Wokingham, Berks. RG40 3GA, UK |  | Tel: +44 (0)1344 770758 Fax: +44 (0)1344 770864 E-mail: softwarebureau@trl.co.uk Web: www.trlsoftware.co.uk |
| The user of this computer program for the solution of an engineering problem is in no way relieved of their responsibility for the correctness of the solution | | |

Run Analysis

| Parameter | Values |
|--------------|--|
| File Run | G:\..\Far Moor Lane Alders Drive T junction\2017 PM Peak.vpi |
| Date Run | 23 September 2009 |
| Time Run | 15:46:45 |
| Driving Side | Drive On The Left |

Arm Names and Flow Scaling Factors

| Arm | Arm Name | Flow Scaling Factor (%) |
|-------|--------------------|-------------------------|
| Arm A | Alders Drive North | 100 |
| Arm B | Far Moor Lane | 100 |
| Arm C | Alders Drive South | 100 |

Stream Labelling Convention

Stream A-B contains traffic going from A to B etc.

Run Information

| Parameter | Values |
|-------------|--|
| Run Title | 2017 Far Moor Lane_ Alders Drive PM Peak |
| Location | Redditch |
| Date | 23 September 2009 |
| Enumerator | lbates [HP24852250691] |
| Job Number | 835 |
| Status | Preliminary |
| Client | Redditch Borough Council |
| Description | - |

Errors and Warnings

| Parameter | Values |
|-----------|-----------------------|
| Warning | No Errors Or Warnings |

Geometric Data

Geometric Parameters

| Parameter | Minor Arm B |
|---|-------------|
| Major Road Carriageway Width (m) | 8.30 |
| Major Road Kerbed Central Reserve Width (m) | 0.00 |
| Major Road Right Turning Lane Width (m) | 2.20 |
| Minor Road Width 0m Back from Junction (m) | 10.00 |
| Minor Road Width 5m Back from Junction (m) | 6.50 |
| Minor Road Width 10m Back from Junction (m) | 5.25 |
| Minor Road Width 15m Back from Junction (m) | 4.50 |
| Minor Road Width 20m Back from Junction (m) | 4.00 |
| Minor Road Flare Length (veh) | 1 |
| Minor Road Visibility To Right (m) | 27 |
| Minor Road Visibility To Left (m) | 27 |
| Major Road Right Turn Visibility (m) | 50 |
| Major Road Right Turn Blocks Traffic | No |

Slope and Intercept Values

| Stream | Intercept for Stream B-A | Slope for A-B | Slope for A-C | Slope for C-A | Slope for C-B |
|--------|--------------------------|---------------|---------------|---------------|---------------|
| B-A | 459.592 | 0.075 | 0.190 | 0.120 | 0.272 |
| B-C | 589.599 | 0.081 | 0.206 | - | - |
| C-B | 602.919 | 0.210 | 0.210 | - | - |

Note: Streams may be combined in which case capacity will be adjusted
These values do not allow for any site-specific corrections

Junction Diagram

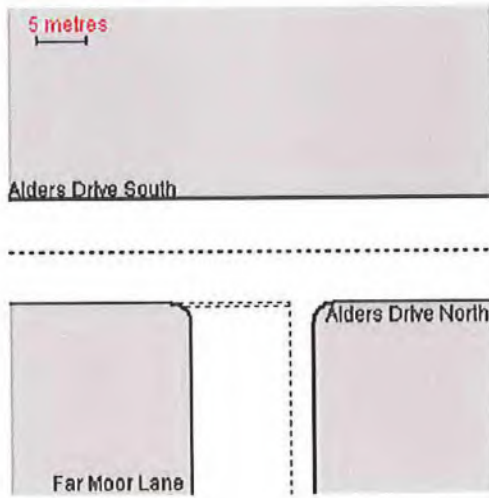

Demand Data

Modelling Periods

| Parameter | Period | Duration (min) | Segment Length (min) |
|------------------------|-------------|----------------|----------------------|
| First Modelling Period | 16:45-18:15 | 90 | 15 |

ODTAB Turning Counts

Demand Set: 2009 Far Moor Lane_ Alders Drive
 Modelling Period: 16:45-18:15

| From/To | Arm A | Arm B | Arm C |
|---------|-------|-------|-------|
| Arm A | 0.0 | 22.0 | 421.0 |
| Arm B | 18.0 | 0.0 | 143.0 |
| Arm C | 478.0 | 251.0 | 0.0 |

ODTAB Synthesised Flows

Demand Set: 2009 Far Moor Lane_ Alders Drive
Modelling Period: 16:45-18:15

| Arm | Rising Time | Rising Flow (veh/min) | Peak Time | Peak Flow (veh/min) | Falling Time | Falling Flow (veh/min) |
|-------|-------------|-----------------------|-----------|---------------------|--------------|------------------------|
| Arm A | 17:00 | 5.537 | 17:00 | 8.306 | 17:30 | 5.537 |
| Arm B | 17:00 | 2.013 | 17:00 | 3.019 | 17:30 | 2.013 |
| Arm C | 17:00 | 9.113 | 17:00 | 13.669 | 17:30 | 9.113 |

Heavy Vehicles Percentages

Demand Set: 2009 Far Moor Lane_ Alders Drive
Modelling Period: 16:45-18:15

| From/To | Arm A | Arm B | Arm C |
|---------|-------|-------|-------|
| Arm A | - | 10.0 | 10.0 |
| Arm B | 10.0 | - | 10.0 |
| Arm C | 10.0 | 10.0 | - |

Default proportions of heavy vehicles are used

Queue Diagrams

Demand Set: Sum of Demand Sets for Modelling Period: 16:45 - 18:15
Modelling Period: 16:45-18:15
View Extent: 40m

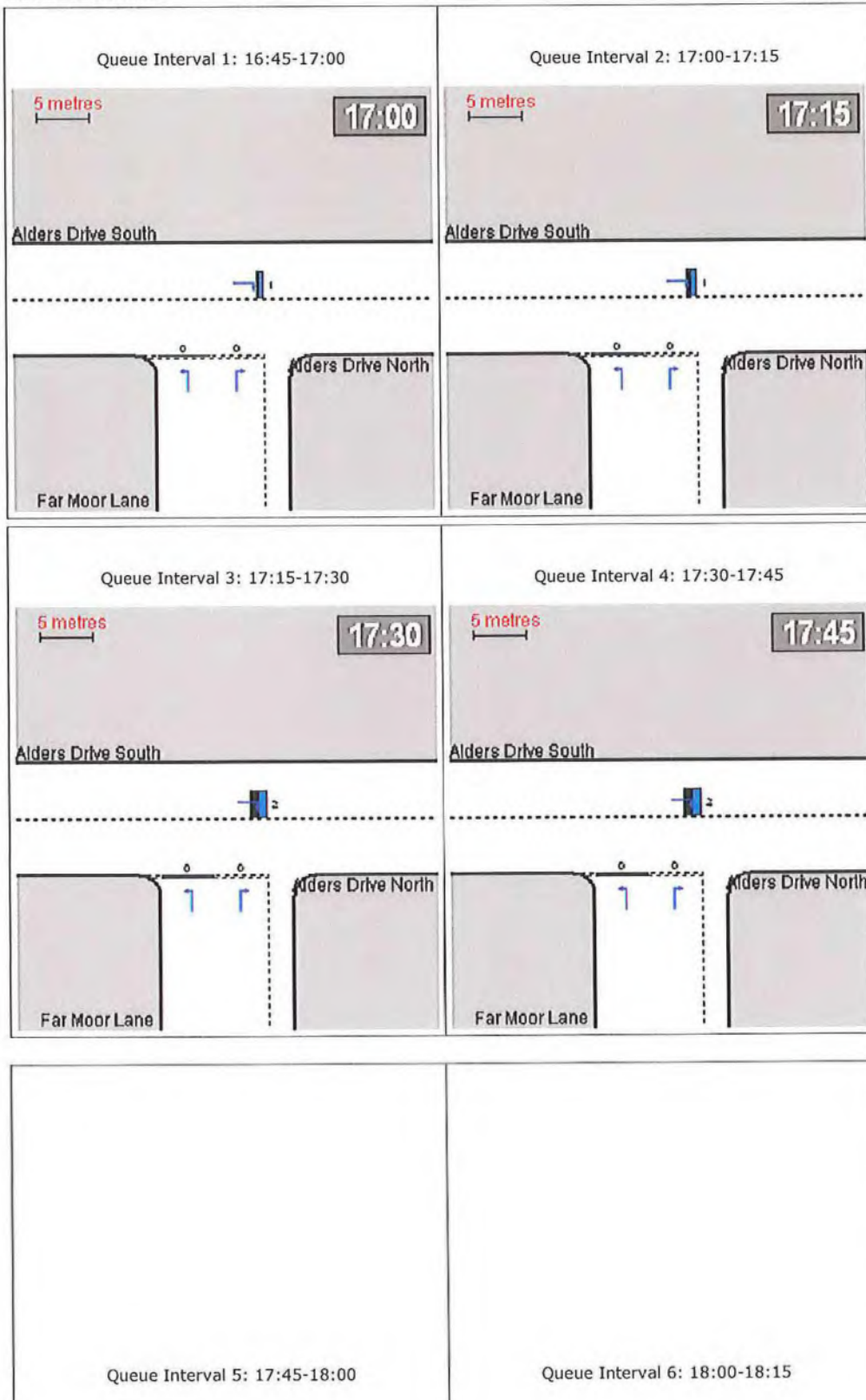

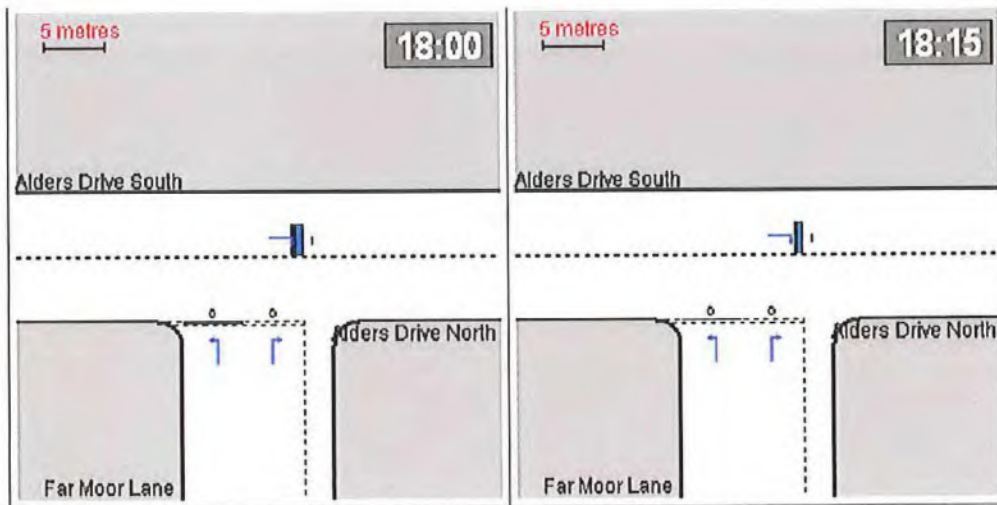

Capacity Graph

Demand Set: Sum of Demand Sets for Modelling Period: 16:45 - 18:15
Modelling Period: 16:45-18:15

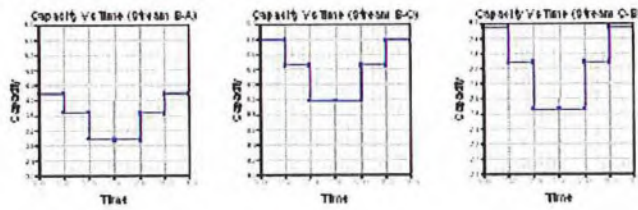

RFC Graph

Demand Set: Sum of Demand Sets for Modelling Period: 16:45 - 18:15
 Modelling Period: 16:45-18:15

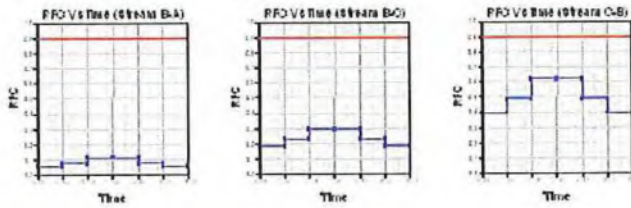

Start Queue Graph

Demand Set: Sum of Demand Sets for Modelling Period: 16:45 - 18:15
 Modelling Period: 16:45-18:15

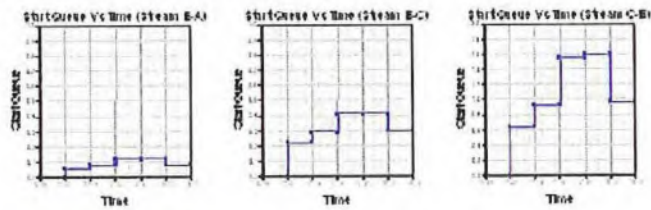

End Queue Graph

Demand Set: Sum of Demand Sets for Modelling Period: 16:45 - 18:15
 Modelling Period: 16:45-18:15

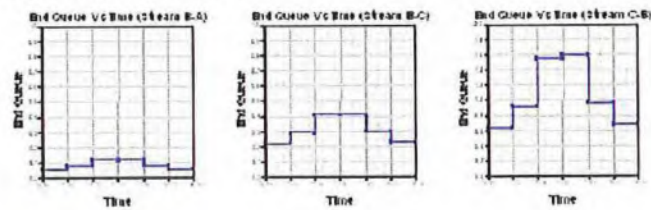

Delay Graph

Demand Set: Sum of Demand Sets for Modelling Period: 16:45 - 18:15
 Modelling Period: 16:45-18:15

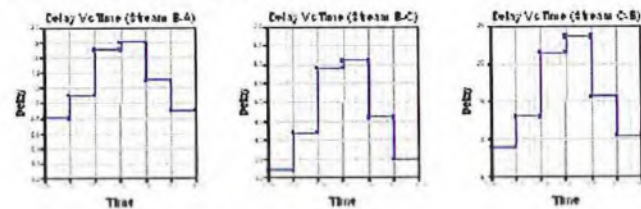

Queues & Delays

Demand Set: Sum of Demand Sets for Modelling Period: 16:45 - 18:15

Modelling Period: 16:45-18:15

| Segment | Stream | Demand (veh/min) | Capacity (veh/min) | RFC | Ped. Flow (ped/min) | Start Queue (veh) | End Queue (veh) | Geometric Delay (veh.min/segment) | Delay (veh.min/segment) | Mean Arriving Vehicle Delay (min) |
|-------------|--------|------------------|--------------------|-------|---------------------|-------------------|-----------------|-----------------------------------|-------------------------|-----------------------------------|
| 16:45-17:00 | B-A | 0.23 | 4.20 | 0.054 | - | 0.00 | 0.06 | - | 0.8 | 0.25 |
| | B-C | 1.79 | 9.79 | 0.183 | - | 0.00 | 0.22 | - | 3.2 | 0.12 |
| | C-A | 6.00 | - | - | - | - | - | - | - | - |
| | C-B | 3.15 | 7.97 | 0.395 | - | 0.00 | 0.64 | - | 9.0 | 0.20 |
| | A-B | 0.28 | - | - | - | - | - | - | - | - |
| | A-C | 5.28 | - | - | - | - | - | - | - | - |
| 17:00-17:15 | B-A | 0.27 | 3.68 | 0.073 | - | 0.06 | 0.08 | - | 1.1 | 0.29 |
| | B-C | 2.14 | 9.46 | 0.226 | - | 0.22 | 0.29 | - | 4.2 | 0.14 |
| | C-A | 7.16 | - | - | - | - | - | - | - | - |
| | C-B | 3.76 | 7.74 | 0.486 | - | 0.64 | 0.92 | - | 13.1 | 0.25 |
| | A-B | 0.33 | - | - | - | - | - | - | - | - |
| | A-C | 6.31 | - | - | - | - | - | - | - | - |
| 17:15-17:30 | B-A | 0.33 | 2.97 | 0.111 | - | 0.08 | 0.12 | - | 1.7 | 0.38 |
| | B-C | 2.62 | 8.99 | 0.292 | - | 0.29 | 0.41 | - | 5.9 | 0.16 |
| | C-A | 8.77 | - | - | - | - | - | - | - | - |
| | C-B | 4.61 | 7.43 | 0.620 | - | 0.92 | 1.55 | - | 21.4 | 0.34 |
| | A-B | 0.40 | - | - | - | - | - | - | - | - |
| | A-C | 7.73 | - | - | - | - | - | - | - | - |
| 17:30-17:45 | B-A | 0.33 | 2.96 | 0.111 | - | 0.12 | 0.12 | - | 1.8 | 0.38 |
| | B-C | 2.62 | 8.99 | 0.292 | - | 0.41 | 0.41 | - | 6.1 | 0.16 |
| | C-A | 8.77 | - | - | - | - | - | - | - | - |
| | C-B | 4.61 | 7.43 | 0.620 | - | 1.55 | 1.59 | - | 23.5 | 0.35 |
| | A-B | 0.40 | - | - | - | - | - | - | - | - |
| | A-C | 7.73 | - | - | - | - | - | - | - | - |

| Segment | Stream | Demand (veh/min) | Capacity (veh/min) | RFC | Ped. Flow (ped/min) | Start Queue (veh) | End Queue (veh) | Geometric Delay (veh.min/segment) | Delay (veh.min/segment) | Mean Arriving Vehicle Delay (min) |
|-------------|--------|------------------|--------------------|-------|---------------------|-------------------|-----------------|-----------------------------------|-------------------------|-----------------------------------|
| 17:45-18:00 | B-A | 0.27 | 3.66 | 0.074 | - | 0.12 | 0.08 | - | 1.3 | 0.30 |
| | B-C | 2.14 | 9.46 | 0.227 | - | 0.41 | 0.30 | - | 4.6 | 0.14 |
| | C-A | 7.16 | - | - | - | - | - | - | - | - |
| | C-B | 3.76 | 7.74 | 0.486 | - | 1.59 | 0.97 | - | 15.6 | 0.26 |
| | A-B | 0.33 | - | - | - | - | - | - | - | - |
| | A-C | 6.31 | - | - | - | - | - | - | - | - |

| Segment | Stream | Demand (veh/min) | Capacity (veh/min) | RFC | Ped. Flow (ped/min) | Start Queue (veh) | End Queue (veh) | Geometric Delay (veh.min/segment) | Delay (veh.min/segment) | Mean Arriving Vehicle Delay (min) |
|-------------|--------|------------------|--------------------|-------|---------------------|-------------------|-----------------|-----------------------------------|-------------------------|-----------------------------------|
| 18:00-18:15 | B-A | 0.23 | 4.18 | 0.054 | - | 0.08 | 0.06 | - | 0.9 | 0.25 |
| | B-C | 1.79 | 9.78 | 0.183 | - | 0.30 | 0.23 | - | 3.5 | 0.13 |
| | C-A | 6.00 | - | - | - | - | - | - | - | - |
| | C-B | 3.15 | 7.97 | 0.395 | - | 0.97 | 0.67 | - | 10.5 | 0.21 |
| | A-B | 0.28 | - | - | - | - | - | - | - | - |
| | A-C | 5.28 | - | - | - | - | - | - | - | - |

Entry capacities marked with an '(X)' are dominated by a pedestrian crossing in that time segment.
 In time segments marked with a '(B)', traffic leaving the junction may block back from a crossing so impairing normal operation of the junction.
 Delays marked with '##' could not be calculated.

Overall Queues & Delays

Queueing Delay Information Over Whole Period

Demand Set: Sum of Demand Sets for Modelling Period: 16:45 - 18:15
Modelling Period: 16:45-18:15

| Stream | Total Demand (veh) | Total Demand (veh/h) | Queueing Delay (min) | Queueing Delay (min/veh) | Inclusive Delay (min) | Inclusive Delay (min/veh) |
|------------|--------------------|----------------------|----------------------|--------------------------|-----------------------|---------------------------|
| B-A | 24.8 | 16.5 | 7.7 | 0.3 | 7.7 | 0.3 |
| B-C | 196.8 | 131.2 | 27.5 | 0.1 | 27.5 | 0.1 |
| C-A | 657.9 | 438.6 | - | - | - | - |
| C-B | 345.5 | 230.3 | 93.1 | 0.3 | 93.1 | 0.3 |
| A-B | 30.3 | 20.2 | - | - | - | - |
| A-C | 579.5 | 386.3 | - | - | - | - |
| All | 1834.8 | 1223.2 | 128.3 | 0.1 | 128.3 | 0.1 |

Delay is that occurring only within the time period.
 Inclusive delay includes delay suffered by vehicles which are still queuing after the end of the time period.
 These will only be significantly different if there is a large queue remaining at the end of the time period.

PICADY 5 Run Successful

| PICADY | | |
|---|---|---|
| GUI Version: 5.00 AC Analysis Program Release: 3.0 INTERIM (MAR 2006) | | |
| © Copyright TRL Limited, 2006 Adapted from PICADY/3 which is Crown Copyright by permission of the controller of HMSO | | |
| For sales and distribution information, program advice and maintenance, contact: | | |
| TRL Limited Crowthorne House Nine Mile Ride Wokingham, Berks. RG40 3GA, UK |  | Tel: +44 (0)1344 770758 Fax: +44 (0)1344 770864 E-mail: softwarebureau@trl.co.uk Web: www.trlsoftware.co.uk |
| The user of this computer program for the solution of an engineering problem is in no way relieved of their responsibility for the correctness of the solution | | |

Run Analysis

| Parameter | Values |
|--------------|--|
| File Run | G:\..\Far Moor Lane Alders Drive T junction\20000 BIC 2017 AM Peak.vpi |
| Date Run | 23 September 2009 |
| Time Run | 14:35:29 |
| Driving Side | Drive On The Left |

Arm Names and Flow Scaling Factors

| Arm | Arm Name | Flow Scaling Factor (%) |
|-------|--------------------|-------------------------|
| Arm A | Alders Drive North | 100 |
| Arm B | Far Moor Lane | 100 |
| Arm C | Alders Drive South | 100 |

Stream Labelling Convention

Stream A-B contains traffic going from A to B etc.

Run Information

| Parameter | Values |
|-------------|--|
| Run Title | 20000 BIC 2017 Far Moor Lane_ Alders Drive AM Peak |
| Location | Redditch |
| Date | 23 September 2009 |
| Enumerator | lbates [HP24852250691] |
| Job Number | 835 |
| Status | Preliminary |
| Client | Redditch Borough Council |
| Description | - |

Errors and Warnings

| Parameter | Values |
|-----------|-----------------------|
| Warning | No Errors Or Warnings |

Geometric Data

Geometric Parameters

| Parameter | Minor Arm B |
|---|-------------|
| Major Road Carriageway Width (m) | 8.30 |
| Major Road Kerbed Central Reserve Width (m) | 0.00 |
| Major Road Right Turning Lane Width (m) | 2.20 |
| Minor Road Width 0m Back from Junction (m) | 10.00 |
| Minor Road Width 5m Back from Junction (m) | 6.50 |
| Minor Road Width 10m Back from Junction (m) | 5.25 |
| Minor Road Width 15m Back from Junction (m) | 4.50 |
| Minor Road Width 20m Back from Junction (m) | 4.00 |
| Minor Road Flare Length (veh) | 1 |
| Minor Road Visibility To Right (m) | 27 |
| Minor Road Visibility To Left (m) | 27 |
| Major Road Right Turn Visibility (m) | 50 |
| Major Road Right Turn Blocks Traffic | No |

Slope and Intercept Values

| Stream | Intercept for Stream B-A | Slope for A-B | Slope for A-C | Slope for C-A | Slope for C-B |
|--------|--------------------------|---------------|---------------|---------------|---------------|
| B-A | 459.592 | 0.075 | 0.190 | 0.120 | 0.272 |
| B-C | 589.599 | 0.081 | 0.206 | - | - |
| C-B | 602.919 | 0.210 | 0.210 | - | - |

Note: Streams may be combined in which case capacity will be adjusted
These values do not allow for any site-specific corrections

Junction Diagram

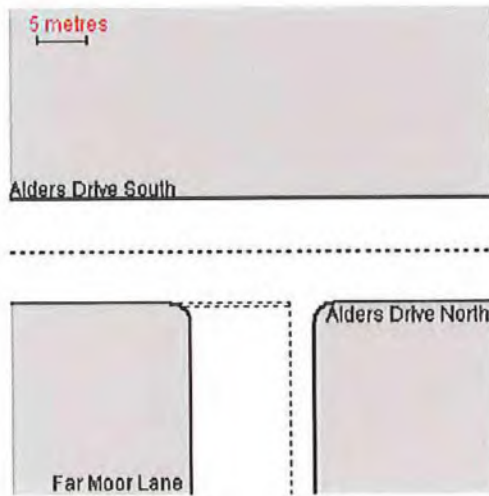

Demand Data

Modelling Periods

| Parameter | Period | Duration (min) | Segment Length (min) |
|------------------------|-------------|----------------|----------------------|
| First Modelling Period | 07:45-09:15 | 90 | 15 |

ODTAB Turning Counts

Demand Set: 2009 Far Moor Lane_ Alders Drive
 Modelling Period: 07:45-09:15

| From/To | Arm A | Arm B | Arm C |
|---------|-------|-------|-------|
| Arm A | 0.0 | 26.0 | 197.0 |
| Arm B | 35.0 | 0.0 | 281.0 |
| Arm C | 209.0 | 299.0 | 0.0 |

ODTAB Synthesised Flows

Demand Set: 2009 Far Moor Lane_ Alders Drive
Modelling Period: 07:45-09:15

| Arm | Rising Time | Rising Flow (veh/min) | Peak Time | Peak Flow (veh/min) | Falling Time | Falling Flow (veh/min) |
|-------|-------------|-----------------------|-----------|---------------------|--------------|------------------------|
| Arm A | 08:00 | 2.787 | 08:00 | 4.181 | 08:30 | 2.787 |
| Arm B | 08:00 | 3.950 | 08:00 | 5.925 | 08:30 | 3.950 |
| Arm C | 08:00 | 6.350 | 08:00 | 9.525 | 08:30 | 6.350 |

Heavy Vehicles Percentages

Demand Set: 2009 Far Moor Lane_ Alders Drive
Modelling Period: 07:45-09:15

| From/To | Arm A | Arm B | Arm C |
|---------|-------|-------|-------|
| Arm A | - | 10.0 | 10.0 |
| Arm B | 10.0 | - | 10.0 |
| Arm C | 10.0 | 10.0 | - |

Default proportions of heavy vehicles are used

Queue Diagrams

Demand Set: Sum of Demand Sets for Modelling Period: 07:45 - 09:15

Modelling Period: 07:45-09:15

View Extent: 40m

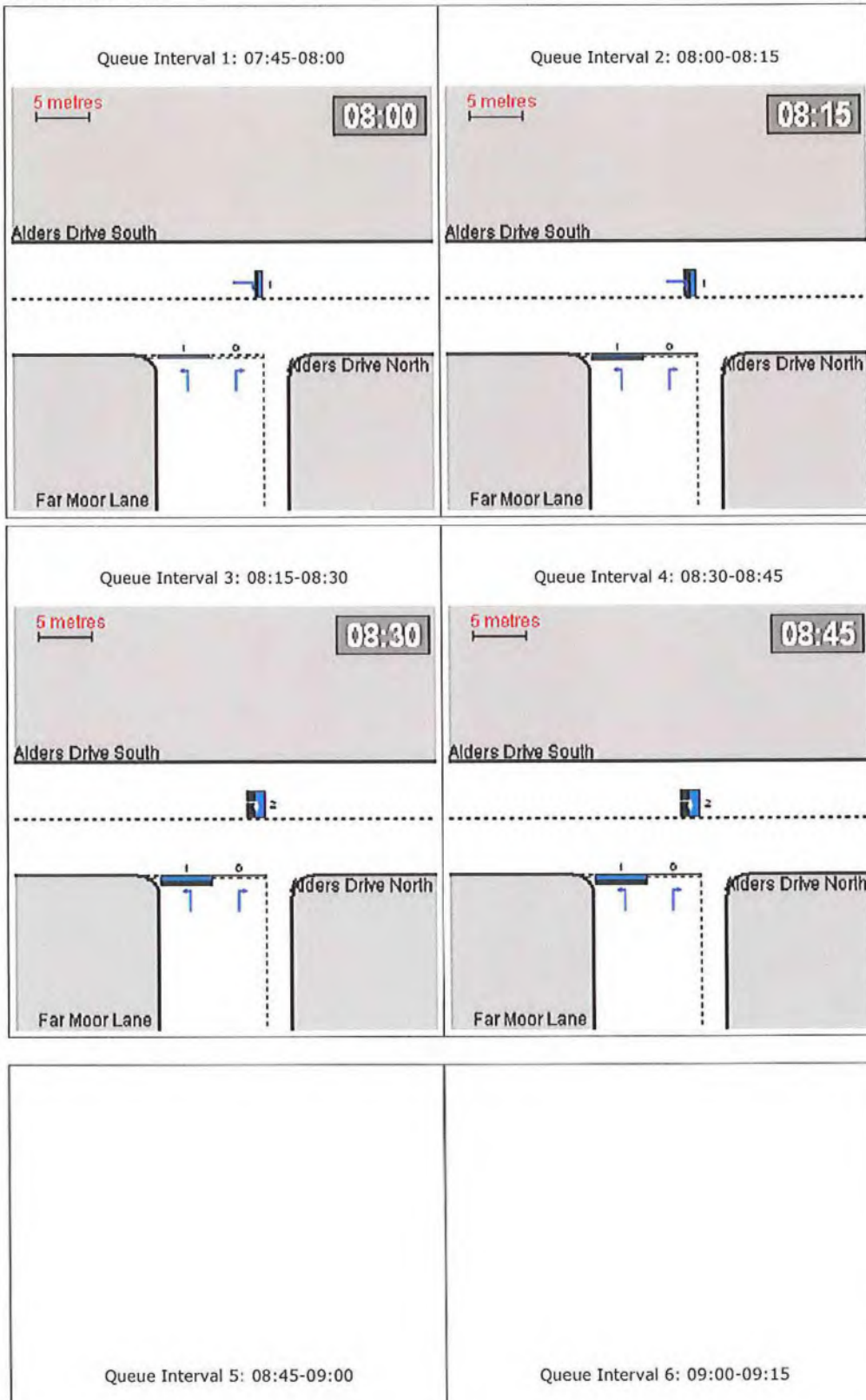

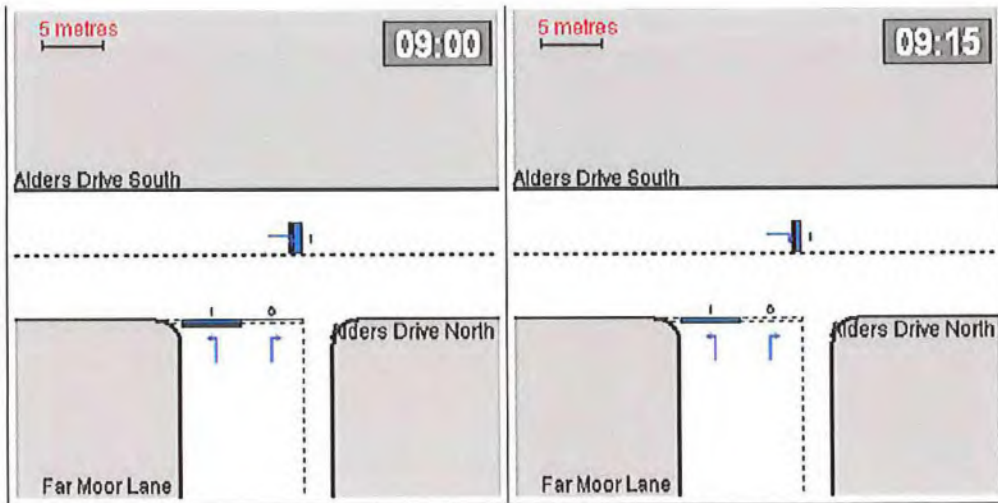

Capacity Graph

Demand Set: Sum of Demand Sets for Modelling Period: 07:45 - 09:15
Modelling Period: 07:45-09:15

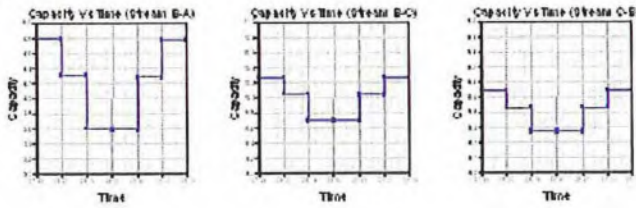

RFC Graph

Demand Set: Sum of Demand Sets for Modelling Period: 07:45 - 09:15
 Modelling Period: 07:45-09:15

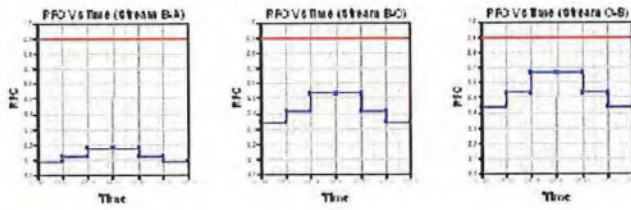

Start Queue Graph

Demand Set: Sum of Demand Sets for Modelling Period: 07:45 - 09:15
 Modelling Period: 07:45-09:15

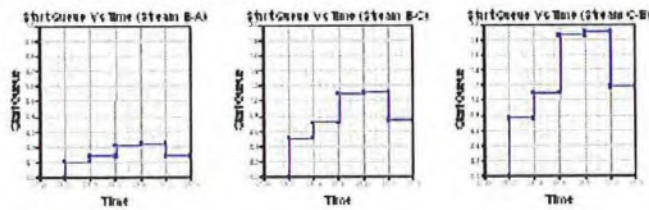

End Queue Graph

Demand Set: Sum of Demand Sets for Modelling Period: 07:45 - 09:15
 Modelling Period: 07:45-09:15

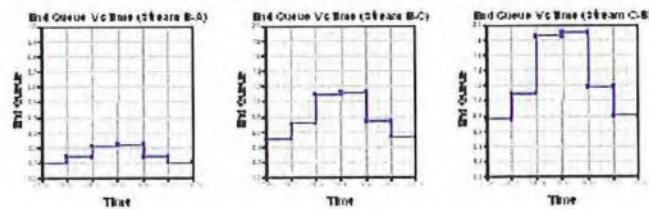

Delay Graph

Demand Set: Sum of Demand Sets for Modelling Period: 07:45 - 09:15
 Modelling Period: 07:45-09:15

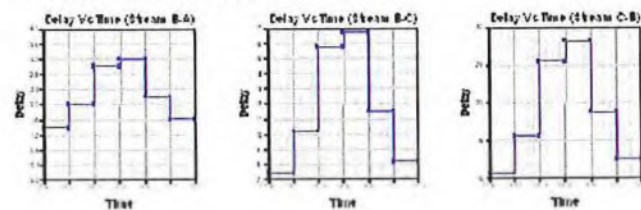

Queues & Delays

Demand Set: Sum of Demand Sets for Modelling Period: 07:45 - 09:15

Modelling Period: 07:45-09:15

| Segment | Stream | Demand (veh/min) | Capacity (veh/min) | RFC | Ped. Flow (ped/min) | Start Queue (veh) | End Queue (veh) | Geometric Delay (veh.min/segment) | Delay (veh.min/segment) | Mean Arriving Vehicle Delay (min) |
|-------------|--------|------------------|--------------------|-------|---------------------|-------------------|-----------------|-----------------------------------|-------------------------|-----------------------------------|
| 07:45-08:00 | B-A | 0.44 | 4.79 | 0.092 | - | 0.00 | 0.10 | - | 1.4 | 0.23 |
| | B-C | 3.53 | 10.27 | 0.343 | - | 0.00 | 0.51 | - | 7.4 | 0.15 |
| | C-A | 2.62 | - | - | - | - | - | - | - | - |
| | C-B | 3.75 | 8.55 | 0.439 | - | 0.00 | 0.76 | - | 10.7 | 0.20 |
| | A-B | 0.33 | - | - | - | - | - | - | - | - |
| | A-C | 2.47 | - | - | - | - | - | - | - | - |
| 08:00-08:15 | B-A | 0.52 | 4.31 | 0.122 | - | 0.10 | 0.14 | - | 2.0 | 0.26 |
| | B-C | 4.21 | 10.05 | 0.419 | - | 0.51 | 0.71 | - | 10.2 | 0.17 |
| | C-A | 3.13 | - | - | - | - | - | - | - | - |
| | C-B | 4.48 | 8.43 | 0.531 | - | 0.76 | 1.10 | - | 15.6 | 0.25 |
| | A-B | 0.39 | - | - | - | - | - | - | - | - |
| | A-C | 2.95 | - | - | - | - | - | - | - | - |
| 08:15-08:30 | B-A | 0.64 | 3.60 | 0.179 | - | 0.14 | 0.21 | - | 3.0 | 0.34 |
| | B-C | 5.16 | 9.70 | 0.531 | - | 0.71 | 1.10 | - | 15.7 | 0.22 |
| | C-A | 3.84 | - | - | - | - | - | - | - | - |
| | C-B | 5.49 | 8.27 | 0.663 | - | 1.10 | 1.85 | - | 25.5 | 0.35 |
| | A-B | 0.48 | - | - | - | - | - | - | - | - |
| | A-C | 3.62 | - | - | - | - | - | - | - | - |
| 08:30-08:45 | B-A | 0.64 | 3.58 | 0.180 | - | 0.21 | 0.22 | - | 3.2 | 0.34 |
| | B-C | 5.16 | 9.70 | 0.532 | - | 1.10 | 1.12 | - | 16.7 | 0.22 |
| | C-A | 3.84 | - | - | - | - | - | - | - | - |
| | C-B | 5.49 | 8.27 | 0.663 | - | 1.85 | 1.90 | - | 28.2 | 0.36 |
| | A-B | 0.48 | - | - | - | - | - | - | - | - |
| | A-C | 3.62 | - | - | - | - | - | - | - | - |

| Segment | Stream | Demand (veh/min) | Capacity (veh/min) | RFC | Ped. Flow (ped/min) | Start Queue (veh) | End Queue (veh) | Geometric Delay (veh.min/segment) | Delay (veh.min/segment) | Mean Arriving Vehicle Delay (min) |
|-------------|--------|------------------|--------------------|-------|---------------------|-------------------|-----------------|-----------------------------------|-------------------------|-----------------------------------|
| 08:45-09:00 | B-A | 0.52 | 4.28 | 0.122 | - | 0.22 | 0.14 | - | 2.2 | 0.27 |
| | B-C | 4.21 | 10.04 | 0.419 | - | 1.12 | 0.74 | - | 11.5 | 0.17 |
| | C-A | 3.13 | - | - | - | - | - | - | - | - |
| | C-B | 4.48 | 8.43 | 0.531 | - | 1.90 | 1.17 | - | 18.8 | 0.26 |
| | A-B | 0.39 | - | - | - | - | - | - | - | - |
| | A-C | 2.95 | - | - | - | - | - | - | - | - |

| Segment | Stream | Demand (veh/min) | Capacity (veh/min) | RFC | Ped. Flow (ped/min) | Start Queue (veh) | End Queue (veh) | Geometric Delay (veh.min/segment) | Delay (veh.min/segment) | Mean Arriving Vehicle Delay (min) |
|-------------|--------|------------------|--------------------|-------|---------------------|-------------------|-----------------|-----------------------------------|-------------------------|-----------------------------------|
| 09:00-09:15 | B-A | 0.44 | 4.76 | 0.092 | - | 0.14 | 0.10 | - | 1.6 | 0.23 |
| | B-C | 3.53 | 10.27 | 0.343 | - | 0.74 | 0.53 | - | 8.2 | 0.15 |
| | C-A | 2.62 | - | - | - | - | - | - | - | - |
| | C-B | 3.75 | 8.55 | 0.439 | - | 1.17 | 0.80 | - | 12.6 | 0.21 |
| | A-B | 0.33 | - | - | - | - | - | - | - | - |
| | A-C | 2.47 | - | - | - | - | - | - | - | - |

Entry capacities marked with an '(X)' are dominated by a pedestrian crossing in that time segment.
 In time segments marked with a '(B)', traffic leaving the junction may block back from a crossing so impairing normal operation of the junction.
 Delays marked with '###' could not be calculated.

Overall Queues & Delays

Queuing Delay Information Over Whole Period

Demand Set: Sum of Demand Sets for Modelling Period: 07:45 - 09:15
Modelling Period: 07:45-09:15

| Stream | Total Demand (veh) | Total Demand (veh/h) | Queuing Delay (min) | Queuing Delay (min/veh) | Inclusive Delay (min) | Inclusive Delay (min/veh) |
|------------|--------------------|----------------------|---------------------|-------------------------|-----------------------|---------------------------|
| B-A | 48.2 | 32.1 | 13.4 | 0.3 | 13.4 | 0.3 |
| B-C | 386.8 | 257.9 | 69.7 | 0.2 | 69.7 | 0.2 |
| C-A | 287.7 | 191.8 | - | - | - | - |
| C-B | 411.6 | 274.4 | 111.4 | 0.3 | 111.4 | 0.3 |
| A-B | 35.8 | 23.9 | - | - | - | - |
| A-C | 271.2 | 180.8 | - | - | - | - |
| All | 1441.1 | 960.7 | 194.5 | 0.1 | 194.6 | 0.1 |

Delay is that occurring only within the time period.
 Inclusive delay includes delay suffered by vehicles which are still queuing after the end of the time period.
 These will only be significantly different if there is a large queue remaining at the end of the time period.

PICADY 5 Run Successful

| PICADY | | |
|---|---|---|
| GUI Version: 5.00 AC Analysis Program Release: 3.0 INTERIM (MAR 2006) | | |
| © Copyright TRL Limited, 2006 Adapted from PICADY/3 which is Crown Copyright by permission of the controller of HMSO | | |
| For sales and distribution information, program advice and maintenance, contact: | | |
| TRL Limited Crowthorne House Nine Mile Ride Wokingham, Berks. RG40 3GA, UK |  | Tel: +44 (0)1344 770758 Fax: +44 (0)1344 770864 E-mail: softwarebureau@trl.co.uk Web: www.trlsoftware.co.uk |
| The user of this computer program for the solution of an engineering problem is in no way relieved of their responsibility for the correctness of the solution | | |

Run Analysis

| Parameter | Values |
|--------------|--|
| File Run | G:\..\Far Moor Lane Alders Drive T junction\20000 BIC 2017 PM Peak.vpi |
| Date Run | 23 September 2009 |
| Time Run | 14:33:35 |
| Driving Side | Drive On The Left |

Arm Names and Flow Scaling Factors

| Arm | Arm Name | Flow Scaling Factor (%) |
|-------|--------------------|-------------------------|
| Arm A | Alders Drive North | 100 |
| Arm B | Far Moor Lane | 100 |
| Arm C | Alders Drive South | 100 |

Stream Labelling Convention

Stream A-B contains traffic going from A to B etc.

Run Information

| Parameter | Values |
|-------------|--|
| Run Title | 20000 BIC 2017 Far Moor Lane_ Alders Drive PM Peak |
| Location | Redditch |
| Date | 23 September 2009 |
| Enumerator | lbates [HP24852250691] |
| Job Number | 835 |
| Status | Preliminary |
| Client | Redditch Borough Council |
| Description | - |

Errors and Warnings

| Parameter | Values |
|-----------|-----------------------|
| Warning | No Errors Or Warnings |

Geometric Data

Geometric Parameters

| Parameter | Minor Arm B |
|---|-------------|
| Major Road Carriageway Width (m) | 8.30 |
| Major Road Kerbed Central Reserve Width (m) | 0.00 |
| Major Road Right Turning Lane Width (m) | 2.20 |
| Minor Road Width 0m Back from Junction (m) | 10.00 |
| Minor Road Width 5m Back from Junction (m) | 6.50 |
| Minor Road Width 10m Back from Junction (m) | 5.25 |
| Minor Road Width 15m Back from Junction (m) | 4.50 |
| Minor Road Width 20m Back from Junction (m) | 4.00 |
| Minor Road Flare Length (veh) | 1 |
| Minor Road Visibility To Right (m) | 27 |
| Minor Road Visibility To Left (m) | 27 |
| Major Road Right Turn Visibility (m) | 50 |
| Major Road Right Turn Blocks Traffic | No |

Slope and Intercept Values

| Stream | Intercept for Stream B-A | Slope for A-B | Slope for A-C | Slope for C-A | Slope for C-B |
|--------|--------------------------|---------------|---------------|---------------|---------------|
| B-A | 459.592 | 0.075 | 0.190 | 0.120 | 0.272 |
| B-C | 589.599 | 0.081 | 0.206 | - | - |
| C-B | 602.919 | 0.210 | 0.210 | - | - |

Note: Streams may be combined in which case capacity will be adjusted
These values do not allow for any site-specific corrections

Junction Diagram

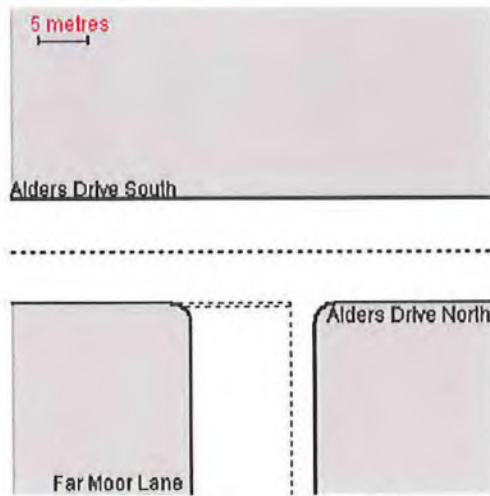

Demand Data

Modelling Periods

| Parameter | Period | Duration (min) | Segment Length (min) |
|------------------------|-------------|----------------|----------------------|
| First Modelling Period | 16:45-18:15 | 90 | 15 |

ODTAB Turning Counts

Demand Set: 2009 Far Moor Lane_ Alders Drive
Modelling Period: 16:45-18:15

| From/To | Arm A | Arm B | Arm C |
|---------|-------|-------|-------|
| Arm A | 0.0 | 24.0 | 421.0 |
| Arm B | 36.0 | 0.0 | 285.0 |
| Arm C | 478.0 | 274.0 | 0.0 |

ODTAB Synthesised Flows

Demand Set: 2009 Far Moor Lane_ Alders Drive
Modelling Period: 16:45-18:15

| Arm | Rising Time | Rising Flow (veh/min) | Peak Time | Peak Flow (veh/min) | Falling Time | Falling Flow (veh/min) |
|-------|-------------|-----------------------|-----------|---------------------|--------------|------------------------|
| Arm A | 17:00 | 5.563 | 17:00 | 8.344 | 17:30 | 5.563 |
| Arm B | 17:00 | 4.012 | 17:00 | 6.019 | 17:30 | 4.012 |
| Arm C | 17:00 | 9.400 | 17:00 | 14.100 | 17:30 | 9.400 |

Heavy Vehicles Percentages

Demand Set: 2009 Far Moor Lane_ Alders Drive
Modelling Period: 16:45-18:15

| From/To | Arm A | Arm B | Arm C |
|---------|-------|-------|-------|
| Arm A | - | 10.0 | 10.0 |
| Arm B | 10.0 | - | 10.0 |
| Arm C | 10.0 | 10.0 | - |

Default proportions of heavy vehicles are used

Queue Diagrams

Demand Set: Sum of Demand Sets for Modelling Period: 16:45 - 18:15

Modelling Period: 16:45-18:15

View Extent: 40m

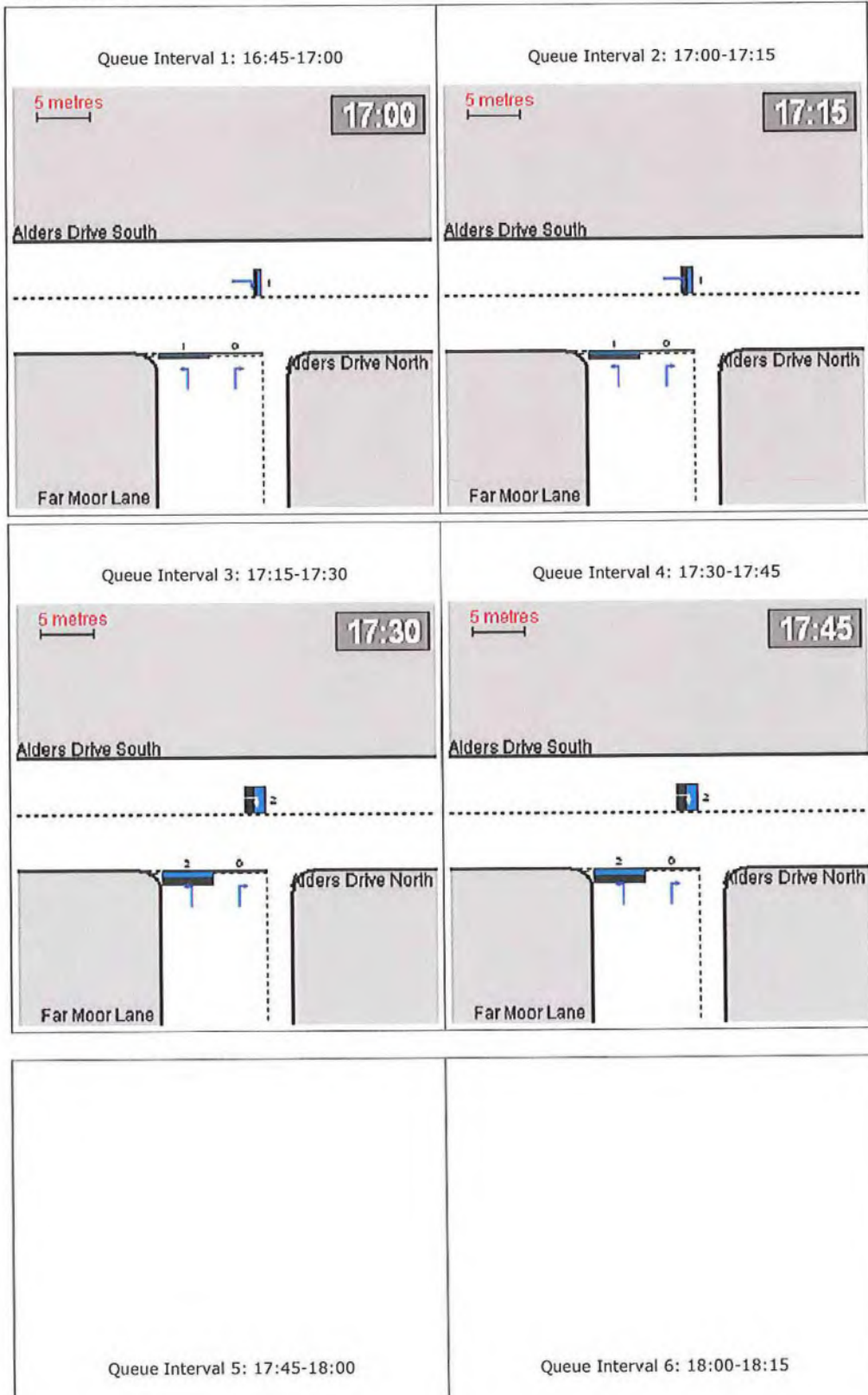

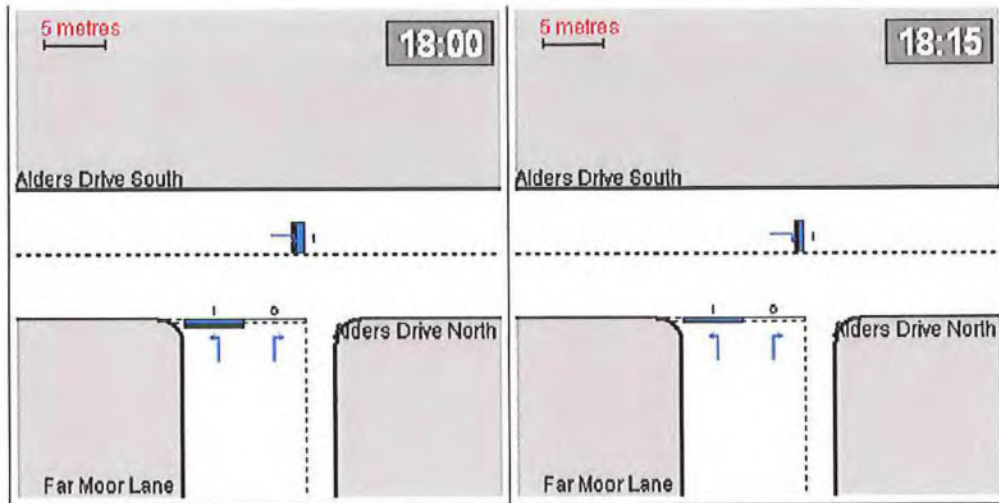

Capacity Graph

Demand Set: Sum of Demand Sets for Modelling Period: 16:45 - 18:15
Modelling Period: 16:45-18:15

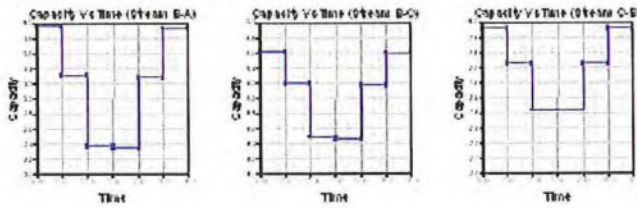

RFC Graph

Demand Set: Sum of Demand Sets for Modelling Period: 16:45 - 18:15
 Modelling Period: 16:45-18:15

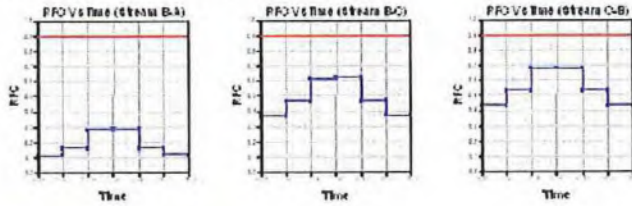

Start Queue Graph

Demand Set: Sum of Demand Sets for Modelling Period: 16:45 - 18:15
 Modelling Period: 16:45-18:15

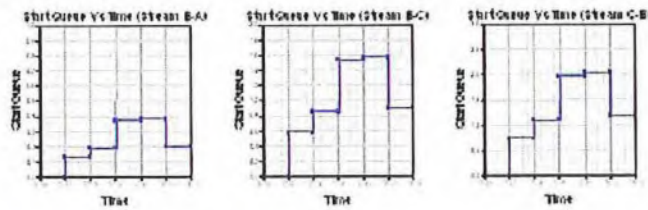

End Queue Graph

Demand Set: Sum of Demand Sets for Modelling Period: 16:45 - 18:15
 Modelling Period: 16:45-18:15

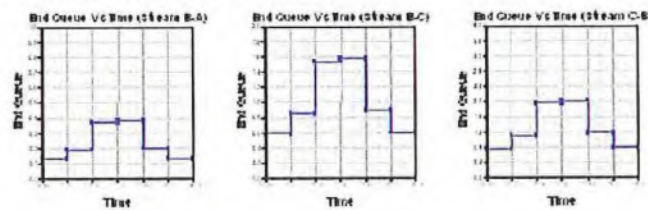

Delay Graph

Demand Set: Sum of Demand Sets for Modelling Period: 16:45 - 18:15
 Modelling Period: 16:45-18:15

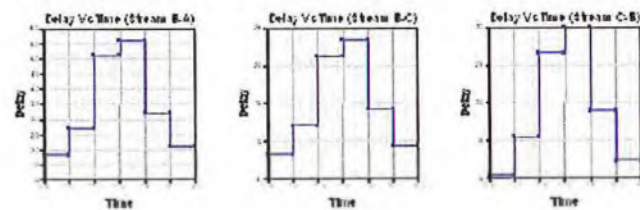

Queues & Delays

Demand Set: Sum of Demand Sets for Modelling Period: 16:45 - 18:15
 Modelling Period: 16:45-18:15

| Segment | Stream | Demand (veh/min) | Capacity (veh/min) | RFC | Ped. Flow (ped/min) | Start Queue (veh) | End Queue (veh) | Geometric Delay (veh.min/segment) | Delay (veh.min/segment) | Mean Arriving Vehicle Delay (min) |
|-------------|--------|------------------|--------------------|-------|---------------------|-------------------|-----------------|-----------------------------------|-------------------------|-----------------------------------|
| 16:45-17:00 | B-A | 0.45 | 3.96 | 0.114 | - | 0.00 | 0.13 | - | 1.8 | 0.28 |
| | B-C | 3.58 | 9.61 | 0.372 | - | 0.00 | 0.58 | - | 8.3 | 0.16 |
| | C-A | 6.00 | - | - | - | - | - | - | - | - |
| | C-B | 3.44 | 7.96 | 0.432 | - | 0.00 | 0.74 | - | 10.4 | 0.22 |
| | A-B | 0.30 | - | - | - | - | - | - | - | - |
| | A-C | 5.28 | - | - | - | - | - | - | - | - |

| Segment | Stream | Demand (veh/min) | Capacity (veh/min) | RFC | Ped. Flow (ped/min) | Start Queue (veh) | End Queue (veh) | Geometric Delay (veh.min/segment) | Delay (veh.min/segment) | Mean Arriving Vehicle Delay (min) |
|-------------|--------|------------------|--------------------|-------|---------------------|-------------------|-----------------|-----------------------------------|-------------------------|-----------------------------------|
| 17:00-17:15 | B-A | 0.54 | 3.31 | 0.163 | - | 0.13 | 0.19 | - | 2.7 | 0.36 |
| | B-C | 4.27 | 9.20 | 0.464 | - | 0.58 | 0.85 | - | 12.1 | 0.20 |
| | C-A | 7.16 | - | - | - | - | - | - | - | - |
| | C-B | 4.11 | 7.73 | 0.531 | - | 0.74 | 1.09 | - | 15.5 | 0.27 |
| | A-B | 0.36 | - | - | - | - | - | - | - | - |
| | A-C | 6.31 | - | - | - | - | - | - | - | - |

| Segment | Stream | Demand (veh/min) | Capacity (veh/min) | RFC | Ped. Flow (ped/min) | Start Queue (veh) | End Queue (veh) | Geometric Delay (veh.min/segment) | Delay (veh.min/segment) | Mean Arriving Vehicle Delay (min) |
|-------------|--------|------------------|--------------------|-------|---------------------|-------------------|-----------------|-----------------------------------|-------------------------|-----------------------------------|
| 17:15-17:30 | B-A | 0.66 | 2.37 | 0.279 | - | 0.19 | 0.37 | - | 5.1 | 0.58 |
| | B-C | 5.23 | 8.49 | 0.616 | - | 0.85 | 1.53 | - | 21.2 | 0.30 |
| | C-A | 8.77 | - | - | - | - | - | - | - | - |
| | C-B | 5.03 | 7.42 | 0.678 | - | 1.09 | 1.95 | - | 26.6 | 0.40 |
| | A-B | 0.44 | - | - | - | - | - | - | - | - |
| | A-C | 7.73 | - | - | - | - | - | - | - | - |

| Segment | Stream | Demand (veh/min) | Capacity (veh/min) | RFC | Ped. Flow (ped/min) | Start Queue (veh) | End Queue (veh) | Geometric Delay (veh.min/segment) | Delay (veh.min/segment) | Mean Arriving Vehicle Delay (min) |
|-------------|--------|------------------|--------------------|-------|---------------------|-------------------|-----------------|-----------------------------------|-------------------------|-----------------------------------|
| 17:30-17:45 | B-A | 0.66 | 2.34 | 0.282 | - | 0.37 | 0.38 | - | 5.6 | 0.59 |
| | B-C | 5.23 | 8.46 | 0.618 | - | 1.53 | 1.57 | - | 23.4 | 0.31 |
| | C-A | 8.77 | - | - | - | - | - | - | - | - |
| | C-B | 5.03 | 7.42 | 0.678 | - | 1.95 | 2.02 | - | 29.9 | 0.42 |
| | A-B | 0.44 | - | - | - | - | - | - | - | - |
| | A-C | 7.73 | - | - | - | - | - | - | - | - |

| Segment | Stream | Demand (veh/min) | Capacity (veh/min) | RFC | Ped. Flow (ped/min) | Start Queue (veh) | End Queue (veh) | Geometric Delay (veh.min/segment) | Delay (veh.min/segment) | Mean Arriving Vehicle Delay (min) |
|-------------|--------|------------------|--------------------|-------|---------------------|-------------------|-----------------|-----------------------------------|-------------------------|-----------------------------------|
| 17:45-18:00 | B-A | 0.54 | 3.28 | 0.164 | - | 0.38 | 0.20 | - | 3.2 | 0.37 |
| | B-C | 4.27 | 9.17 | 0.465 | - | 1.57 | 0.89 | - | 14.2 | 0.21 |
| | C-A | 7.16 | - | - | - | - | - | - | - | - |
| | C-B | 4.11 | 7.73 | 0.531 | - | 2.02 | 1.17 | - | 18.9 | 0.28 |
| | A-B | 0.36 | - | - | - | - | - | - | - | - |
| | A-C | 6.31 | - | - | - | - | - | - | - | - |

| Segment | Stream | Demand (veh/min) | Capacity (veh/min) | RFC | Ped. Flow (ped/min) | Start Queue (veh) | End Queue (veh) | Geometric Delay (veh.min/segment) | Delay (veh.min/segment) | Mean Arriving Vehicle Delay (min) |
|-------------|--------|------------------|--------------------|-------|---------------------|-------------------|-----------------|-----------------------------------|-------------------------|-----------------------------------|
| 18:00-18:15 | B-A | 0.45 | 3.93 | 0.115 | - | 0.20 | 0.13 | - | 2.1 | 0.29 |
| | B-C | 3.58 | 9.60 | 0.373 | - | 0.89 | 0.60 | - | 9.4 | 0.17 |
| | C-A | 6.00 | - | - | - | - | - | - | - | - |
| | C-B | 3.44 | 7.96 | 0.432 | - | 1.17 | 0.78 | - | 12.3 | 0.22 |
| | A-B | 0.30 | - | - | - | - | - | - | - | - |
| | A-C | 5.28 | - | - | - | - | - | - | - | - |

Entry capacities marked with an '(X)' are dominated by a pedestrian crossing in that time segment.

In time segments marked with a '(B)', traffic leaving the junction may block back from a crossing so impairing normal operation of the junction.

Delays marked with '##' could not be calculated.

Overall Queues & Delays

Queueing Delay Information Over Whole Period

Demand Set: Sum of Demand Sets for Modelling Period: 16:45 - 18:15

Modelling Period: 16:45-18:15

| Stream | Total Demand (veh) | Total Demand (veh/h) | Queueing Delay (min) | Queueing Delay (min/veh) | Inclusive Delay (min) | Inclusive Delay (min/veh) |
|------------|--------------------|----------------------|----------------------|--------------------------|-----------------------|---------------------------|
| B-A | 49.6 | 33.0 | 20.5 | 0.4 | 20.5 | 0.4 |
| B-C | 392.3 | 261.5 | 88.6 | 0.2 | 88.6 | 0.2 |
| C-A | 657.9 | 438.6 | - | - | - | - |
| C-B | 377.1 | 251.4 | 113.5 | 0.3 | 113.6 | 0.3 |
| A-B | 33.0 | 22.0 | - | - | - | - |
| A-C | 579.5 | 386.3 | - | - | - | - |
| All | 2089.4 | 1392.9 | 222.6 | 0.1 | 222.7 | 0.1 |

Delay is that occurring only within the time period.

Inclusive delay includes delay suffered by vehicles which are still queuing after the end of the time period.

These will only be significantly different if there is a large queue remaining at the end of the time period.

PICADY 5 Run Successful

| ARCADY 6 | | |
|--|---|---|
| GUI Version: 6.00 AD | | |
| Analysis Program: Release 4.0 (FEBRUARY 2006) | | |
| (c) Copyright TRL Limited, 2004 | | |
| Adapted from ARCADY/3 which is Crown Copyright by permission of the controller of HMSO | | |
| For sales and distribution information, program advice and maintenance, contact: | | |
| TRL Limited Crowthorne House Nine Mile Ride Wokingham, Berks. RG40 3GA, UK |  | Tel: +44 (0)1344 770018 Fax: +44 (0)1344 770864 Email: softwarebureau@trl.co.uk Web: www.trlsoftware.co.uk |
| The user of this computer program for the solution of an engineering problem is in no way relieved of their responsibility for the correctness of the solution | | |

Run Information

Run with file:- g:\MTA\13 - Job Files\13.1 Job Files\JN 835 - Redditch Borough Council\Design\PICADY\Far Moor Lane Illshaw Close Roundabout\20000 BIC 2017 AM Peak.vai

At: 15:41:12 on Wednesday, September 23, 2009

Mode: Drive On The Left

Units: Metric

Arm Labelling

| Arm | Full Arm Names |
|-------|---------------------|
| Arm A | Far Moor Lane North |
| Arm B | RBC Land |
| Arm C | Far Moor Lane South |
| Arm D | Illshaw Close |

Flow Scaling Factor

| Arm | Flow Scaling Factor (%) |
|-------|-------------------------|
| Arm A | 100 |
| Arm B | 100 |
| Arm C | 100 |
| Arm D | 100 |

File Properties

| | |
|--------------------|--------------------------|
| Run Title | 20000 BIC 2017 AM Peak |
| Location | Redditch |
| Date | 23/09/2009 |
| Client | Redditch Borough Council |
| Enumerator | lbates [HP24852250691] |
| Job Number | 835 |
| Status | |
| Description | |

Errors and Warnings

[No errors or warnings]

Geometric Data

| Data Item | Arm A | Arm B | Arm C | Arm D |
|-------------------------------|--------------|--------------|--------------|--------------|
| Approach Road Half-Width (m) | 3.60 | 4.00 | 3.60 | 2.80 |
| Entry Width (m) | 6.50 | 6.00 | 6.60 | 4.70 |
| Flare Length (m) | 3.00 | 2.80 | 3.50 | 2.00 |
| Entry Radius (m) | 17.00 | 17.30 | 16.50 | 14.00 |
| Inscribed Circle Diameter (m) | 16.80 | 16.80 | 16.80 | 16.80 |
| Entry Angle (degrees) | 20.00 | 25.50 | 19.00 | 24.00 |
| Slope | 0.599 | 0.608 | 0.606 | 0.519 |
| Intercept (PCU/Min) | 22.325 | 23.460 | 22.846 | 16.513 |

Junction Diagram: (View Extent = 40m)

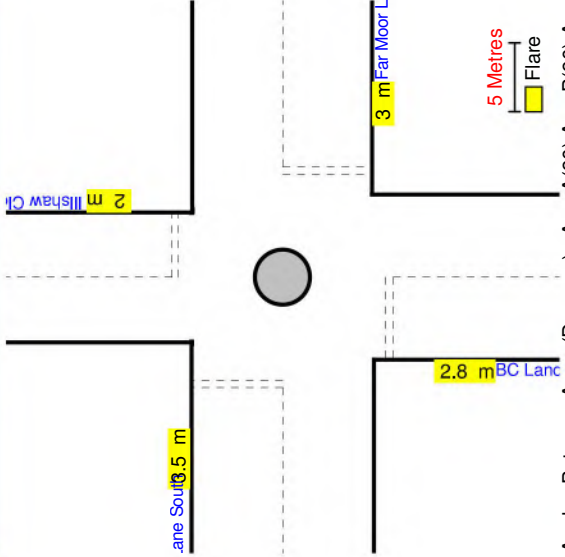

Angles Between Arms (Degrees): Arm A(90) Arm B(90) Arm C(90) Arm D(90)

Demand Data

Demand Profiles are Synthesised using **ODTAB** Data
 Period of interest (for Queue and Delay calculations): **07:45 to 09:15**
 Length of Time Period: **90 min**
 Length of Time Segment: **15 min**

Total Traffic Demand (Vehicles/Hour) for Demand Set: 20000 BIC 2017 AM Peak

| From/To | Arm A | Arm B | Arm C | Arm D |
|---------|-------|-------|-------|-------|
| Arm A | 0.0 | 205.0 | 89.0 | 7.0 |
| Arm B | 20.0 | 0.0 | 20.0 | 0.0 |
| Arm C | 191.0 | 205.0 | 0.0 | 6.0 |
| Arm D | 21.0 | 0.0 | 21.0 | 0.0 |

Entry Flow Data for Demand Set: 20000 BIC 2017 AM Peak

| Arms | Number of Minutes From Start When | | | Rate of flow (Veh/Min) | | |
|-------|-----------------------------------|------------------------|--------------------|------------------------|----------------|------------|
| | Flow Starts To Rise | Top of Peak is Reached | Flow Stops Falling | Before Peak | At Top of Peak | After Peak |
| Arm A | 15.00 | 45.00 | 75.00 | 3.76 | 5.64 | 3.76 |
| Arm B | 15.00 | 45.00 | 75.00 | 0.50 | 0.75 | 0.50 |
| Arm C | 15.00 | 45.00 | 75.00 | 5.03 | 7.54 | 5.03 |
| Arm D | 15.00 | 45.00 | 75.00 | 0.52 | 0.79 | 0.52 |

Turning Proportions

ODTAB Demand Data type is used, no turning proportions available.

Heavy Vehicle Percentages for Demand Set: 20000 BIC 2017 AM Peak

Default vehicle percentages

| Time Period | From/To | Arm A | Arm B | Arm C | Arm D |
|----------------|---------|-------|-------|-------|-------|
| 07:45 to 09:15 | Arm A | 10.0 | 10.0 | 10.0 | 10.0 |
| | Arm B | 10.0 | 10.0 | 10.0 | 10.0 |
| | Arm C | 10.0 | 10.0 | 10.0 | 10.0 |

| Time Period | From/To | Arm A | Arm B | Arm C | Arm D |
|-------------|---------|-------|-------|-------|-------|
| | Arm D | 10.0 | 10.0 | 10.0 | 10.0 |

Queue Diagrams: (View Extent = 40m)

| Queue Length | Colour |
|--------------|--------|
| Mean Queue | |
| 5 th % ile | |
| 90 th % ile | |
| 95 th % ile | |

Start Time: 07:45---> End Time: 09:15



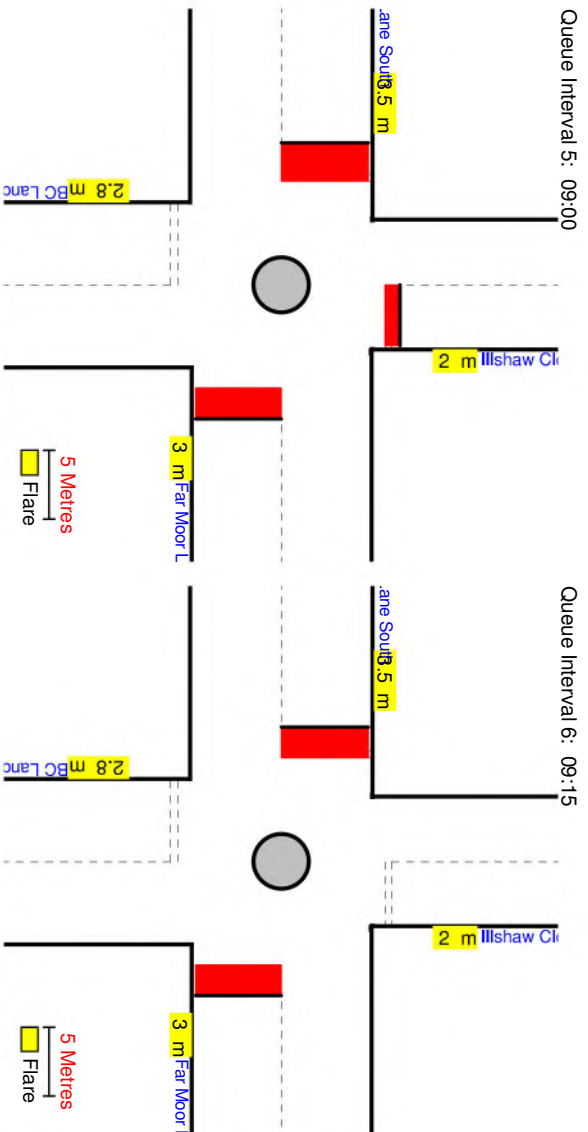

Demand Data Graphs
No graph available

Capacity (against Time) Graphs, for each 15min Interval (07:45 - 09:15)
(QUEUEING DELAY INFORMATION OVER WHOLE PERIOD)

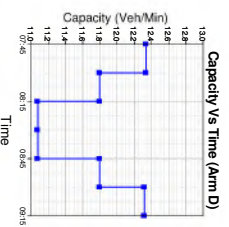
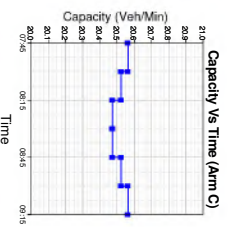
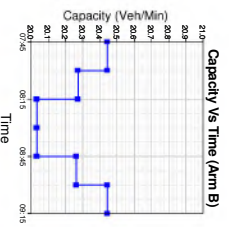
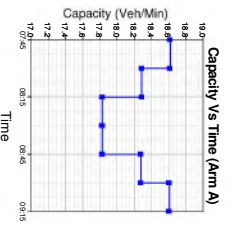

RFC (against Time) Graphs, for each 15min Interval (07:45 - 09:15)
(QUEUEING DELAY INFORMATION OVER WHOLE PERIOD)

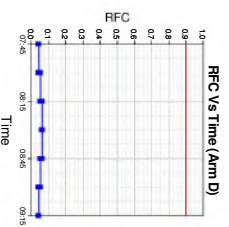
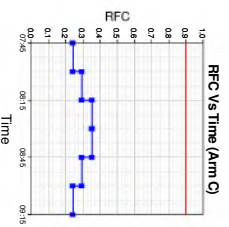
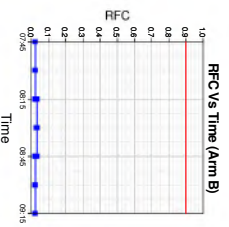
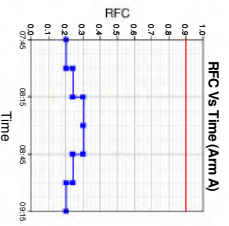

Start Queue (against Time) Graphs, for each 15min Interval (07:45 - 09:15)

(QUEUEING DELAY INFORMATION OVER WHOLE PERIOD)

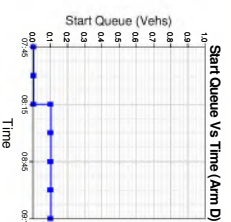
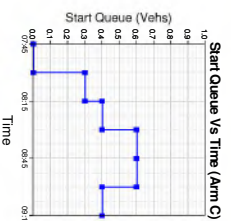
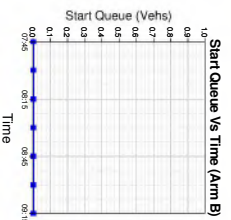
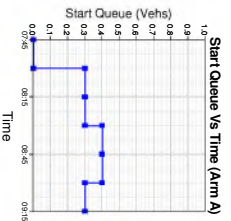

End Queue (against Time) Graphs, for each 15min Interval (07:45 - 09:15)

(QUEUEING DELAY INFORMATION OVER WHOLE PERIOD)

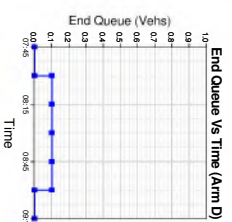
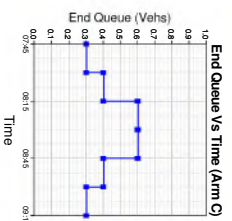
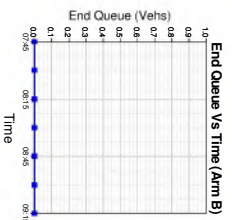
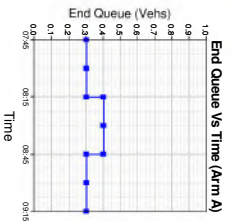

Geometric Delay Graph

No Data. Please select 'Geometric Delay' in 'Principal Options' and try again.

Delay (against Time) Graphs, for each 15min Interval (07:45 - 09:15)

(QUEUEING DELAY INFORMATION OVER WHOLE PERIOD)

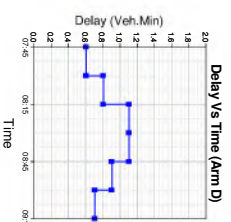
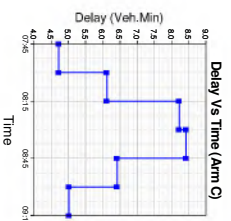
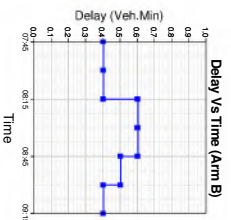
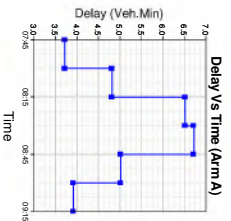

Queues and Delay:

| Segment | Arm | Demand (Veh/Min) | Capacity (Veh/Min) | Demand/Capacity (RFC) | Ped Flow (Ped/Min) | Start Queue (Veh) | End Queue (Veh) | Delay (Veh.Min/Time Segment) | Geometric Delay (Veh.Min/Time Segment) | Arrival Delay (Min/Veh) |
|-------------------------------------|-------|------------------|--------------------|-----------------------|--------------------|-------------------|-----------------|------------------------------|--|-------------------------|
| Segment : 1 - 07:45 to 08:00 | Arm A | 3.76 | 18.61 | 0.202 | - | 0.0 | 0.3 | 3.7 | - | 0.07 |
| | Arm B | 0.50 | 20.44 | 0.024 | - | 0.0 | 0.0 | 0.4 | - | 0.05 |
| | Arm C | 5.03 | 20.56 | 0.244 | - | 0.0 | 0.3 | 4.7 | - | 0.06 |
| | Arm D | 0.52 | 12.33 | 0.043 | - | 0.0 | 0.0 | 0.6 | - | 0.08 |
| Segment : 2 - 08:00 to 08:15 | Arm A | 4.49 | 18.28 | 0.246 | - | 0.3 | 0.3 | 4.8 | - | 0.07 |
| | Arm B | 0.60 | 20.27 | 0.029 | - | 0.0 | 0.0 | 0.4 | - | 0.05 |
| | Arm C | 6.00 | 20.52 | 0.292 | - | 0.3 | 0.4 | 6.1 | - | 0.07 |
| | Arm D | 0.63 | 11.79 | 0.053 | - | 0.0 | 0.1 | 0.8 | - | 0.09 |
| Segment : 3 - 08:15 to 08:30 | Arm A | 5.50 | 17.82 | 0.309 | - | 0.3 | 0.4 | 6.5 | - | 0.08 |
| | Arm B | 0.73 | 20.03 | 0.037 | - | 0.0 | 0.0 | 0.6 | - | 0.05 |
| | Arm C | 7.35 | 20.47 | 0.359 | - | 0.4 | 0.6 | 8.2 | - | 0.08 |
| | Arm D | 0.77 | 11.07 | 0.069 | - | 0.1 | 0.1 | 1.1 | - | 0.10 |
| Segment : 4 - 08:30 to 08:45 | Arm A | 5.50 | 17.82 | 0.309 | - | 0.4 | 0.4 | 6.7 | - | 0.08 |
| | Arm B | 0.73 | 20.03 | 0.037 | - | 0.0 | 0.0 | 0.6 | - | 0.05 |
| | Arm C | 7.35 | 20.47 | 0.359 | - | 0.6 | 0.6 | 8.4 | - | 0.08 |
| | Arm D | 0.77 | 11.07 | 0.069 | - | 0.1 | 0.1 | 1.1 | - | 0.10 |
| Segment : 5 - 08:45 to 09:00 | Arm A | 4.49 | 18.27 | 0.246 | - | 0.4 | 0.3 | 5.0 | - | 0.07 |
| | Arm B | 0.60 | 20.26 | 0.029 | - | 0.0 | 0.0 | 0.5 | - | 0.05 |
| | Arm C | 6.00 | 20.52 | 0.292 | - | 0.6 | 0.4 | 6.4 | - | 0.07 |
| | Arm D | 0.63 | 11.79 | 0.053 | - | 0.1 | 0.1 | 0.9 | - | 0.09 |
| Segment : 6 - 09:00 to 09:15 | Arm A | 3.76 | 18.60 | 0.202 | - | 0.3 | 0.3 | 3.9 | - | 0.07 |
| | Arm B | 0.50 | 20.44 | 0.024 | - | 0.0 | 0.0 | 0.4 | - | 0.05 |
| | Arm C | 5.03 | 20.56 | 0.244 | - | 0.4 | 0.3 | 5.0 | - | 0.06 |
| | Arm D | 0.52 | 12.31 | 0.043 | - | 0.1 | 0.0 | 0.7 | - | 0.08 |

Queuing Delay Information Over Whole Period

| Arm | Total Demand | | Queuing Delay | | Inclusive Queuing Delay | |
|------------|--------------|----------|---------------|-----------|-------------------------|-----------|
| | (Veh) | (Veh/Hr) | (Min) | (Min/Veh) | (Min) | (Min/Veh) |
| A | 412.7 | 275.2 | 30.6 | 0.07 | 30.6 | 0.07 |
| B | 54.8 | 36.6 | 2.8 | 0.05 | 2.8 | 0.05 |
| C | 551.2 | 367.5 | 38.6 | 0.07 | 38.6 | 0.07 |
| D | 57.6 | 38.4 | 5.2 | 0.09 | 5.2 | 0.09 |
| ALL | 1076.4 | 717.6 | 77.2 | 0.07 | 77.2 | 0.07 |

Delay is that occurring only within the time period.

Inclusive delay includes delay suffered by vehicles that are still queuing after the end of the time period.

These will only be significantly different if there is a large queue remaining at the end of the time period.

Accident Data

No Data, please select the 'Accident Analysis' option in 'Principal Options' and try again.

Accident Results

No Data, please select the 'Accident Analysis' option in 'Principal Options' and try again.

Errors and Warnings

| Parameter | Values |
|-----------|-----------------------|
| Warning | No Errors Or Warnings |

Geometric Data

Geometric Parameters

| Parameter | Minor Arm B | Minor Arm D |
|---|-------------|-------------|
| Major Road Carriageway Width (m) | 8.60 | 9.00 |
| Major Road Kerbed Central Reserve Width (m) | 0.00 | 0.00 |
| Major Road Right Turning Lane Width (m) | 5.00 | 3.50 |
| Minor Road Width 0m Back from Junction (m) | 10.00 | 10.00 |
| Minor Road Width 5m Back from Junction (m) | 10.00 | 4.75 |
| Minor Road Width 10m Back from Junction (m) | 6.50 | 2.50 |
| Minor Road Width 15m Back from Junction (m) | 4.50 | 2.50 |
| Minor Road Width 20m Back from Junction (m) | 3.50 | 2.50 |
| Minor Road Flare Length (veh) | 1 | 1 |
| Minor Road Visibility To Right (m) | 65 | 56 |
| Minor Road Visibility To Left (m) | 52 | 43 |
| Major Road Right Turn Visibility (m) | 200 | 200 |
| Major Road Right Turn Blocks Traffic | No | No |

Slope and Intercept Values

| Stream | Intercept for Stream B-C | Slope for A-B | Slope for A-C | Slope for A-D | Slope for B-A | Slope for B-D | Slope for C-A | Slope for C-B | Slope for C-D | Slope for D-B | Slope for D-C |
|--------|--------------------------|---------------|---------------|---------------|---------------|---------------|---------------|---------------|---------------|---------------|---------------|
| B-C | 611.605 | 0.078 | 0.198 | - | - | - | - | - | - | 0.078 | 0.198 |
| B-AD | 484.467 | 0.083 | 0.210 | - | - | - | 0.124 | 0.283 | 0.124 | 0.083 | 0.210 |
| D-A | 606.393 | 0.081 | - | - | - | - | 0.204 | - | - | 0.081 | 0.204 |
| D-BC | 484.467 | 0.120 | 0.120 | 0.273 | 0.191 | 0.076 | 0.191 | - | 0.076 | - | - |
| C-B | 899.987 | 0.309 | 0.309 | - | - | - | - | - | - | 0.309 | 0.309 |
| A-D | 899.987 | - | - | - | 0.265 | 0.265 | 0.265 | - | 0.265 | - | - |

Note: Streams may be combined in which case capacity will be adjusted
 These values do not allow for any site-specific corrections

Junction Diagram

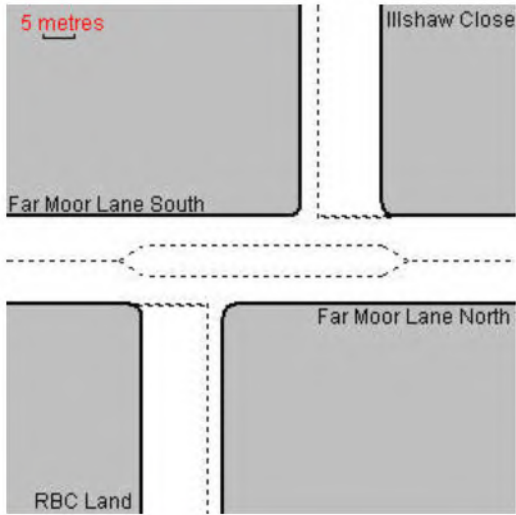

Demand Data

Modelling Periods

| Parameter | Period | Duration (min) | Segment Length (min) |
|------------------------|-------------|----------------|----------------------|
| First Modelling Period | 16:45-18:15 | 90 | 15 |

ODTAB Turning Counts

Demand Set: 20000 BIC 2017 AM Peak

Modelling Period: 16:45-18:15

| From/To | Arm A | Arm B | Arm C | Arm D |
|---------|-------|-------|-------|-------|
| Arm A | 0.0 | 25.0 | 224.0 | 15.0 |
| Arm B | 160.0 | 0.0 | 160.0 | 0.0 |
| Arm C | 119.0 | 25.0 | 0.0 | 15.0 |
| Arm D | 9.0 | 0.0 | 9.0 | 0.0 |

ODTAB Synthesised Flows

Demand Set: 20000 BIC 2017 AM Peak

Modelling Period: 16:45-18:15

| Arm | Rising Time | Rising Flow (veh/min) | Peak Time | Peak Flow (veh/min) | Falling Time | Falling Flow (veh/min) |
|-------|-------------|-----------------------|-----------|---------------------|--------------|------------------------|
| Arm A | 17:00 | 3.300 | 17:00 | 4.950 | 17:30 | 3.300 |
| Arm B | 17:00 | 4.000 | 17:00 | 6.000 | 17:30 | 4.000 |
| Arm C | 17:00 | 1.987 | 17:00 | 2.981 | 17:30 | 1.987 |
| Arm D | 17:00 | 0.225 | 17:00 | 0.337 | 17:30 | 0.225 |

Heavy Vehicles Percentages

Demand Set: 20000 BIC 2017 AM Peak

Modelling Period: 16:45-18:15

| From/To | Arm A | Arm B | Arm C | Arm D |
|---------|-------|-------|-------|-------|
| Arm A | - | 10.0 | 10.0 | 10.0 |
| Arm B | 10.0 | - | 10.0 | 10.0 |
| Arm C | 10.0 | 10.0 | - | 10.0 |
| Arm D | 10.0 | 10.0 | 10.0 | - |

Default proportions of heavy vehicles are used

Queue Diagrams

Demand Set: Sum of Demand Sets for Modelling Period: 16:45 - 18:15

Modelling Period: 16:45-18:15

View Extent: 40m

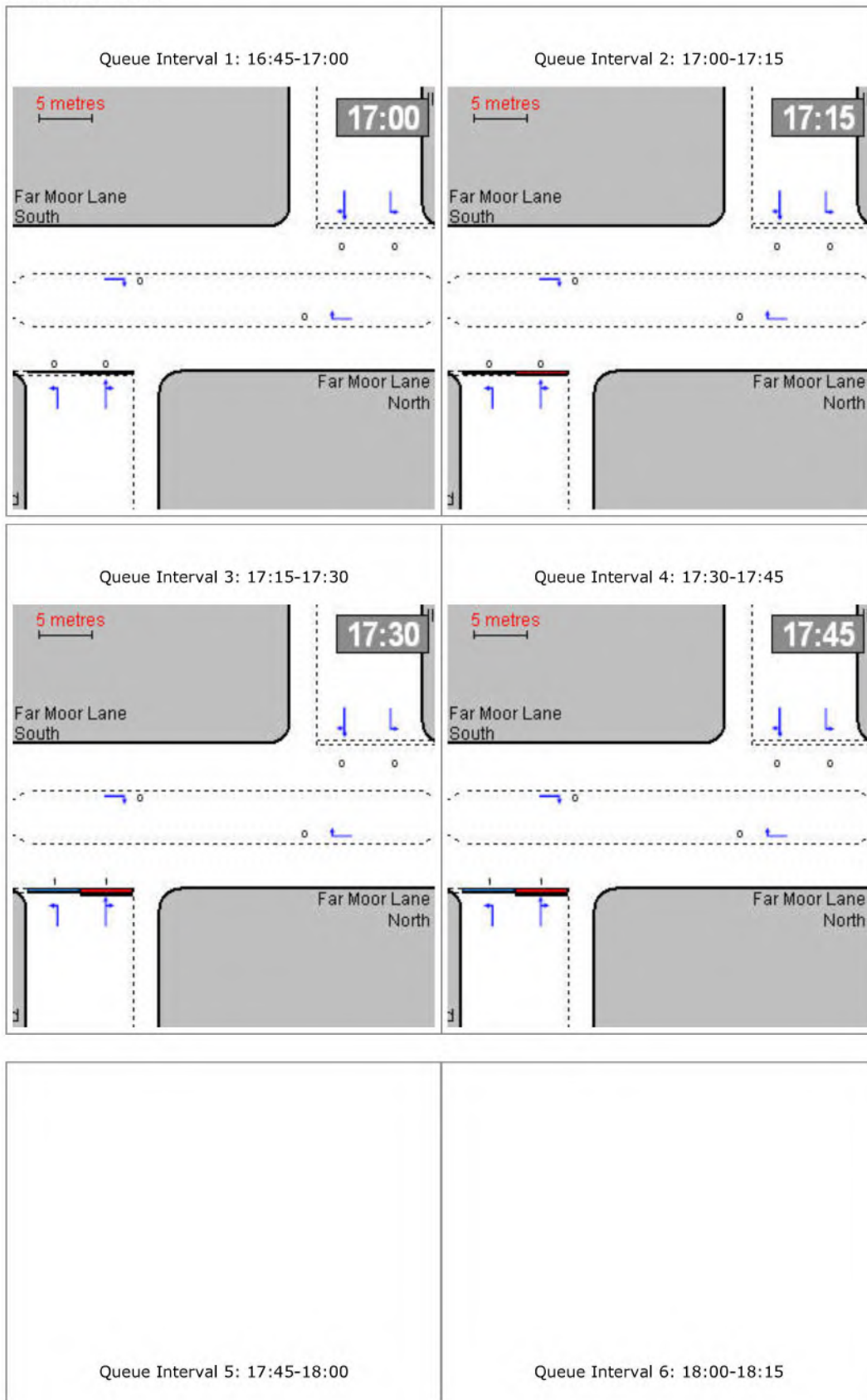

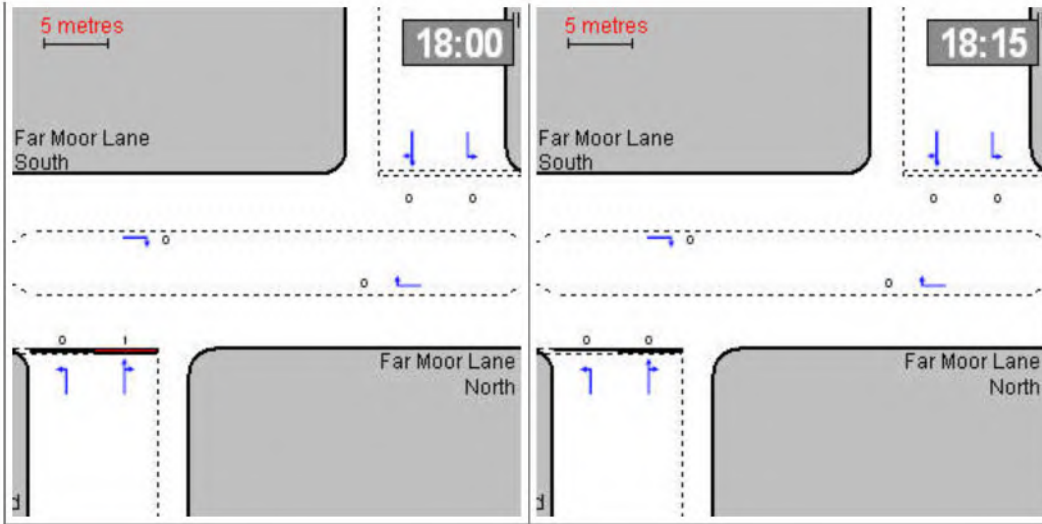

Capacity Graph

Demand Set: Sum of Demand Sets for Modelling Period: 16:45 - 18:15

Modelling Period: 16:45-18:15

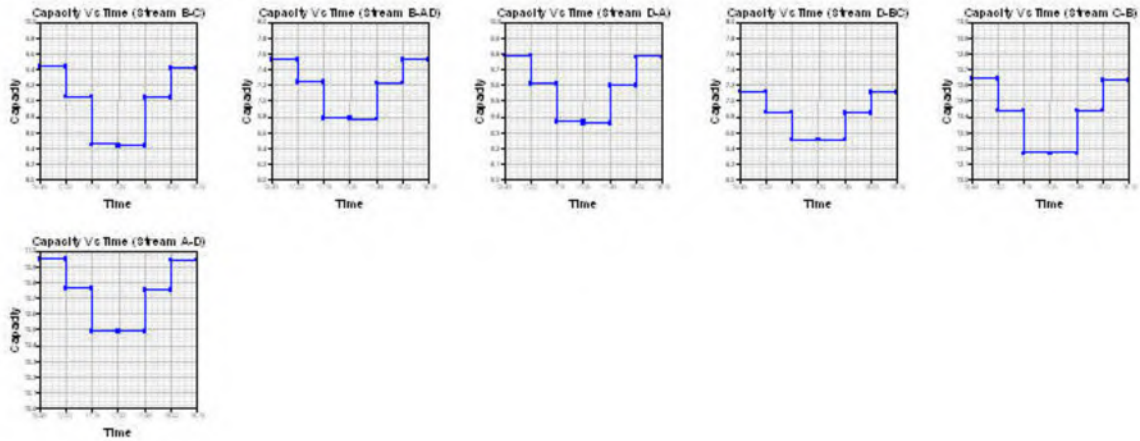

RFC Graph

Demand Set: Sum of Demand Sets for Modelling Period: 16:45 - 18:15
Modelling Period: 16:45-18:15

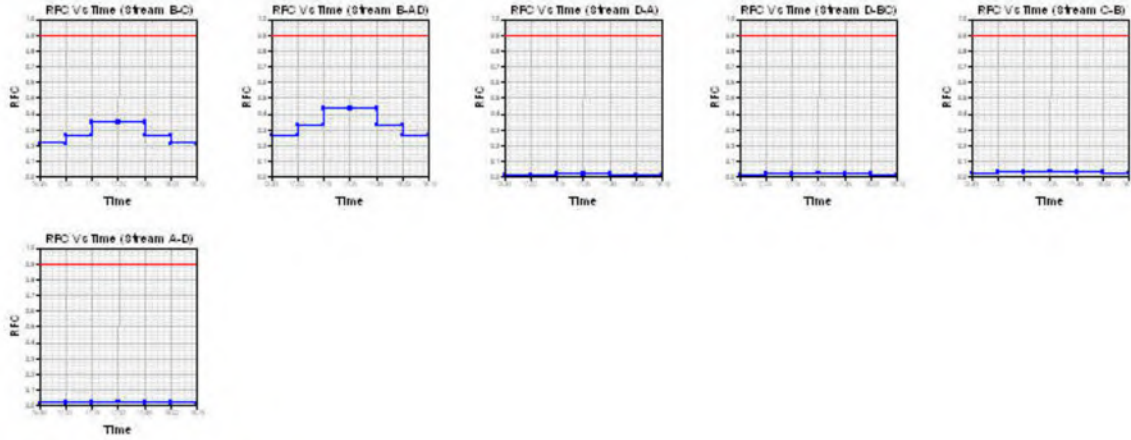

Start Queue Graph

Demand Set: Sum of Demand Sets for Modelling Period: 16:45 - 18:15
Modelling Period: 16:45-18:15

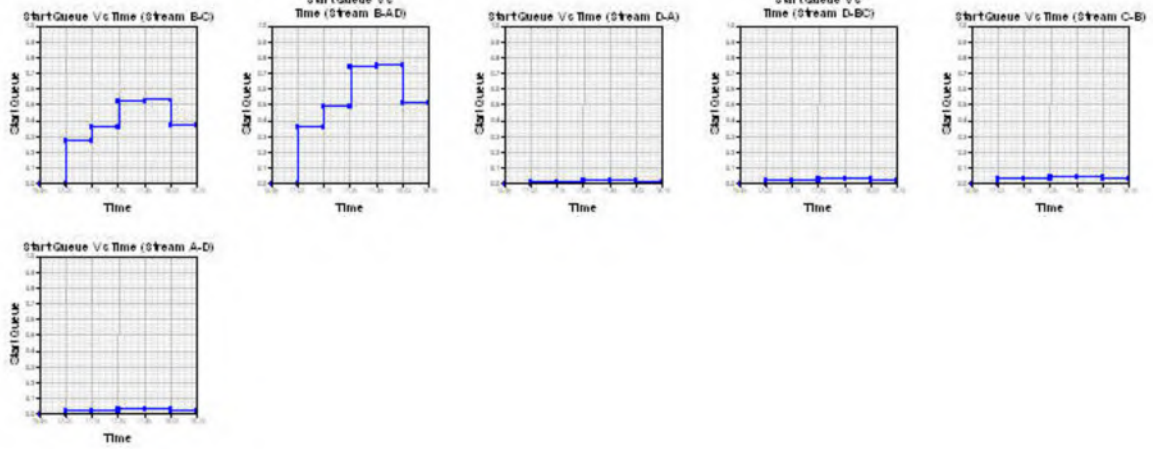

End Queue Graph

Demand Set: Sum of Demand Sets for Modelling Period: 16:45 - 18:15
Modelling Period: 16:45-18:15

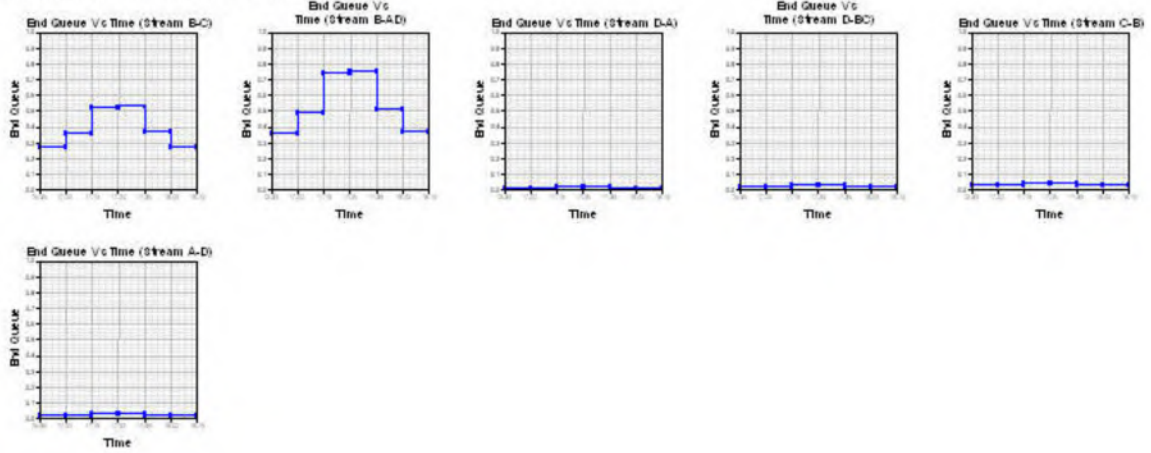

Delay Graph

Demand Set: Sum of Demand Sets for Modelling Period: 16:45 - 18:15
Modelling Period: 16:45-18:15

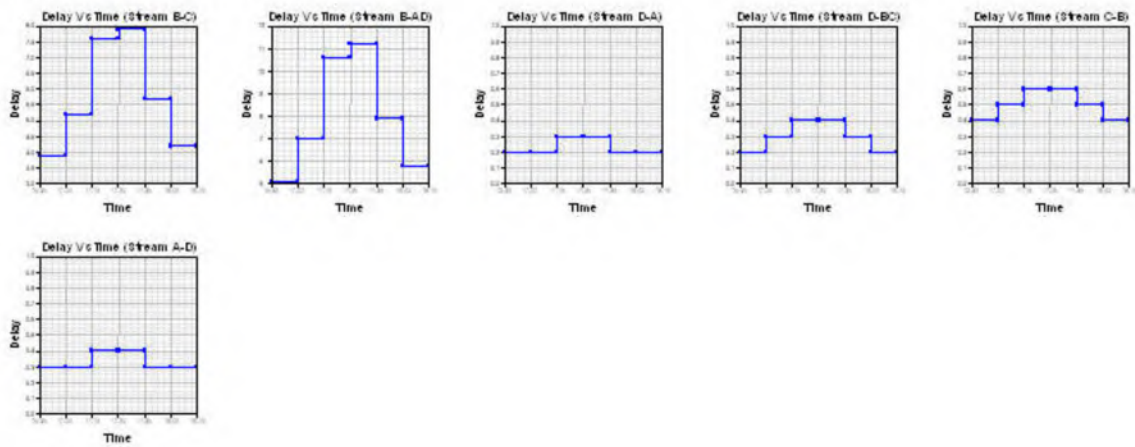

Queues & Delays

Demand Set: Sum of Demand Sets for Modelling Period: 16:45 - 18:15

Modelling Period: 16:45-18:15

| Segment | Stream | Demand (veh/min) | Capacity (veh/min) | RFC | Ped. Flow (ped/min) | Start Queue (veh) | End Queue (veh) | Geometric Delay (veh.min/segment) | Delay (veh.min/segment) | Mean Arriving Vehicle Delay (min) |
|-------------|--------|------------------|--------------------|-------|---------------------|-------------------|-----------------|-----------------------------------|-------------------------|-----------------------------------|
| 16:45-17:00 | B-C | 2.01 | 9.44 | 0.213 | - | 0.00 | 0.27 | - | 3.9 | 0.13 |
| | B-AD | 2.01 | 7.52 | 0.267 | - | 0.00 | 0.36 | - | 5.1 | 0.18 |
| | D-A | 0.11 | 9.79 | 0.012 | - | 0.00 | 0.01 | - | 0.2 | 0.10 |
| | D-BC | 0.11 | 7.12 | 0.016 | - | 0.00 | 0.02 | - | 0.2 | 0.14 |
| | C-A | 1.49 | - | - | - | - | - | - | - | - |
| | C-B | 0.31 | 12.64 | 0.025 | - | 0.00 | 0.03 | - | 0.4 | 0.08 |
| | C-D | 0.19 | - | - | - | - | - | - | - | - |
| | A-B | 0.31 | - | - | - | - | - | - | - | - |
| | A-C | 2.81 | - | - | - | - | - | - | - | - |
| A-D | 0.19 | 10.95 | 0.017 | - | 0.00 | 0.02 | - | 0.3 | 0.09 | |
| Segment | Stream | Demand (veh/min) | Capacity (veh/min) | RFC | Ped. Flow (ped/min) | Start Queue (veh) | End Queue (veh) | Geometric Delay (veh.min/segment) | Delay (veh.min/segment) | Mean Arriving Vehicle Delay (min) |
| 17:00-17:15 | B-C | 2.40 | 9.05 | 0.265 | - | 0.27 | 0.36 | - | 5.2 | 0.15 |
| | B-AD | 2.40 | 7.24 | 0.331 | - | 0.36 | 0.49 | - | 7.0 | 0.21 |
| | D-A | 0.13 | 9.61 | 0.014 | - | 0.01 | 0.01 | - | 0.2 | 0.11 |
| | D-BC | 0.13 | 6.86 | 0.020 | - | 0.02 | 0.02 | - | 0.3 | 0.15 |
| | C-A | 1.78 | - | - | - | - | - | - | - | - |
| | C-B | 0.37 | 12.44 | 0.030 | - | 0.03 | 0.03 | - | 0.5 | 0.08 |
| | C-D | 0.22 | - | - | - | - | - | - | - | - |
| | A-B | 0.37 | - | - | - | - | - | - | - | - |
| | A-C | 3.36 | - | - | - | - | - | - | - | - |
| A-D | 0.22 | 10.76 | 0.021 | - | 0.02 | 0.02 | - | 0.3 | 0.09 | |
| Segment | Stream | Demand (veh/min) | Capacity (veh/min) | RFC | Ped. Flow (ped/min) | Start Queue (veh) | End Queue (veh) | Geometric Delay (veh.min/segment) | Delay (veh.min/segment) | Mean Arriving Vehicle Delay (min) |
| 17:15-17:30 | B-C | 2.94 | 8.45 | 0.348 | - | 0.36 | 0.52 | - | 7.6 | 0.18 |
| | B-AD | 2.94 | 6.78 | 0.433 | - | 0.49 | 0.74 | - | 10.6 | 0.26 |
| | D-A | 0.17 | 9.37 | 0.018 | - | 0.01 | 0.02 | - | 0.3 | 0.11 |
| | D-BC | 0.17 | 6.51 | 0.025 | - | 0.02 | 0.03 | - | 0.4 | 0.16 |
| | C-A | 2.18 | - | - | - | - | - | - | - | - |
| | C-B | 0.46 | 12.17 | 0.038 | - | 0.03 | 0.04 | - | 0.6 | 0.09 |
| | C-D | 0.28 | - | - | - | - | - | - | - | - |
| | A-B | 0.46 | - | - | - | - | - | - | - | - |
| | A-C | 4.11 | - | - | - | - | - | - | - | - |
| A-D | 0.28 | 10.49 | 0.026 | - | 0.02 | 0.03 | - | 0.4 | 0.10 | |
| Segment | Stream | Demand (veh/min) | Capacity (veh/min) | RFC | Ped. Flow (ped/min) | Start Queue (veh) | End Queue (veh) | Geometric Delay (veh.min/segment) | Delay (veh.min/segment) | Mean Arriving Vehicle Delay (min) |
| 17:30-17:45 | B-C | 2.94 | 8.43 | 0.348 | - | 0.52 | 0.53 | - | 7.9 | 0.18 |
| | B-AD | 2.94 | 6.77 | 0.433 | - | 0.74 | 0.75 | - | 11.2 | 0.26 |
| | D-A | 0.17 | 9.36 | 0.018 | - | 0.02 | 0.02 | - | 0.3 | 0.11 |
| | D-BC | 0.17 | 6.51 | 0.025 | - | 0.03 | 0.03 | - | 0.4 | 0.16 |
| | C-A | 2.18 | - | - | - | - | - | - | - | - |
| | C-B | 0.46 | 12.17 | 0.038 | - | 0.04 | 0.04 | - | 0.6 | 0.09 |

| | C-D | 0.28 | - | - | - | - | - | - | - | - |
|-------------|--------|------------------|--------------------|-------|---------------------|-------------------|-----------------|-----------------------------------|-------------------------|-----------------------------------|
| | A-B | 0.46 | - | - | - | - | - | - | - | - |
| | A-C | 4.11 | - | - | - | - | - | - | - | - |
| | A-D | 0.28 | 10.49 | 0.026 | - | 0.03 | 0.03 | - | 0.4 | 0.10 |
| Segment | Stream | Demand (veh/min) | Capacity (veh/min) | RFC | Ped. Flow (ped/min) | Start Queue (veh) | End Queue (veh) | Geometric Delay (veh.min/segment) | Delay (veh.min/segment) | Mean Arriving Vehicle Delay (min) |
| 17:45-18:00 | B-C | 2.40 | 9.04 | 0.265 | - | 0.53 | 0.37 | - | 5.7 | 0.15 |
| | B-AD | 2.40 | 7.23 | 0.331 | - | 0.75 | 0.51 | - | 7.9 | 0.21 |
| | D-A | 0.13 | 9.60 | 0.014 | - | 0.02 | 0.01 | - | 0.2 | 0.11 |
| | D-BC | 0.13 | 6.85 | 0.020 | - | 0.03 | 0.02 | - | 0.3 | 0.15 |
| | C-A | 1.78 | - | - | - | - | - | - | - | - |
| | C-B | 0.37 | 12.44 | 0.030 | - | 0.04 | 0.03 | - | 0.5 | 0.08 |
| | C-D | 0.22 | - | - | - | - | - | - | - | - |
| | A-B | 0.37 | - | - | - | - | - | - | - | - |
| | A-C | 3.36 | - | - | - | - | - | - | - | - |
| A-D | 0.22 | 10.75 | 0.021 | - | 0.03 | 0.02 | - | 0.3 | 0.10 | |
| Segment | Stream | Demand (veh/min) | Capacity (veh/min) | RFC | Ped. Flow (ped/min) | Start Queue (veh) | End Queue (veh) | Geometric Delay (veh.min/segment) | Delay (veh.min/segment) | Mean Arriving Vehicle Delay (min) |
| 18:00-18:15 | B-C | 2.01 | 9.42 | 0.213 | - | 0.37 | 0.27 | - | 4.2 | 0.14 |
| | B-AD | 2.01 | 7.52 | 0.267 | - | 0.51 | 0.37 | - | 5.8 | 0.18 |
| | D-A | 0.11 | 9.78 | 0.012 | - | 0.01 | 0.01 | - | 0.2 | 0.10 |
| | D-BC | 0.11 | 7.11 | 0.016 | - | 0.02 | 0.02 | - | 0.2 | 0.14 |
| | C-A | 1.49 | - | - | - | - | - | - | - | - |
| | C-B | 0.31 | 12.63 | 0.025 | - | 0.03 | 0.03 | - | 0.4 | 0.08 |
| | C-D | 0.19 | - | - | - | - | - | - | - | - |
| | A-B | 0.31 | - | - | - | - | - | - | - | - |
| | A-C | 2.81 | - | - | - | - | - | - | - | - |
| | A-D | 0.19 | 10.94 | 0.017 | - | 0.02 | 0.02 | - | 0.3 | 0.09 |

Entry capacities marked with an '(X)' are dominated by a pedestrian crossing in that time segment.

In time segments marked with a '(B)', traffic leaving the junction may block back from a crossing so impairing normal operation of the junction.

Delays marked with '###' could not be calculated.

Overall Queues & Delays

Queueing Delay Information Over Whole Period

Demand Set: Sum of Demand Sets for Modelling Period: 16:45 - 18:15

Modelling Period: 16:45-18:15

| Stream | Total Demand (veh) | Total Demand (veh/h) | Queueing Delay (min) | Queueing Delay (min/veh) | Inclusive Delay (min) | Inclusive Delay (min/veh) |
|------------|--------------------|----------------------|----------------------|--------------------------|-----------------------|---------------------------|
| B-C | 220.2 | 146.8 | 34.4 | 0.2 | 34.4 | 0.2 |
| B-AD | 220.2 | 146.8 | 47.6 | 0.2 | 47.6 | 0.2 |
| D-A | 12.4 | 8.3 | 1.3 | 0.1 | 1.3 | 0.1 |
| D-BC | 12.4 | 8.3 | 1.8 | 0.1 | 1.8 | 0.1 |
| C-A | 163.8 | 109.2 | - | - | - | - |
| C-B | 34.4 | 22.9 | 2.9 | 0.1 | 2.9 | 0.1 |
| C-D | 20.6 | 13.8 | - | - | - | - |
| A-B | 34.4 | 22.9 | - | - | - | - |
| A-C | 308.3 | 205.5 | - | - | - | - |
| A-D | 20.6 | 13.8 | 2.0 | 0.1 | 2.0 | 0.1 |
| All | 1047.5 | 698.3 | 90.0 | 0.1 | 90.0 | 0.1 |

Delay is that occurring only within the time period.

Inclusive delay includes delay suffered by vehicles which are still queuing after the end of the time period.

These will only be significantly different if there is a large queue remaining at the end of the time period.

PICADY 5 Run Successful

Errors and Warnings

| Parameter | Values |
|-----------|-----------------------|
| Warning | No Errors Or Warnings |

Geometric Data

Geometric Parameters

| Parameter | Minor Arm B | Minor Arm D |
|---|-------------|-------------|
| Major Road Carriageway Width (m) | 8.60 | 9.00 |
| Major Road Kerbed Central Reserve Width (m) | 0.00 | 0.00 |
| Major Road Right Turning Lane Width (m) | 5.00 | 3.50 |
| Minor Road Width 0m Back from Junction (m) | 10.00 | 10.00 |
| Minor Road Width 5m Back from Junction (m) | 10.00 | 4.75 |
| Minor Road Width 10m Back from Junction (m) | 6.50 | 2.50 |
| Minor Road Width 15m Back from Junction (m) | 4.50 | 2.50 |
| Minor Road Width 20m Back from Junction (m) | 3.50 | 2.50 |
| Minor Road Flare Length (veh) | 1 | 1 |
| Minor Road Visibility To Right (m) | 65 | 56 |
| Minor Road Visibility To Left (m) | 52 | 43 |
| Major Road Right Turn Visibility (m) | 200 | 200 |
| Major Road Right Turn Blocks Traffic | No | No |

Slope and Intercept Values

| Stream | Intercept for Stream B-C | Slope for A-B | Slope for A-C | Slope for A-D | Slope for B-A | Slope for B-D | Slope for C-A | Slope for C-B | Slope for C-D | Slope for D-B | Slope for D-C |
|--------|--------------------------|---------------|---------------|---------------|---------------|---------------|---------------|---------------|---------------|---------------|---------------|
| B-C | 611.605 | 0.078 | 0.198 | - | - | - | - | - | - | 0.078 | 0.198 |
| B-AD | 484.467 | 0.083 | 0.210 | - | - | - | 0.124 | 0.283 | 0.124 | 0.083 | 0.210 |
| D-A | 606.393 | 0.081 | - | - | - | - | 0.204 | - | - | 0.081 | 0.204 |
| D-BC | 484.467 | 0.120 | 0.120 | 0.273 | 0.191 | 0.076 | 0.191 | - | 0.076 | - | - |
| C-B | 899.987 | 0.309 | 0.309 | - | - | - | - | - | - | 0.309 | 0.309 |
| A-D | 899.987 | - | - | - | 0.265 | 0.265 | 0.265 | - | 0.265 | - | - |

Note: Streams may be combined in which case capacity will be adjusted
 These values do not allow for any site-specific corrections

Junction Diagram

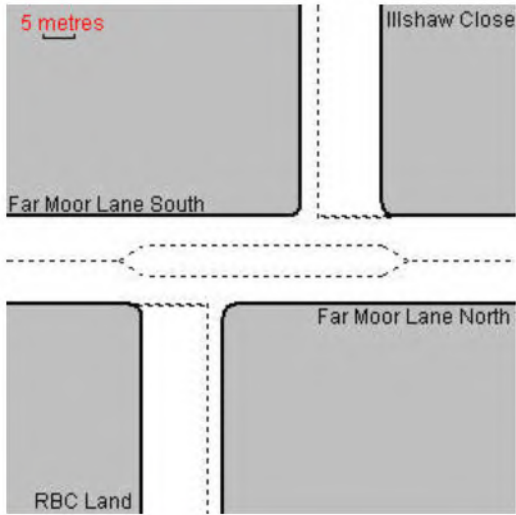

Demand Data

Modelling Periods

| Parameter | Period | Duration (min) | Segment Length (min) |
|------------------------|-------------|----------------|----------------------|
| First Modelling Period | 16:45-18:15 | 90 | 15 |

ODTAB Turning Counts

Demand Set: 20000 BIC 2017 AM Peak

Modelling Period: 16:45-18:15

| From/To | Arm A | Arm B | Arm C | Arm D |
|---------|-------|-------|-------|-------|
| Arm A | 0.0 | 25.0 | 224.0 | 15.0 |
| Arm B | 160.0 | 0.0 | 160.0 | 0.0 |
| Arm C | 119.0 | 25.0 | 0.0 | 15.0 |
| Arm D | 9.0 | 0.0 | 9.0 | 0.0 |

ODTAB Synthesised Flows

Demand Set: 20000 BIC 2017 AM Peak

Modelling Period: 16:45-18:15

| Arm | Rising Time | Rising Flow (veh/min) | Peak Time | Peak Flow (veh/min) | Falling Time | Falling Flow (veh/min) |
|-------|-------------|-----------------------|-----------|---------------------|--------------|------------------------|
| Arm A | 17:00 | 3.300 | 17:00 | 4.950 | 17:30 | 3.300 |
| Arm B | 17:00 | 4.000 | 17:00 | 6.000 | 17:30 | 4.000 |
| Arm C | 17:00 | 1.987 | 17:00 | 2.981 | 17:30 | 1.987 |
| Arm D | 17:00 | 0.225 | 17:00 | 0.337 | 17:30 | 0.225 |

Heavy Vehicles Percentages

Demand Set: 20000 BIC 2017 AM Peak

Modelling Period: 16:45-18:15

| From/To | Arm A | Arm B | Arm C | Arm D |
|---------|-------|-------|-------|-------|
| Arm A | - | 10.0 | 10.0 | 10.0 |
| Arm B | 10.0 | - | 10.0 | 10.0 |
| Arm C | 10.0 | 10.0 | - | 10.0 |
| Arm D | 10.0 | 10.0 | 10.0 | - |

Default proportions of heavy vehicles are used

Queue Diagrams

Demand Set: Sum of Demand Sets for Modelling Period: 16:45 - 18:15

Modelling Period: 16:45-18:15

View Extent: 40m

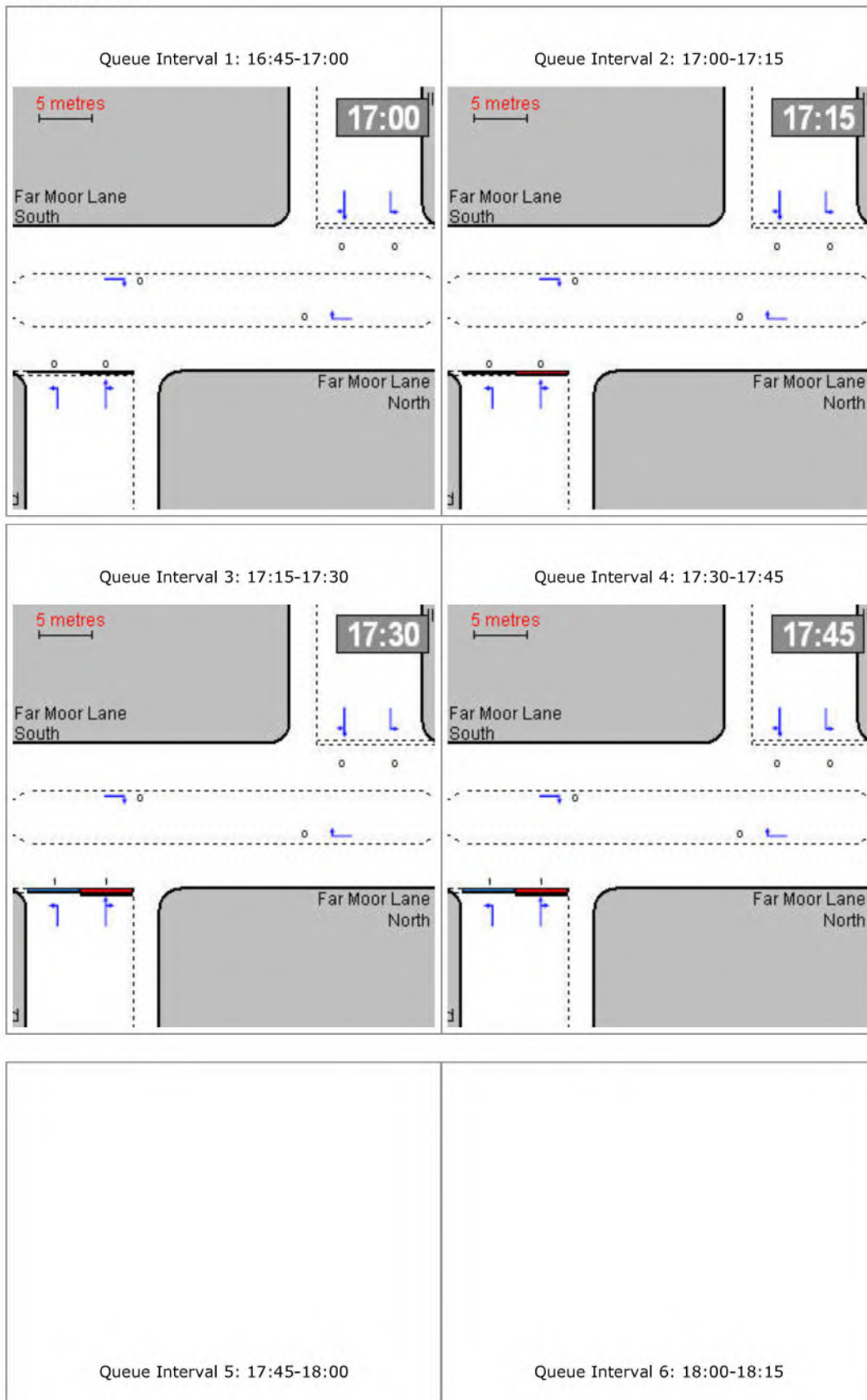

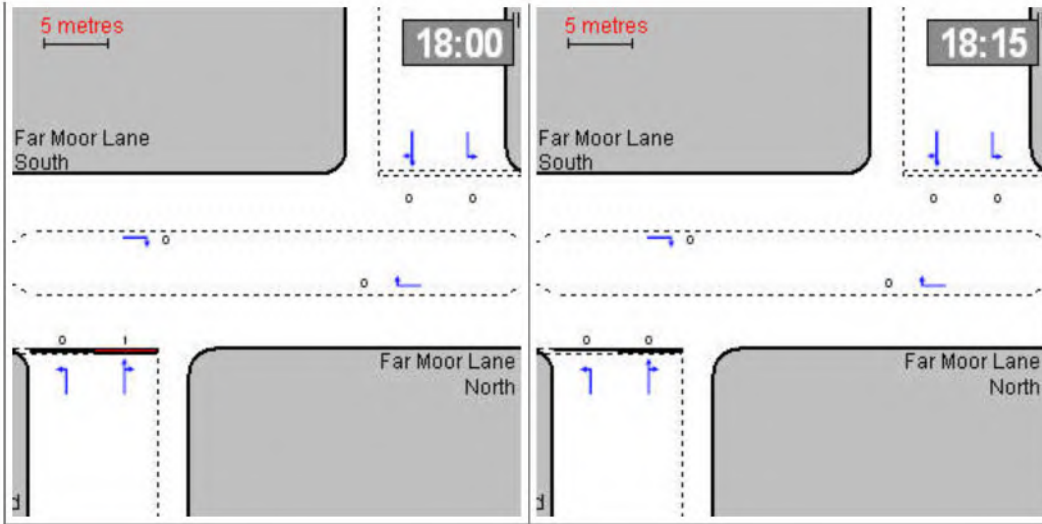

Capacity Graph

Demand Set: Sum of Demand Sets for Modelling Period: 16:45 - 18:15

Modelling Period: 16:45-18:15

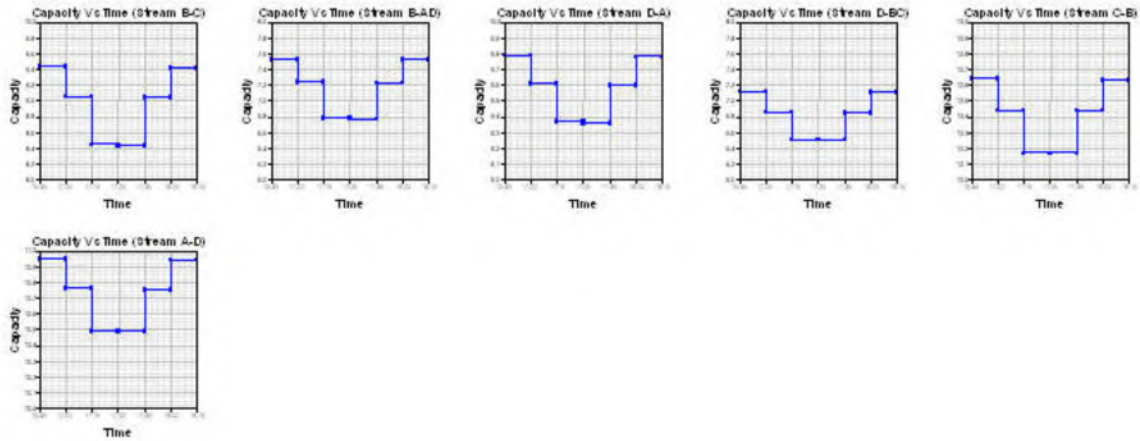

RFC Graph

Demand Set: Sum of Demand Sets for Modelling Period: 16:45 - 18:15
Modelling Period: 16:45-18:15

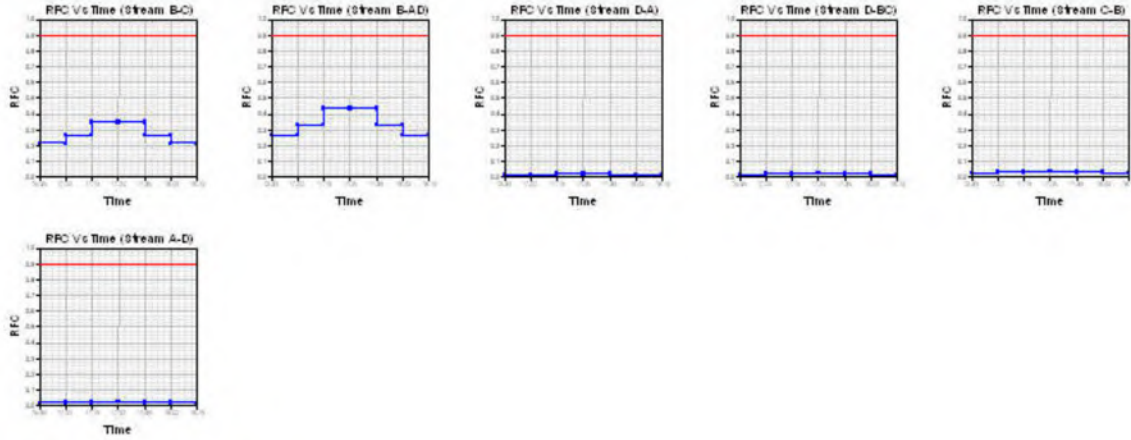

Start Queue Graph

Demand Set: Sum of Demand Sets for Modelling Period: 16:45 - 18:15
Modelling Period: 16:45-18:15

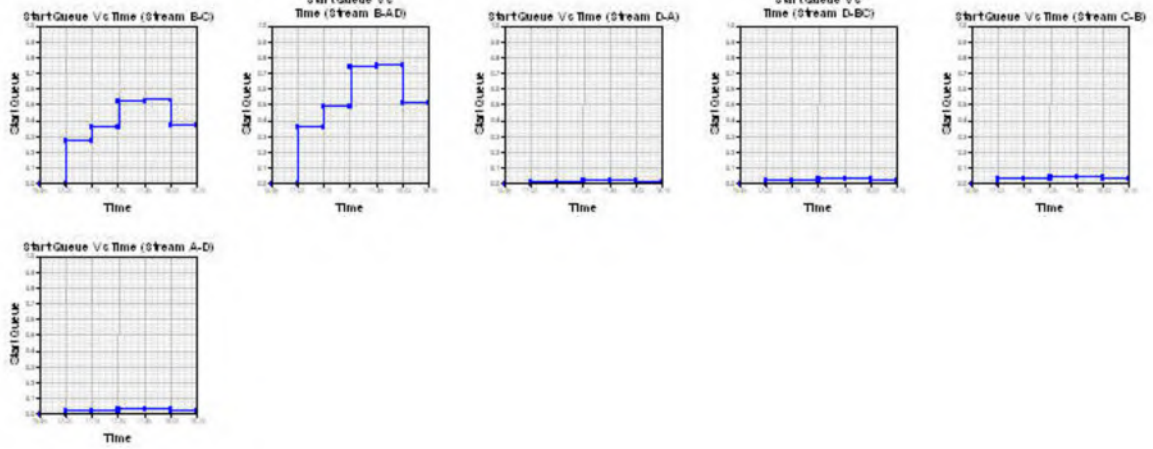

End Queue Graph

Demand Set: Sum of Demand Sets for Modelling Period: 16:45 - 18:15
Modelling Period: 16:45-18:15

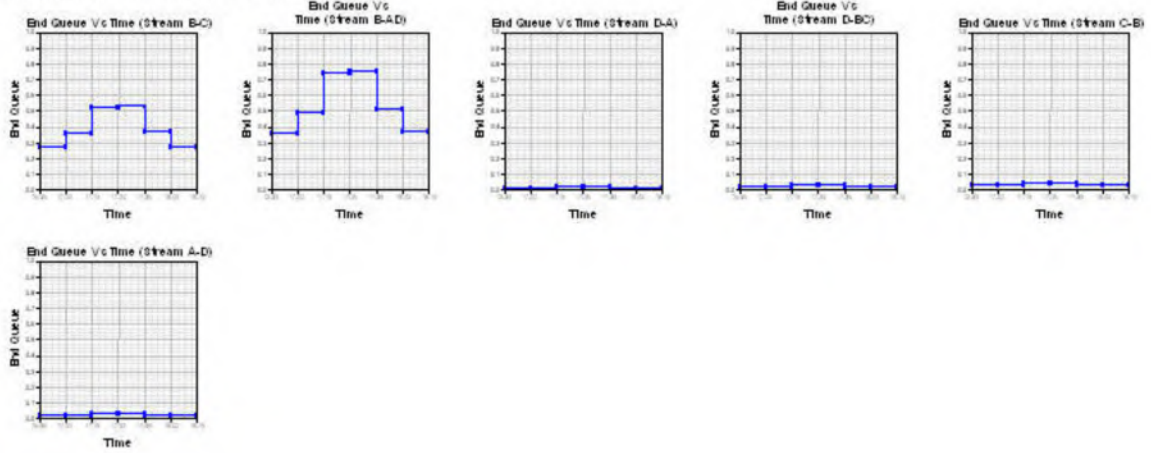

Delay Graph

Demand Set: Sum of Demand Sets for Modelling Period: 16:45 - 18:15
Modelling Period: 16:45-18:15

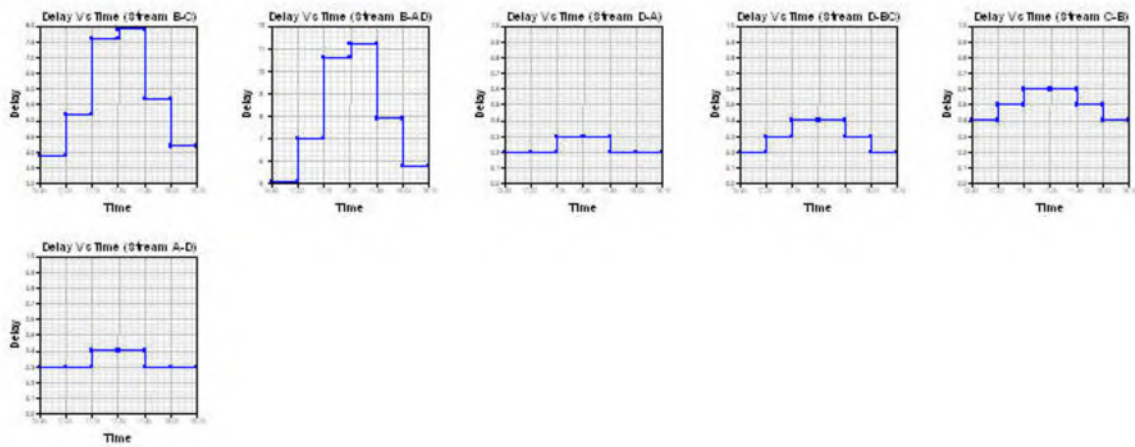

Queues & Delays

Demand Set: Sum of Demand Sets for Modelling Period: 16:45 - 18:15

Modelling Period: 16:45-18:15

| Segment | Stream | Demand (veh/min) | Capacity (veh/min) | RFC | Ped. Flow (ped/min) | Start Queue (veh) | End Queue (veh) | Geometric Delay (veh.min/segment) | Delay (veh.min/segment) | Mean Arriving Vehicle Delay (min) |
|-------------|--------|------------------|--------------------|-------|---------------------|-------------------|-----------------|-----------------------------------|-------------------------|-----------------------------------|
| 16:45-17:00 | B-C | 2.01 | 9.44 | 0.213 | - | 0.00 | 0.27 | - | 3.9 | 0.13 |
| | B-AD | 2.01 | 7.52 | 0.267 | - | 0.00 | 0.36 | - | 5.1 | 0.18 |
| | D-A | 0.11 | 9.79 | 0.012 | - | 0.00 | 0.01 | - | 0.2 | 0.10 |
| | D-BC | 0.11 | 7.12 | 0.016 | - | 0.00 | 0.02 | - | 0.2 | 0.14 |
| | C-A | 1.49 | - | - | - | - | - | - | - | - |
| | C-B | 0.31 | 12.64 | 0.025 | - | 0.00 | 0.03 | - | 0.4 | 0.08 |
| | C-D | 0.19 | - | - | - | - | - | - | - | - |
| | A-B | 0.31 | - | - | - | - | - | - | - | - |
| | A-C | 2.81 | - | - | - | - | - | - | - | - |
| A-D | 0.19 | 10.95 | 0.017 | - | 0.00 | 0.02 | - | 0.3 | 0.09 | |
| Segment | Stream | Demand (veh/min) | Capacity (veh/min) | RFC | Ped. Flow (ped/min) | Start Queue (veh) | End Queue (veh) | Geometric Delay (veh.min/segment) | Delay (veh.min/segment) | Mean Arriving Vehicle Delay (min) |
| 17:00-17:15 | B-C | 2.40 | 9.05 | 0.265 | - | 0.27 | 0.36 | - | 5.2 | 0.15 |
| | B-AD | 2.40 | 7.24 | 0.331 | - | 0.36 | 0.49 | - | 7.0 | 0.21 |
| | D-A | 0.13 | 9.61 | 0.014 | - | 0.01 | 0.01 | - | 0.2 | 0.11 |
| | D-BC | 0.13 | 6.86 | 0.020 | - | 0.02 | 0.02 | - | 0.3 | 0.15 |
| | C-A | 1.78 | - | - | - | - | - | - | - | - |
| | C-B | 0.37 | 12.44 | 0.030 | - | 0.03 | 0.03 | - | 0.5 | 0.08 |
| | C-D | 0.22 | - | - | - | - | - | - | - | - |
| | A-B | 0.37 | - | - | - | - | - | - | - | - |
| | A-C | 3.36 | - | - | - | - | - | - | - | - |
| A-D | 0.22 | 10.76 | 0.021 | - | 0.02 | 0.02 | - | 0.3 | 0.09 | |
| Segment | Stream | Demand (veh/min) | Capacity (veh/min) | RFC | Ped. Flow (ped/min) | Start Queue (veh) | End Queue (veh) | Geometric Delay (veh.min/segment) | Delay (veh.min/segment) | Mean Arriving Vehicle Delay (min) |
| 17:15-17:30 | B-C | 2.94 | 8.45 | 0.348 | - | 0.36 | 0.52 | - | 7.6 | 0.18 |
| | B-AD | 2.94 | 6.78 | 0.433 | - | 0.49 | 0.74 | - | 10.6 | 0.26 |
| | D-A | 0.17 | 9.37 | 0.018 | - | 0.01 | 0.02 | - | 0.3 | 0.11 |
| | D-BC | 0.17 | 6.51 | 0.025 | - | 0.02 | 0.03 | - | 0.4 | 0.16 |
| | C-A | 2.18 | - | - | - | - | - | - | - | - |
| | C-B | 0.46 | 12.17 | 0.038 | - | 0.03 | 0.04 | - | 0.6 | 0.09 |
| | C-D | 0.28 | - | - | - | - | - | - | - | - |
| | A-B | 0.46 | - | - | - | - | - | - | - | - |
| | A-C | 4.11 | - | - | - | - | - | - | - | - |
| A-D | 0.28 | 10.49 | 0.026 | - | 0.02 | 0.03 | - | 0.4 | 0.10 | |
| Segment | Stream | Demand (veh/min) | Capacity (veh/min) | RFC | Ped. Flow (ped/min) | Start Queue (veh) | End Queue (veh) | Geometric Delay (veh.min/segment) | Delay (veh.min/segment) | Mean Arriving Vehicle Delay (min) |
| 17:30-17:45 | B-C | 2.94 | 8.43 | 0.348 | - | 0.52 | 0.53 | - | 7.9 | 0.18 |
| | B-AD | 2.94 | 6.77 | 0.433 | - | 0.74 | 0.75 | - | 11.2 | 0.26 |
| | D-A | 0.17 | 9.36 | 0.018 | - | 0.02 | 0.02 | - | 0.3 | 0.11 |
| | D-BC | 0.17 | 6.51 | 0.025 | - | 0.03 | 0.03 | - | 0.4 | 0.16 |
| | C-A | 2.18 | - | - | - | - | - | - | - | - |
| | C-B | 0.46 | 12.17 | 0.038 | - | 0.04 | 0.04 | - | 0.6 | 0.09 |

| | C-D | 0.28 | - | - | - | - | - | - | - | - |
|-------------|--------|------------------|--------------------|-------|---------------------|-------------------|-----------------|-----------------------------------|-------------------------|-----------------------------------|
| | A-B | 0.46 | - | - | - | - | - | - | - | - |
| | A-C | 4.11 | - | - | - | - | - | - | - | - |
| | A-D | 0.28 | 10.49 | 0.026 | - | 0.03 | 0.03 | - | 0.4 | 0.10 |
| Segment | Stream | Demand (veh/min) | Capacity (veh/min) | RFC | Ped. Flow (ped/min) | Start Queue (veh) | End Queue (veh) | Geometric Delay (veh.min/segment) | Delay (veh.min/segment) | Mean Arriving Vehicle Delay (min) |
| 17:45-18:00 | B-C | 2.40 | 9.04 | 0.265 | - | 0.53 | 0.37 | - | 5.7 | 0.15 |
| | B-AD | 2.40 | 7.23 | 0.331 | - | 0.75 | 0.51 | - | 7.9 | 0.21 |
| | D-A | 0.13 | 9.60 | 0.014 | - | 0.02 | 0.01 | - | 0.2 | 0.11 |
| | D-BC | 0.13 | 6.85 | 0.020 | - | 0.03 | 0.02 | - | 0.3 | 0.15 |
| | C-A | 1.78 | - | - | - | - | - | - | - | - |
| | C-B | 0.37 | 12.44 | 0.030 | - | 0.04 | 0.03 | - | 0.5 | 0.08 |
| | C-D | 0.22 | - | - | - | - | - | - | - | - |
| | A-B | 0.37 | - | - | - | - | - | - | - | - |
| | A-C | 3.36 | - | - | - | - | - | - | - | - |
| A-D | 0.22 | 10.75 | 0.021 | - | 0.03 | 0.02 | - | 0.3 | 0.10 | |
| Segment | Stream | Demand (veh/min) | Capacity (veh/min) | RFC | Ped. Flow (ped/min) | Start Queue (veh) | End Queue (veh) | Geometric Delay (veh.min/segment) | Delay (veh.min/segment) | Mean Arriving Vehicle Delay (min) |
| 18:00-18:15 | B-C | 2.01 | 9.42 | 0.213 | - | 0.37 | 0.27 | - | 4.2 | 0.14 |
| | B-AD | 2.01 | 7.52 | 0.267 | - | 0.51 | 0.37 | - | 5.8 | 0.18 |
| | D-A | 0.11 | 9.78 | 0.012 | - | 0.01 | 0.01 | - | 0.2 | 0.10 |
| | D-BC | 0.11 | 7.11 | 0.016 | - | 0.02 | 0.02 | - | 0.2 | 0.14 |
| | C-A | 1.49 | - | - | - | - | - | - | - | - |
| | C-B | 0.31 | 12.63 | 0.025 | - | 0.03 | 0.03 | - | 0.4 | 0.08 |
| | C-D | 0.19 | - | - | - | - | - | - | - | - |
| | A-B | 0.31 | - | - | - | - | - | - | - | - |
| | A-C | 2.81 | - | - | - | - | - | - | - | - |
| | A-D | 0.19 | 10.94 | 0.017 | - | 0.02 | 0.02 | - | 0.3 | 0.09 |

Entry capacities marked with an '(X)' are dominated by a pedestrian crossing in that time segment.

In time segments marked with a '(B)', traffic leaving the junction may block back from a crossing so impairing normal operation of the junction.

Delays marked with '###' could not be calculated.

Overall Queues & Delays

Queueing Delay Information Over Whole Period

Demand Set: Sum of Demand Sets for Modelling Period: 16:45 - 18:15

Modelling Period: 16:45-18:15

| Stream | Total Demand (veh) | Total Demand (veh/h) | Queueing Delay (min) | Queueing Delay (min/veh) | Inclusive Delay (min) | Inclusive Delay (min/veh) |
|------------|--------------------|----------------------|----------------------|--------------------------|-----------------------|---------------------------|
| B-C | 220.2 | 146.8 | 34.4 | 0.2 | 34.4 | 0.2 |
| B-AD | 220.2 | 146.8 | 47.6 | 0.2 | 47.6 | 0.2 |
| D-A | 12.4 | 8.3 | 1.3 | 0.1 | 1.3 | 0.1 |
| D-BC | 12.4 | 8.3 | 1.8 | 0.1 | 1.8 | 0.1 |
| C-A | 163.8 | 109.2 | - | - | - | - |
| C-B | 34.4 | 22.9 | 2.9 | 0.1 | 2.9 | 0.1 |
| C-D | 20.6 | 13.8 | - | - | - | - |
| A-B | 34.4 | 22.9 | - | - | - | - |
| A-C | 308.3 | 205.5 | - | - | - | - |
| A-D | 20.6 | 13.8 | 2.0 | 0.1 | 2.0 | 0.1 |
| All | 1047.5 | 698.3 | 90.0 | 0.1 | 90.0 | 0.1 |

Delay is that occurring only within the time period.

Inclusive delay includes delay suffered by vehicles which are still queuing after the end of the time period.

These will only be significantly different if there is a large queue remaining at the end of the time period.

PICADY 5 Run Successful

| PICADY | | |
|--|---|---|
| GUI Version: 5.00 AC Analysis Program Release: 3.0 INTERIM (MAR 2006) | | |
| © Copyright TRL Limited, 2006 Adapted from PICADY/3 which is Crown Copyright by permission of the controller of HMSO | | |
| For sales and distribution information, program advice and maintenance, contact: | | |
| TRL Limited Crowthorne House Nine Mile Ride Wokingham, Berks. RG40 3GA, UK |  | Tel: +44 (0)1344 770758 Fax: +44 (0)1344 770864 E-mail: softwarebureau@trl.co.uk Web: www.trlsoftware.co.uk |
| The user of this computer program for the solution of an engineering problem is in no way relieved of their responsibility for the correctness of the solution | | |

Run Analysis

| Parameter | Values |
|--------------|---|
| File Run | G:\..\Far Moor Lane Illshaw Close Staggered Crossroads\20000 BIC 2017 AM Peak.vpl |
| Date Run | 23 September 2009 |
| Time Run | 16:05:27 |
| Driving Side | Drive On The Left |

Arm Names and Flow Scaling Factors

| Arm | Arm Name | Flow Scaling Factor (%) |
|-------|---------------------|-------------------------|
| Arm A | Far Moor Lane North | 100 |
| Arm B | RBC Land | 100 |
| Arm C | Far Moor Lane South | 100 |
| Arm D | Illshaw Close | 100 |

Stream Labelling Convention

Stream A-B contains traffic going from A to B etc.

Run Information

| Parameter | Values |
|-------------|--------------------------|
| Run Title | 20000 BIC 2017 AM Peak |
| Location | Redditch |
| Date | 23 September 2009 |
| Enumerator | lbates [HP24852250691] |
| Job Number | 835 |
| Status | - |
| Client | Redditch Borough Council |
| Description | - |

Errors and Warnings

| Parameter | Values |
|-----------|-----------------------|
| Warning | No Errors Or Warnings |

Geometric Data**Geometric Parameters**

| Parameter | Minor Arm B | Minor Arm D |
|---|-------------|-------------|
| Major Road Carriageway Width (m) | 8.60 | 9.00 |
| Major Road Kerbed Central Reserve Width (m) | 0.00 | 0.00 |
| Major Road Right Turning Lane Width (m) | 5.00 | 3.50 |
| Minor Road Width 0m Back from Junction (m) | 10.00 | 10.00 |
| Minor Road Width 5m Back from Junction (m) | 10.00 | 4.75 |
| Minor Road Width 10m Back from Junction (m) | 6.50 | 2.50 |
| Minor Road Width 15m Back from Junction (m) | 4.50 | 2.50 |
| Minor Road Width 20m Back from Junction (m) | 3.50 | 2.50 |
| Minor Road Flare Length (veh) | 1 | 1 |
| Minor Road Visibility To Right (m) | 65 | 56 |
| Minor Road Visibility To Left (m) | 52 | 43 |
| Major Road Right Turn Visibility (m) | 200 | 200 |
| Major Road Right Turn Blocks Traffic | No | No |

Slope and Intercept Values

| Stream | Intercept for Stream B-C | Slope for A-B | Slope for A-C | Slope for A-D | Slope for B-A | Slope for B-D | Slope for C-A | Slope for C-B | Slope for C-D | Slope for D-B | Slope for D-C |
|--------|--------------------------|---------------|---------------|---------------|---------------|---------------|---------------|---------------|---------------|---------------|---------------|
| B-C | 611.605 | 0.078 | 0.198 | - | - | - | - | - | - | 0.078 | 0.198 |
| B-AD | 484.467 | 0.083 | 0.210 | - | - | - | 0.124 | 0.283 | 0.124 | 0.083 | 0.210 |
| D-A | 606.393 | 0.081 | - | - | - | - | 0.204 | - | - | 0.081 | 0.204 |
| D-BC | 484.467 | 0.120 | 0.120 | 0.273 | 0.191 | 0.076 | 0.191 | - | 0.076 | - | - |
| C-B | 899.987 | 0.309 | 0.309 | - | - | - | - | - | - | 0.309 | 0.309 |
| A-D | 899.987 | - | - | - | 0.265 | 0.265 | 0.265 | - | 0.265 | - | - |

Note: Streams may be combined in which case capacity will be adjusted
 These values do not allow for any site-specific corrections

Junction Diagram

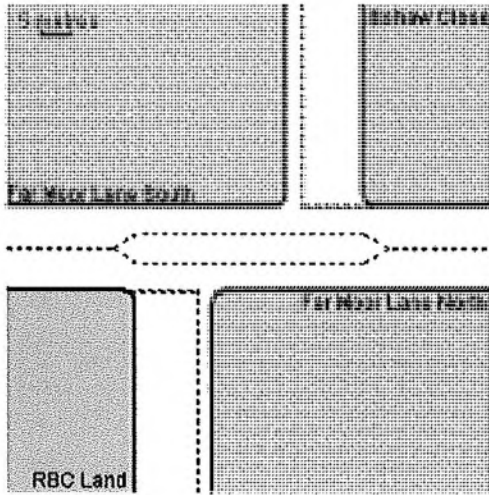

Demand Data

Modelling Periods

| Parameter | Period | Duration (min) | Segment Length (min) |
|------------------------|-------------|----------------|----------------------|
| First Modelling Period | 07:45-09:15 | 90 | 15 |

ODTAB Turning Counts

Demand Set: 20000 BIC 2017 AM Peak
Modelling Period: 07:45-09:15

| From/To | Arm A | Arm B | Arm C | Arm D |
|---------|-------|-------|-------|-------|
| Arm A | 0.0 | 205.0 | 89.0 | 7.0 |
| Arm B | 20.0 | 0.0 | 20.0 | 0.0 |
| Arm C | 191.0 | 205.0 | 0.0 | 6.0 |
| Arm D | 21.0 | 0.0 | 21.0 | 0.0 |

ODTAB Synthesised Flows

Demand Set: 20000 BIC 2017 AM Peak
Modelling Period: 07:45-09:15

| Arm | Rising Time | Rising Flow (veh/min) | Peak Time | Peak Flow (veh/min) | Falling Time | Falling Flow (veh/min) |
|-------|-------------|-----------------------|-----------|---------------------|--------------|------------------------|
| Arm A | 08:00 | 3.763 | 08:00 | 5.644 | 08:30 | 3.763 |
| Arm B | 08:00 | 0.500 | 08:00 | 0.750 | 08:30 | 0.500 |
| Arm C | 08:00 | 5.025 | 08:00 | 7.538 | 08:30 | 5.025 |
| Arm D | 08:00 | 0.525 | 08:00 | 0.787 | 08:30 | 0.525 |

Heavy Vehicles Percentages

Demand Set: 20000 BIC 2017 AM Peak
Modelling Period: 07:45-09:15

| From/To | Arm A | Arm B | Arm C | Arm D |
|---------|-------|-------|-------|-------|
| Arm A | - | 10.0 | 10.0 | 10.0 |
| Arm B | 10.0 | - | 10.0 | 10.0 |
| Arm C | 10.0 | 10.0 | - | 10.0 |
| Arm D | 10.0 | 10.0 | 10.0 | - |

Default proportions of heavy vehicles are used

Queue Diagrams

Demand Set: Sum of Demand Sets for Modelling Period: 07:45 - 09:15
Modelling Period: 07:45-09:15
View Extent: 40m

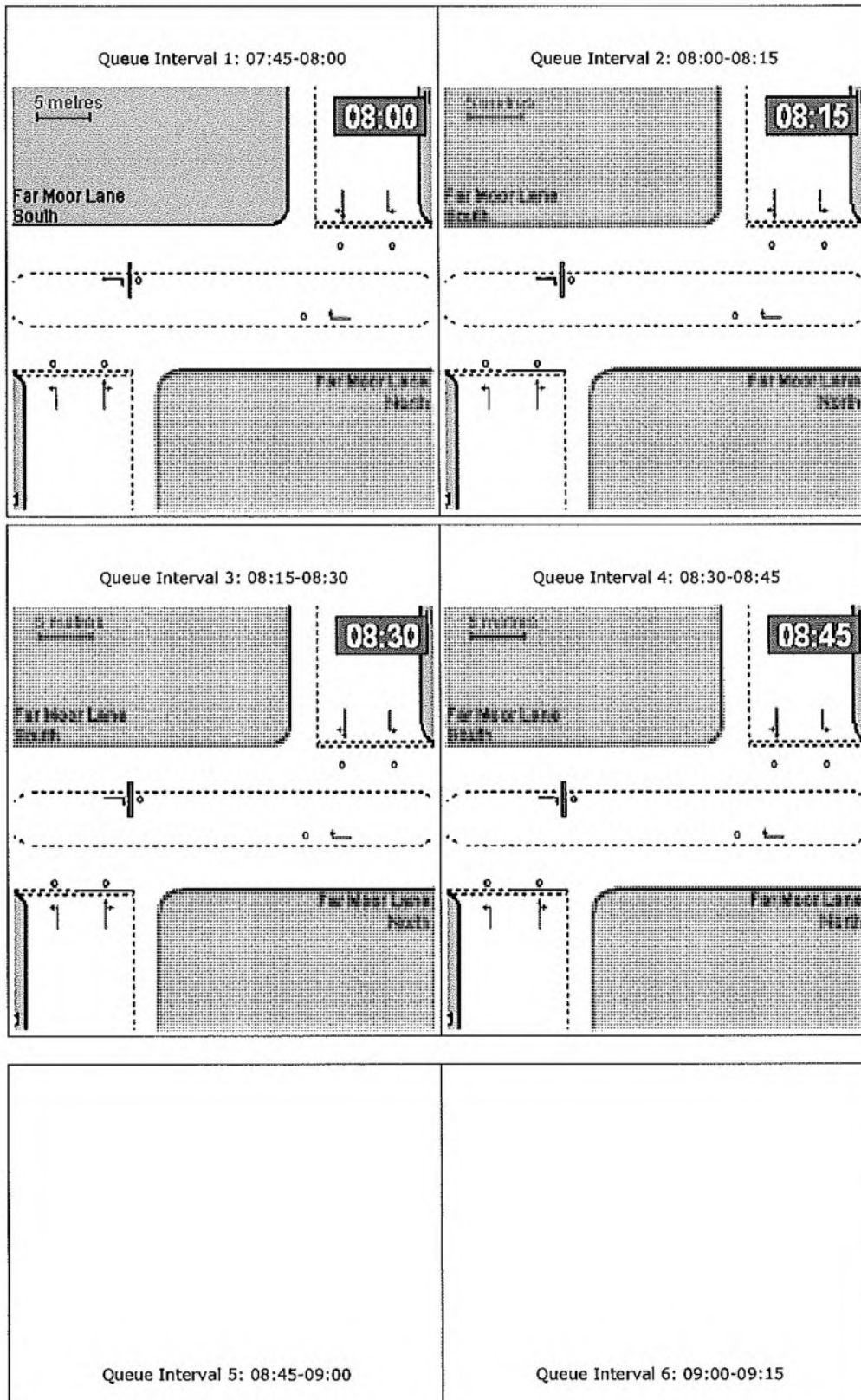

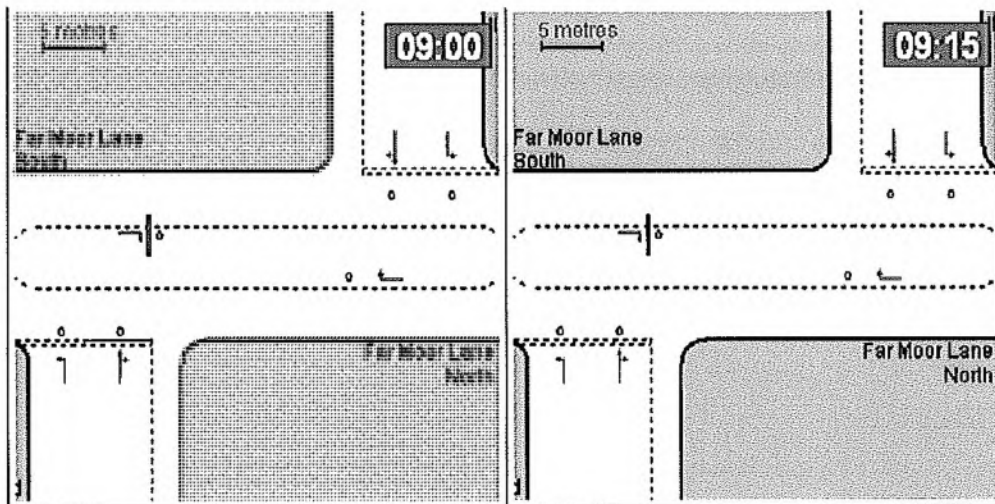

Capacity Graph

Demand Set: Sum of Demand Sets for Modelling Period: 07:45 - 09:15
 Modelling Period: 07:45-09:15

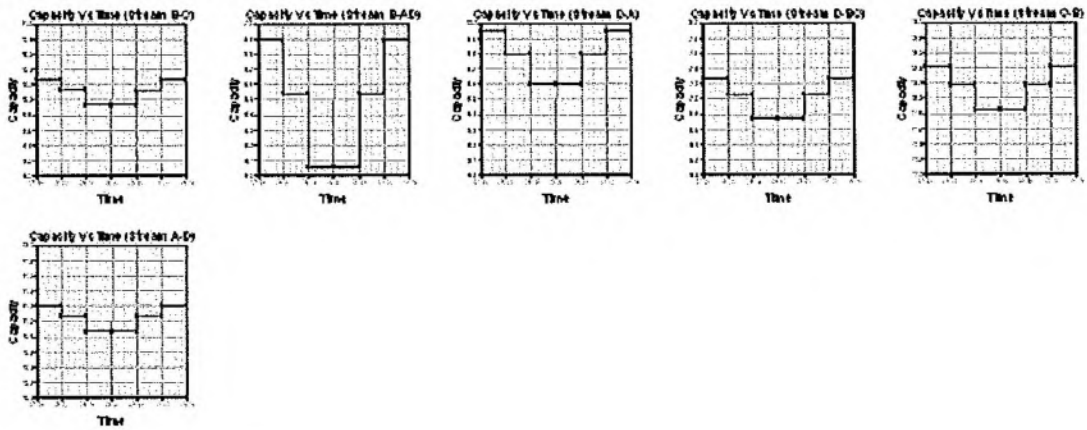

RFC Graph

Demand Set: Sum of Demand Sets for Modelling Period: 07:45 - 09:15
 Modelling Period: 07:45-09:15

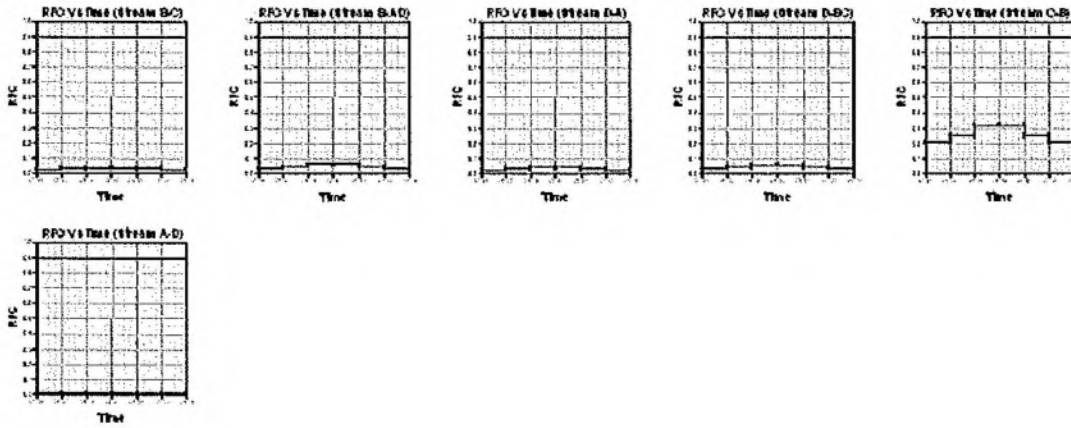

Start Queue Graph

Demand Set: Sum of Demand Sets for Modelling Period: 07:45 - 09:15
 Modelling Period: 07:45-09:15

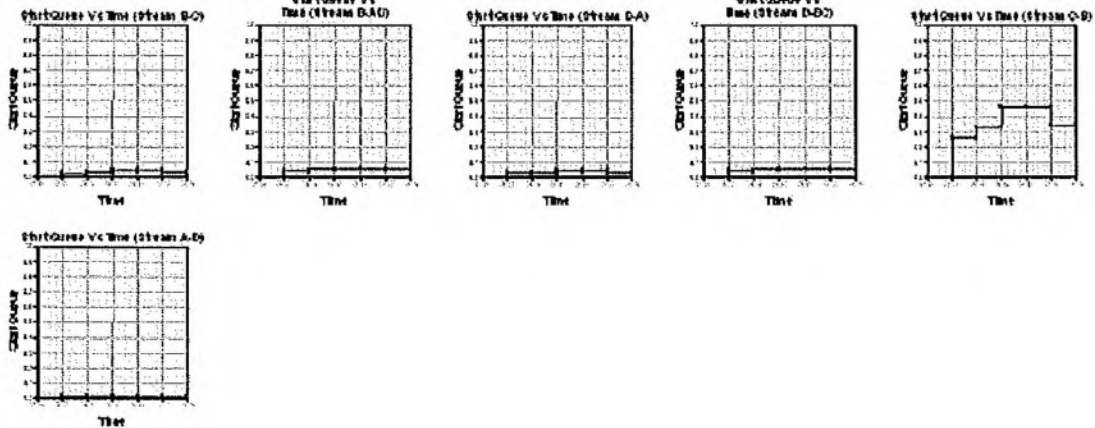

End Queue Graph

Demand Set: Sum of Demand Sets for Modelling Period: 07:45 - 09:15
 Modelling Period: 07:45-09:15

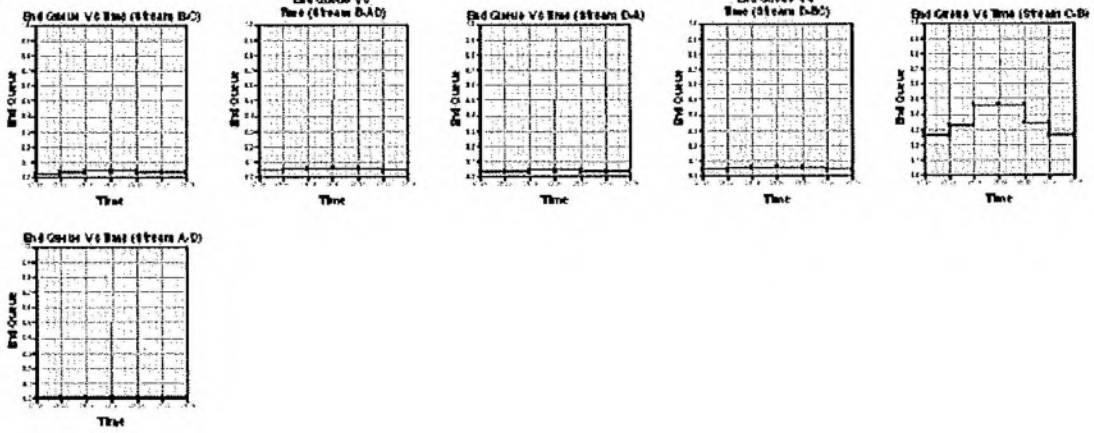

Delay Graph

Demand Set: Sum of Demand Sets for Modelling Period: 07:45 - 09:15
 Modelling Period: 07:45-09:15

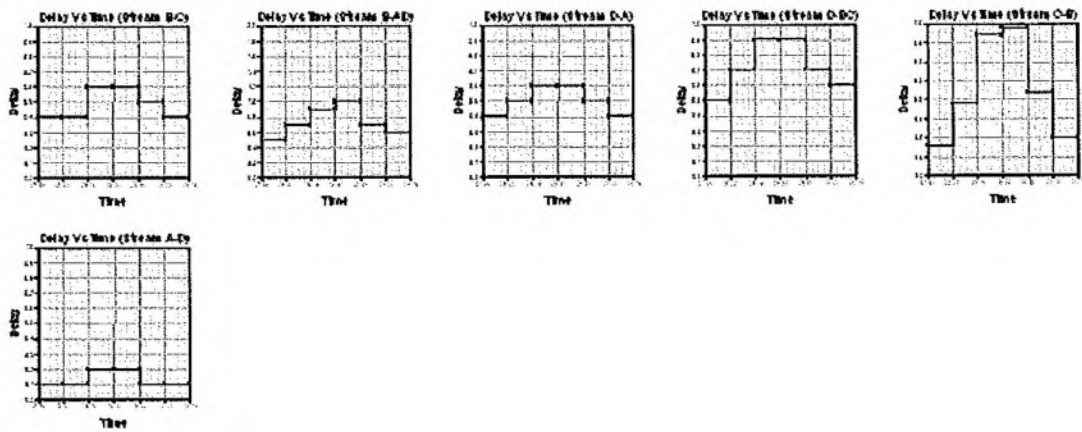

Queues & Delays

Demand Set: Sum of Demand Sets for Modelling Period: 07:45 - 09:15

Modelling Period: 07:45-09:15

| Segment | Stream | Demand (veh/min) | Capacity (veh/min) | RFC | Ped. Flow (ped/min) | Start Queue (veh) | End Queue (veh) | Geometric Delay (veh.min/segment) | Delay (veh.min/segment) | Mean Arriving Vehicle Delay (min) |
|-------------|--------|------------------|--------------------|-------|---------------------|-------------------|-----------------|-----------------------------------|-------------------------|-----------------------------------|
| 07:45-08:00 | B-C | 0.25 | 10.27 | 0.024 | - | 0.00 | 0.02 | - | 0.4 | 0.10 |
| | B-AD | 0.25 | 6.89 | 0.036 | - | 0.00 | 0.04 | - | 0.5 | 0.15 |
| | D-A | 0.26 | 9.95 | 0.026 | - | 0.00 | 0.03 | - | 0.4 | 0.10 |
| | D-BC | 0.26 | 7.27 | 0.036 | - | 0.00 | 0.04 | - | 0.5 | 0.14 |
| | C-A | 2.40 | - | - | - | - | - | - | - | - |
| | C-B | 2.57 | 12.41 | 0.207 | - | 0.00 | 0.26 | - | 3.8 | 0.10 |
| | C-D | 0.08 | - | - | - | - | - | - | - | - |
| | A-B | 2.57 | - | - | - | - | - | - | - | - |
| | A-C | 1.12 | - | - | - | - | - | - | - | - |
| A-D | 0.09 | 11.21 | 0.008 | - | 0.00 | 0.01 | - | 0.1 | 0.09 | |

| Segment | Stream | Demand (veh/min) | Capacity (veh/min) | RFC | Ped. Flow (ped/min) | Start Queue (veh) | End Queue (veh) | Geometric Delay (veh.min/segment) | Delay (veh.min/segment) | Mean Arriving Vehicle Delay (min) |
|-------------|--------|------------------|--------------------|-------|---------------------|-------------------|-----------------|-----------------------------------|-------------------------|-----------------------------------|
| 08:00-08:15 | B-C | 0.30 | 10.13 | 0.030 | - | 0.02 | 0.03 | - | 0.4 | 0.10 |
| | B-AD | 0.30 | 6.54 | 0.046 | - | 0.04 | 0.05 | - | 0.7 | 0.16 |
| | D-A | 0.31 | 9.80 | 0.032 | - | 0.03 | 0.03 | - | 0.5 | 0.11 |
| | D-BC | 0.31 | 7.05 | 0.045 | - | 0.04 | 0.05 | - | 0.7 | 0.15 |
| | C-A | 2.86 | - | - | - | - | - | - | - | - |
| | C-B | 3.07 | 12.18 | 0.252 | - | 0.26 | 0.33 | - | 4.9 | 0.11 |
| | C-D | 0.09 | - | - | - | - | - | - | - | - |
| | A-B | 3.07 | - | - | - | - | - | - | - | - |
| | A-C | 1.33 | - | - | - | - | - | - | - | - |
| A-D | 0.10 | 11.07 | 0.009 | - | 0.01 | 0.01 | - | 0.1 | 0.09 | |

| Segment | Stream | Demand (veh/min) | Capacity (veh/min) | RFC | Ped. Flow (ped/min) | Start Queue (veh) | End Queue (veh) | Geometric Delay (veh.min/segment) | Delay (veh.min/segment) | Mean Arriving Vehicle Delay (min) |
|-------------|--------|------------------|--------------------|-------|---------------------|-------------------|-----------------|-----------------------------------|-------------------------|-----------------------------------|
| 08:15-08:30 | B-C | 0.37 | 9.93 | 0.037 | - | 0.03 | 0.04 | - | 0.6 | 0.10 |
| | B-AD | 0.37 | 6.06 | 0.061 | - | 0.05 | 0.06 | - | 0.9 | 0.18 |
| | D-A | 0.39 | 9.60 | 0.040 | - | 0.03 | 0.04 | - | 0.6 | 0.11 |
| | D-BC | 0.39 | 6.74 | 0.057 | - | 0.05 | 0.06 | - | 0.9 | 0.16 |
| | C-A | 3.50 | - | - | - | - | - | - | - | - |
| | C-B | 3.76 | 11.85 | 0.318 | - | 0.33 | 0.46 | - | 6.7 | 0.12 |
| | C-D | 0.11 | - | - | - | - | - | - | - | - |
| | A-B | 3.76 | - | - | - | - | - | - | - | - |
| | A-C | 1.63 | - | - | - | - | - | - | - | - |
| A-D | 0.13 | 10.87 | 0.012 | - | 0.01 | 0.01 | - | 0.2 | 0.09 | |

| Segment | Stream | Demand (veh/min) | Capacity (veh/min) | RFC | Ped. Flow (ped/min) | Start Queue (veh) | End Queue (veh) | Geometric Delay (veh.min/segment) | Delay (veh.min/segment) | Mean Arriving Vehicle Delay (min) |
|-------------|--------|------------------|--------------------|-------|---------------------|-------------------|-----------------|-----------------------------------|-------------------------|-----------------------------------|
| 08:30-08:45 | B-C | 0.37 | 9.93 | 0.037 | - | 0.04 | 0.04 | - | 0.6 | 0.10 |
| | B-AD | 0.37 | 6.06 | 0.061 | - | 0.06 | 0.06 | - | 1.0 | 0.18 |
| | D-A | 0.39 | 9.60 | 0.040 | - | 0.04 | 0.04 | - | 0.6 | 0.11 |
| | D-BC | 0.39 | 6.74 | 0.057 | - | 0.06 | 0.06 | - | 0.9 | 0.16 |
| | C-A | 3.50 | - | - | - | - | - | - | - | - |
| | C-B | 3.76 | 11.85 | 0.318 | - | 0.46 | 0.46 | - | 6.9 | 0.12 |

| | | | | | | | | | | |
|-----|------|-------|-------|---|------|------|---|-----|------|---|
| C-D | 0.11 | - | - | - | - | - | - | - | - | - |
| A-B | 3.76 | - | - | - | - | - | - | - | - | - |
| A-C | 1.63 | - | - | - | - | - | - | - | - | - |
| A-D | 0.13 | 10.87 | 0.012 | - | 0.01 | 0.01 | - | 0.2 | 0.09 | |

| Segment | Stream | Demand (veh/min) | Capacity (veh/min) | RFC | Ped. Flow (ped/min) | Start Queue (veh) | End Queue (veh) | Geometric Delay (veh.min/segment) | Delay (veh.min/segment) | Mean Arriving Vehicle Delay (min) |
|-------------|--------|------------------|--------------------|-------|---------------------|-------------------|-----------------|-----------------------------------|-------------------------|-----------------------------------|
| 08:45-09:00 | B-C | 0.30 | 10.12 | 0.030 | - | 0.04 | 0.03 | - | 0.5 | 0.10 |
| | B-AD | 0.30 | 6.54 | 0.046 | - | 0.06 | 0.05 | - | 0.7 | 0.16 |
| | D-A | 0.31 | 9.80 | 0.032 | - | 0.04 | 0.03 | - | 0.5 | 0.11 |
| | D-BC | 0.31 | 7.05 | 0.045 | - | 0.06 | 0.05 | - | 0.7 | 0.15 |
| | C-A | 2.86 | - | - | - | - | - | - | - | - |
| | C-B | 3.07 | 12.18 | 0.252 | - | 0.46 | 0.34 | - | 5.2 | 0.11 |
| | C-D | 0.09 | - | - | - | - | - | - | - | - |
| | A-B | 3.07 | - | - | - | - | - | - | - | - |
| | A-C | 1.33 | - | - | - | - | - | - | - | - |
| A-D | 0.10 | 11.07 | 0.009 | - | 0.01 | 0.01 | - | 0.1 | 0.09 | |

| Segment | Stream | Demand (veh/min) | Capacity (veh/min) | RFC | Ped. Flow (ped/min) | Start Queue (veh) | End Queue (veh) | Geometric Delay (veh.min/segment) | Delay (veh.min/segment) | Mean Arriving Vehicle Delay (min) |
|-------------|--------|------------------|--------------------|-------|---------------------|-------------------|-----------------|-----------------------------------|-------------------------|-----------------------------------|
| 09:00-09:15 | B-C | 0.25 | 10.26 | 0.024 | - | 0.03 | 0.03 | - | 0.4 | 0.10 |
| | B-AD | 0.25 | 6.89 | 0.036 | - | 0.05 | 0.04 | - | 0.6 | 0.15 |
| | D-A | 0.26 | 9.95 | 0.026 | - | 0.03 | 0.03 | - | 0.4 | 0.10 |
| | D-BC | 0.26 | 7.27 | 0.036 | - | 0.05 | 0.04 | - | 0.6 | 0.14 |
| | C-A | 2.40 | - | - | - | - | - | - | - | - |
| | C-B | 2.57 | 12.41 | 0.207 | - | 0.34 | 0.26 | - | 4.0 | 0.10 |
| | C-D | 0.08 | - | - | - | - | - | - | - | - |
| | A-B | 2.57 | - | - | - | - | - | - | - | - |
| | A-C | 1.12 | - | - | - | - | - | - | - | - |
| A-D | 0.09 | 11.21 | 0.008 | - | 0.01 | 0.01 | - | 0.1 | 0.09 | |

Entry capacities marked with an '(X)' are dominated by a pedestrian crossing in that time segment.
 In time segments marked with a '(B)', traffic leaving the junction may block back from a crossing so impairing normal operation of the junction.
 Delays marked with '###' could not be calculated.

Overall Queues & Delays

Queueing Delay Information Over Whole Period

Demand Set: Sum of Demand Sets for Modelling Period: 07:45 - 09:15

Modelling Period: 07:45-09:15

| Stream | Total Demand (veh) | Total Demand (veh/h) | Queueing Delay (min) | Queueing Delay (min/veh) | Inclusive Delay (min) | Inclusive Delay (min/veh) |
|------------|--------------------|----------------------|----------------------|--------------------------|-----------------------|---------------------------|
| B-C | 27.5 | 18.4 | 2.8 | 0.1 | 2.8 | 0.1 |
| B-AD | 27.5 | 18.4 | 4.5 | 0.2 | 4.5 | 0.2 |
| D-A | 28.9 | 19.3 | 3.0 | 0.1 | 3.0 | 0.1 |
| D-BC | 28.9 | 19.3 | 4.3 | 0.1 | 4.3 | 0.1 |
| C-A | 262.9 | 175.3 | - | - | - | - |
| C-B | 282.2 | 188.1 | 31.6 | 0.1 | 31.6 | 0.1 |
| C-D | 8.3 | 5.5 | - | - | - | - |
| A-B | 282.2 | 188.1 | - | - | - | - |
| A-C | 122.5 | 81.7 | - | - | - | - |
| A-D | 9.6 | 6.4 | 0.9 | 0.1 | 0.9 | 0.1 |
| All | 1080.5 | 720.3 | 47.1 | 0.0 | 47.1 | 0.0 |

Delay is that occurring only within the time period.

Inclusive delay includes delay suffered by vehicles which are still queuing after the end of the time period.

These will only be significantly different if there is a large queue remaining at the end of the time period.

PICADY 5 Run Successful

| PICADY | | |
|--|---|---|
| GUI Version: 5.00 AC Analysis Program Release: 3.0 INTERIM (MAR 2006) | | |
| © Copyright TRL Limited, 2006 Adapted from PICADY/3 which is Crown Copyright by permission of the controller of HMSO | | |
| For sales and distribution Information, program advice and maintenance, contact: | | |
| TRL Limited Crowthorne House Nine Mile Ride Wokingham, Berks. RG40 3GA, UK |  | Tel: +44 (0)1344 770758 Fax: +44 (0)1344 770864 E-mail: softwarebureau@trl.co.uk Web: www.trlsoftware.co.uk |
| The user of this computer program for the solution of an engineering problem is in no way relieved of their responsibility for the correctness of the solution | | |

Run Analysis

| Parameter | Values |
|--------------|---|
| File Run | G:\..\Far Moor Lane Illshaw Close Staggered Crossroads\20000 BIC 2017 PM Peak.vpi |
| Date Run | 23 September 2009 |
| Time Run | 16:07:25 |
| Driving Side | Drive On The Left |

Arm Names and Flow Scaling Factors

| Arm | Arm Name | Flow Scaling Factor (%) |
|-------|---------------------|-------------------------|
| Arm A | Far Moor Lane North | 100 |
| Arm B | RBC Land | 100 |
| Arm C | Far Moor Lane South | 100 |
| Arm D | Illshaw Close | 100 |

Stream Labelling Convention

Stream A-B contains traffic going from A to B etc.

Run Information

| Parameter | Values |
|-------------|--------------------------|
| Run Title | 20000 BIC 2017 PM Peak |
| Location | Redditch |
| Date | 23 September 2009 |
| Enumerator | lbates [HP24852250691] |
| Job Number | 835 |
| Status | - |
| Client | Redditch Borough Council |
| Description | - |

Errors and Warnings

| Parameter | Values |
|-----------|-----------------------|
| Warning | No Errors Or Warnings |

Geometric Data**Geometric Parameters**

| Parameter | Minor Arm B | Minor Arm D |
|---|-------------|-------------|
| Major Road Carriageway Width (m) | 8.60 | 9.00 |
| Major Road Kerbed Central Reserve Width (m) | 0.00 | 0.00 |
| Major Road Right Turning Lane Width (m) | 5.00 | 3.50 |
| Minor Road Width 0m Back from Junction (m) | 10.00 | 10.00 |
| Minor Road Width 5m Back from Junction (m) | 10.00 | 4.75 |
| Minor Road Width 10m Back from Junction (m) | 6.50 | 2.50 |
| Minor Road Width 15m Back from Junction (m) | 4.50 | 2.50 |
| Minor Road Width 20m Back from Junction (m) | 3.50 | 2.50 |
| Minor Road Flare Length (veh) | 1 | 1 |
| Minor Road Visibility To Right (m) | 65 | 56 |
| Minor Road Visibility To Left (m) | 52 | 43 |
| Major Road Right Turn Visibility (m) | 200 | 200 |
| Major Road Right Turn Blocks Traffic | No | No |

Slope and Intercept Values

| Stream | Intercept for Stream B-C | Slope for A-B | Slope for A-C | Slope for A-D | Slope for B-A | Slope for B-D | Slope for C-A | Slope for C-B | Slope for C-D | Slope for D-B | Slope for D-C |
|--------|--------------------------|---------------|---------------|---------------|---------------|---------------|---------------|---------------|---------------|---------------|---------------|
| B-C | 611.605 | 0.078 | 0.198 | - | - | - | - | - | - | 0.078 | 0.198 |
| B-AD | 484.467 | 0.083 | 0.210 | - | - | - | 0.124 | 0.283 | 0.124 | 0.083 | 0.210 |
| D-A | 606.393 | 0.081 | - | - | - | - | 0.204 | - | - | 0.081 | 0.204 |
| D-BC | 484.467 | 0.120 | 0.120 | 0.273 | 0.191 | 0.076 | 0.191 | - | 0.076 | - | - |
| C-B | 899.987 | 0.309 | 0.309 | - | - | - | - | - | - | 0.309 | 0.309 |
| A-D | 899.987 | - | - | - | 0.265 | 0.265 | 0.265 | - | 0.265 | - | - |

Note: Streams may be combined in which case capacity will be adjusted
 These values do not allow for any site-specific corrections

Junction Diagram

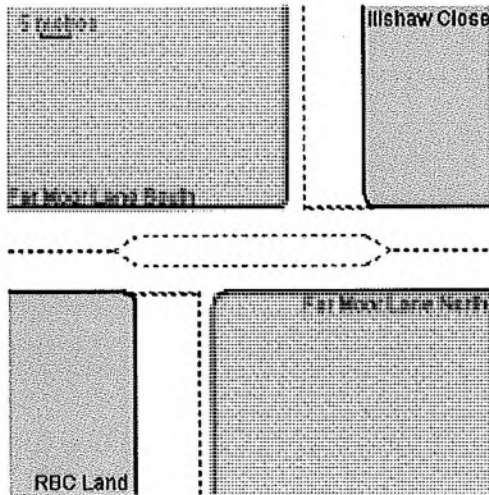

Demand Data

Modelling Periods

| Parameter | Period | Duration (min) | Segment Length (min) |
|------------------------|-------------|----------------|----------------------|
| First Modelling Period | 16:45-18:15 | 90 | 15 |

ODTAB Turning Counts

Demand Set: 20000 BIC 2017 AM Peak

Modelling Period: 16:45-18:15

| From/To | Arm A | Arm B | Arm C | Arm D |
|---------|-------|-------|-------|-------|
| Arm A | 0.0 | 25.0 | 224.0 | 15.0 |
| Arm B | 160.0 | 0.0 | 160.0 | 0.0 |
| Arm C | 119.0 | 25.0 | 0.0 | 15.0 |
| Arm D | 9.0 | 0.0 | 9.0 | 0.0 |

ODTAB Synthesised Flows

Demand Set: 20000 BIC 2017 AM Peak
Modelling Period: 16:45-18:15

| Arm | Rising Time | Rising Flow (veh/min) | Peak Time | Peak Flow (veh/min) | Falling Time | Falling Flow (veh/min) |
|-------|-------------|-----------------------|-----------|---------------------|--------------|------------------------|
| Arm A | 17:00 | 3.300 | 17:00 | 4.950 | 17:30 | 3.300 |
| Arm B | 17:00 | 4.000 | 17:00 | 6.000 | 17:30 | 4.000 |
| Arm C | 17:00 | 1.987 | 17:00 | 2.981 | 17:30 | 1.987 |
| Arm D | 17:00 | 0.225 | 17:00 | 0.337 | 17:30 | 0.225 |

Heavy Vehicles Percentages

Demand Set: 20000 BIC 2017 AM Peak
Modelling Period: 16:45-18:15

| From/To | Arm A | Arm B | Arm C | Arm D |
|---------|-------|-------|-------|-------|
| Arm A | - | 10.0 | 10.0 | 10.0 |
| Arm B | 10.0 | - | 10.0 | 10.0 |
| Arm C | 10.0 | 10.0 | - | 10.0 |
| Arm D | 10.0 | 10.0 | 10.0 | - |

Default proportions of heavy vehicles are used

Queue Diagrams

Demand Set: Sum of Demand Sets for Modelling Period: 16:45 - 18:15
Modelling Period: 16:45-18:15
View Extent: 40m

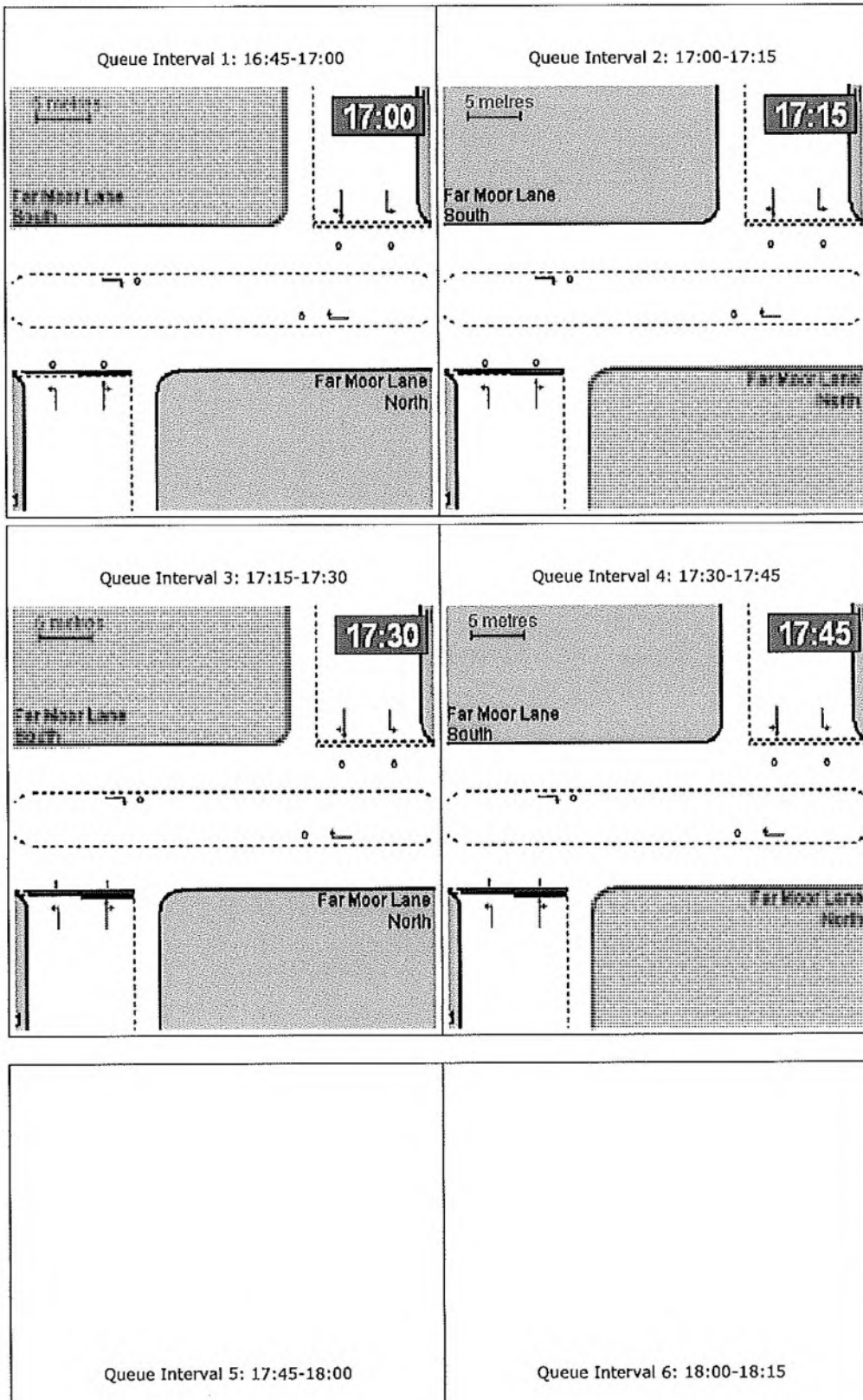

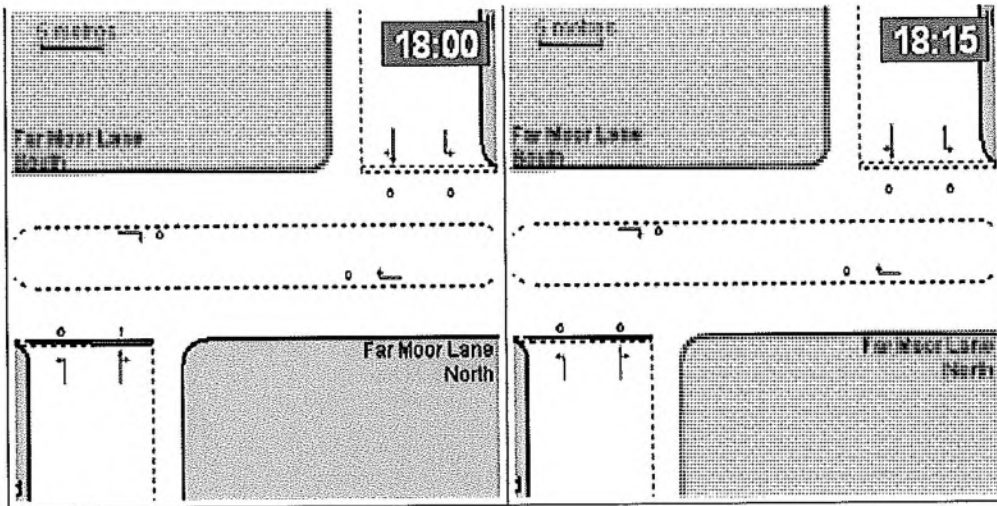

Capacity Graph

Demand Set: Sum of Demand Sets for Modelling Period: 16:45 - 18:15
Modelling Period: 16:45-18:15

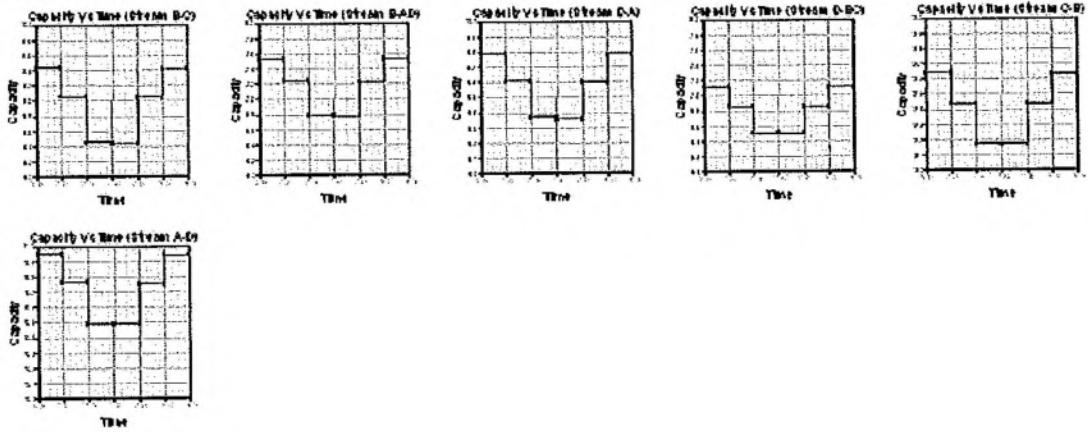

RFC Graph

Demand Set: Sum of Demand Sets for Modelling Period: 16:45 - 18:15
 Modelling Period: 16:45-18:15

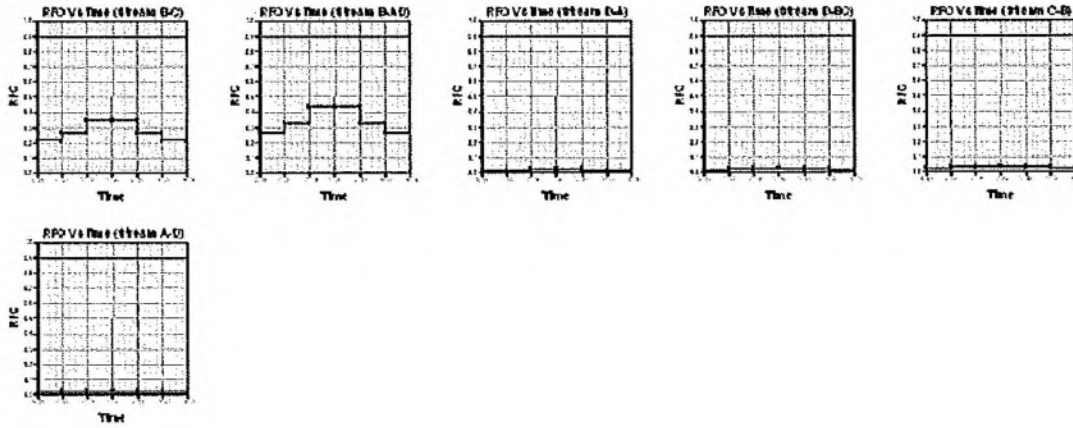

Start Queue Graph

Demand Set: Sum of Demand Sets for Modelling Period: 16:45 - 18:15
 Modelling Period: 16:45-18:15

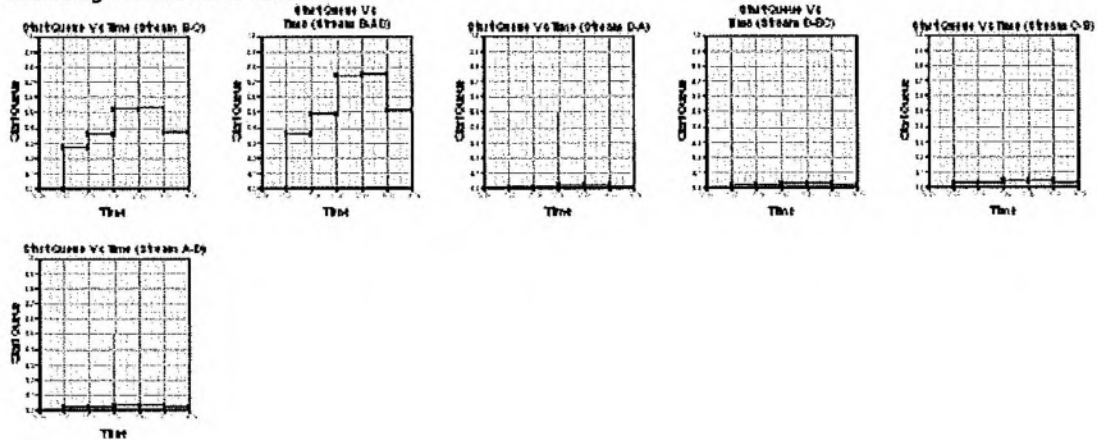

End Queue Graph

Demand Set: Sum of Demand Sets for Modelling Period: 16:45 - 18:15
 Modelling Period: 16:45-18:15

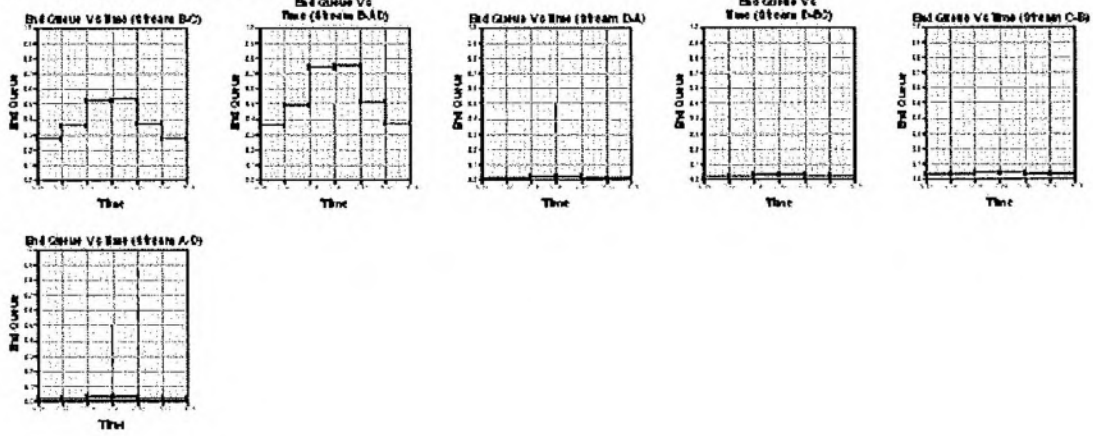

Delay Graph

Demand Set: Sum of Demand Sets for Modelling Period: 16:45 - 18:15
 Modelling Period: 16:45-18:15

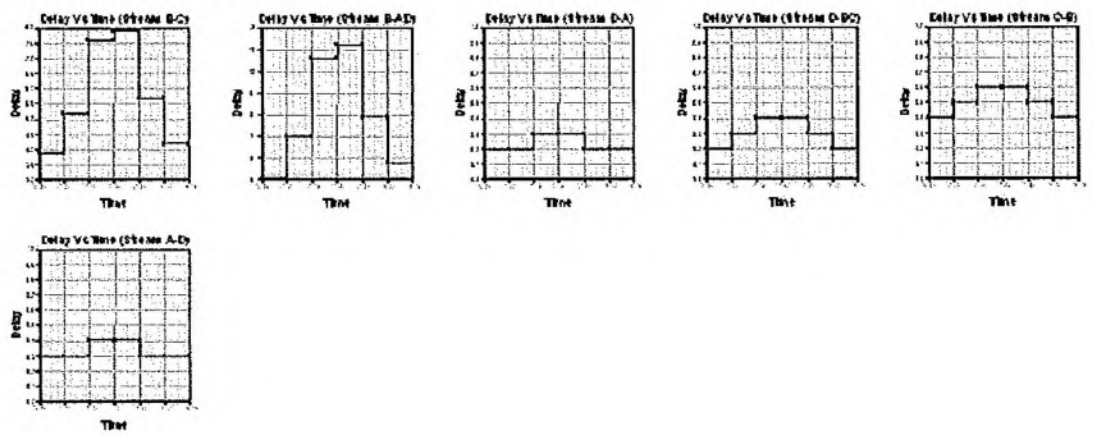

Queues & Delays

Demand Set: Sum of Demand Sets for Modelling Period: 16:45 - 18:15
 Modelling Period: 16:45-18:15

| Segment | Stream | Demand (veh/min) | Capacity (veh/min) | RFC | Ped. Flow (ped/min) | Start Queue (veh) | End Queue (veh) | Geometric Delay (veh.min/segment) | Delay (veh.min/segment) | Mean Arriving Vehicle Delay (min) |
|-------------|--------|------------------|--------------------|-------|---------------------|-------------------|-----------------|-----------------------------------|-------------------------|-----------------------------------|
| 16:45-17:00 | B-C | 2.01 | 9.44 | 0.213 | - | 0.00 | 0.27 | - | 3.9 | 0.13 |
| | B-AD | 2.01 | 7.52 | 0.267 | - | 0.00 | 0.36 | - | 5.1 | 0.18 |
| | D-A | 0.11 | 9.79 | 0.012 | - | 0.00 | 0.01 | - | 0.2 | 0.10 |
| | D-BC | 0.11 | 7.12 | 0.016 | - | 0.00 | 0.02 | - | 0.2 | 0.14 |
| | C-A | 1.49 | - | - | - | - | - | - | - | - |
| | C-B | 0.31 | 12.64 | 0.025 | - | 0.00 | 0.03 | - | 0.4 | 0.08 |
| | C-D | 0.19 | - | - | - | - | - | - | - | - |
| | A-B | 0.31 | - | - | - | - | - | - | - | - |
| | A-C | 2.81 | - | - | - | - | - | - | - | - |
| A-D | 0.19 | 10.95 | 0.017 | - | 0.00 | 0.02 | - | 0.3 | 0.09 | |

| Segment | Stream | Demand (veh/min) | Capacity (veh/min) | RFC | Ped. Flow (ped/min) | Start Queue (veh) | End Queue (veh) | Geometric Delay (veh.min/segment) | Delay (veh.min/segment) | Mean Arriving Vehicle Delay (min) |
|-------------|--------|------------------|--------------------|-------|---------------------|-------------------|-----------------|-----------------------------------|-------------------------|-----------------------------------|
| 17:00-17:15 | B-C | 2.40 | 9.05 | 0.265 | - | 0.27 | 0.36 | - | 5.2 | 0.15 |
| | B-AD | 2.40 | 7.24 | 0.331 | - | 0.36 | 0.49 | - | 7.0 | 0.21 |
| | D-A | 0.13 | 9.61 | 0.014 | - | 0.01 | 0.01 | - | 0.2 | 0.11 |
| | D-BC | 0.13 | 6.86 | 0.020 | - | 0.02 | 0.02 | - | 0.3 | 0.15 |
| | C-A | 1.78 | - | - | - | - | - | - | - | - |
| | C-B | 0.37 | 12.44 | 0.030 | - | 0.03 | 0.03 | - | 0.5 | 0.08 |
| | C-D | 0.22 | - | - | - | - | - | - | - | - |
| | A-B | 0.37 | - | - | - | - | - | - | - | - |
| | A-C | 3.36 | - | - | - | - | - | - | - | - |
| A-D | 0.22 | 10.76 | 0.021 | - | 0.02 | 0.02 | - | 0.3 | 0.09 | |

| Segment | Stream | Demand (veh/min) | Capacity (veh/min) | RFC | Ped. Flow (ped/min) | Start Queue (veh) | End Queue (veh) | Geometric Delay (veh.min/segment) | Delay (veh.min/segment) | Mean Arriving Vehicle Delay (min) |
|-------------|--------|------------------|--------------------|-------|---------------------|-------------------|-----------------|-----------------------------------|-------------------------|-----------------------------------|
| 17:15-17:30 | B-C | 2.94 | 8.45 | 0.348 | - | 0.36 | 0.52 | - | 7.6 | 0.18 |
| | B-AD | 2.94 | 6.78 | 0.433 | - | 0.49 | 0.74 | - | 10.6 | 0.26 |
| | D-A | 0.17 | 9.37 | 0.018 | - | 0.01 | 0.02 | - | 0.3 | 0.11 |
| | D-BC | 0.17 | 6.51 | 0.025 | - | 0.02 | 0.03 | - | 0.4 | 0.16 |
| | C-A | 2.18 | - | - | - | - | - | - | - | - |
| | C-B | 0.46 | 12.17 | 0.038 | - | 0.03 | 0.04 | - | 0.6 | 0.09 |
| | C-D | 0.28 | - | - | - | - | - | - | - | - |
| | A-B | 0.46 | - | - | - | - | - | - | - | - |
| | A-C | 4.11 | - | - | - | - | - | - | - | - |
| A-D | 0.28 | 10.49 | 0.026 | - | 0.02 | 0.03 | - | 0.4 | 0.10 | |

| Segment | Stream | Demand (veh/min) | Capacity (veh/min) | RFC | Ped. Flow (ped/min) | Start Queue (veh) | End Queue (veh) | Geometric Delay (veh.min/segment) | Delay (veh.min/segment) | Mean Arriving Vehicle Delay (min) |
|-------------|--------|------------------|--------------------|-------|---------------------|-------------------|-----------------|-----------------------------------|-------------------------|-----------------------------------|
| 17:30-17:45 | B-C | 2.94 | 8.43 | 0.348 | - | 0.52 | 0.53 | - | 7.9 | 0.18 |
| | B-AD | 2.94 | 6.77 | 0.433 | - | 0.74 | 0.75 | - | 11.2 | 0.26 |
| | D-A | 0.17 | 9.36 | 0.018 | - | 0.02 | 0.02 | - | 0.3 | 0.11 |
| | D-BC | 0.17 | 6.51 | 0.025 | - | 0.03 | 0.03 | - | 0.4 | 0.16 |
| | C-A | 2.18 | - | - | - | - | - | - | - | - |
| | C-B | 0.46 | 12.17 | 0.038 | - | 0.04 | 0.04 | - | 0.6 | 0.09 |

| | | | | | | | | | | |
|--|-----|------|-------|-------|---|------|------|---|-----|------|
| | C-D | 0.28 | - | - | - | - | - | - | - | - |
| | A-B | 0.46 | - | - | - | - | - | - | - | - |
| | A-C | 4.11 | - | - | - | - | - | - | - | - |
| | A-D | 0.28 | 10.49 | 0.026 | - | 0.03 | 0.03 | - | 0.4 | 0.10 |

| Segment | Stream | Demand (veh/min) | Capacity (veh/min) | RFC | Ped. Flow (ped/min) | Start Queue (veh) | End Queue (veh) | Geometric Delay (veh.min/segment) | Delay (veh.min/segment) | Mean Arriving Vehicle Delay (min) |
|-------------|--------|------------------|--------------------|-------|---------------------|-------------------|-----------------|-----------------------------------|-------------------------|-----------------------------------|
| 17:45-18:00 | B-C | 2.40 | 9.04 | 0.265 | - | 0.53 | 0.37 | - | 5.7 | 0.15 |
| | B-AD | 2.40 | 7.23 | 0.331 | - | 0.75 | 0.51 | - | 7.9 | 0.21 |
| | D-A | 0.13 | 9.60 | 0.014 | - | 0.02 | 0.01 | - | 0.2 | 0.11 |
| | D-BC | 0.13 | 6.85 | 0.020 | - | 0.03 | 0.02 | - | 0.3 | 0.15 |
| | C-A | 1.78 | - | - | - | - | - | - | - | - |
| | C-B | 0.37 | 12.44 | 0.030 | - | 0.04 | 0.03 | - | 0.5 | 0.08 |
| | C-D | 0.22 | - | - | - | - | - | - | - | - |
| | A-B | 0.37 | - | - | - | - | - | - | - | - |
| | A-C | 3.36 | - | - | - | - | - | - | - | - |
| A-D | 0.22 | 10.75 | 0.021 | - | 0.03 | 0.02 | - | 0.3 | 0.10 | |

| Segment | Stream | Demand (veh/min) | Capacity (veh/min) | RFC | Ped. Flow (ped/min) | Start Queue (veh) | End Queue (veh) | Geometric Delay (veh.min/segment) | Delay (veh.min/segment) | Mean Arriving Vehicle Delay (min) |
|-------------|--------|------------------|--------------------|-------|---------------------|-------------------|-----------------|-----------------------------------|-------------------------|-----------------------------------|
| 18:00-18:15 | B-C | 2.01 | 9.42 | 0.213 | - | 0.37 | 0.27 | - | 4.2 | 0.14 |
| | B-AD | 2.01 | 7.52 | 0.267 | - | 0.51 | 0.37 | - | 5.8 | 0.18 |
| | D-A | 0.11 | 9.78 | 0.012 | - | 0.01 | 0.01 | - | 0.2 | 0.10 |
| | D-BC | 0.11 | 7.11 | 0.016 | - | 0.02 | 0.02 | - | 0.2 | 0.14 |
| | C-A | 1.49 | - | - | - | - | - | - | - | - |
| | C-B | 0.31 | 12.63 | 0.025 | - | 0.03 | 0.03 | - | 0.4 | 0.08 |
| | C-D | 0.19 | - | - | - | - | - | - | - | - |
| | A-B | 0.31 | - | - | - | - | - | - | - | - |
| | A-C | 2.81 | - | - | - | - | - | - | - | - |
| | A-D | 0.19 | 10.94 | 0.017 | - | 0.02 | 0.02 | - | 0.3 | 0.09 |

Entry capacities marked with an '(X)' are dominated by a pedestrian crossing in that time segment.
 In time segments marked with a '(B)', traffic leaving the junction may block back from a crossing so impairing normal operation of the junction.
 Delays marked with '###' could not be calculated.

Overall Queues & Delays

Queueing Delay Information Over Whole Period

Demand Set: Sum of Demand Sets for Modelling Period: 16:45 - 18:15

Modelling Period: 16:45-18:15

| Stream | Total Demand (veh) | Total Demand (veh/h) | Queueing Delay (min) | Queueing Delay (min/veh) | Inclusive Delay (min) | Inclusive Delay (min/veh) |
|------------|--------------------|----------------------|----------------------|--------------------------|-----------------------|---------------------------|
| B-C | 220.2 | 146.8 | 34.4 | 0.2 | 34.4 | 0.2 |
| B-AD | 220.2 | 146.8 | 47.6 | 0.2 | 47.6 | 0.2 |
| D-A | 12.4 | 8.3 | 1.3 | 0.1 | 1.3 | 0.1 |
| D-BC | 12.4 | 8.3 | 1.8 | 0.1 | 1.8 | 0.1 |
| C-A | 163.8 | 109.2 | - | - | - | - |
| C-B | 34.4 | 22.9 | 2.9 | 0.1 | 2.9 | 0.1 |
| C-D | 20.6 | 13.8 | - | - | - | - |
| A-B | 34.4 | 22.9 | - | - | - | - |
| A-C | 308.3 | 205.5 | - | - | - | - |
| A-D | 20.6 | 13.8 | 2.0 | 0.1 | 2.0 | 0.1 |
| All | 1047.5 | 698.3 | 90.0 | 0.1 | 90.0 | 0.1 |

Delay is that occurring only within the time period.

Inclusive delay includes delay suffered by vehicles which are still queuing after the end of the time period.

These will only be significantly different if there is a large queue remaining at the end of the time period.

PICADY 5 Run Successful

Full Input Data And Results

User and Project Details

| | |
|--------------------|---|
| Project: | Transport Assessment |
| Title: | Redditch Borough Council |
| Location: | A435 Birmingham Road |
| File name: | A435 Birmingham Road.lsgx |
| Author: | Adam Gibbs |
| Company: | Morgan Tucker |
| Address: | Aura Commerce and Technology Centre, Manners Road, Newark, Nottinghamshire, NG24 1BS |
| Controller: | Generic |
| SCN: | |
| Notes: | |

Junction Layout Diagram

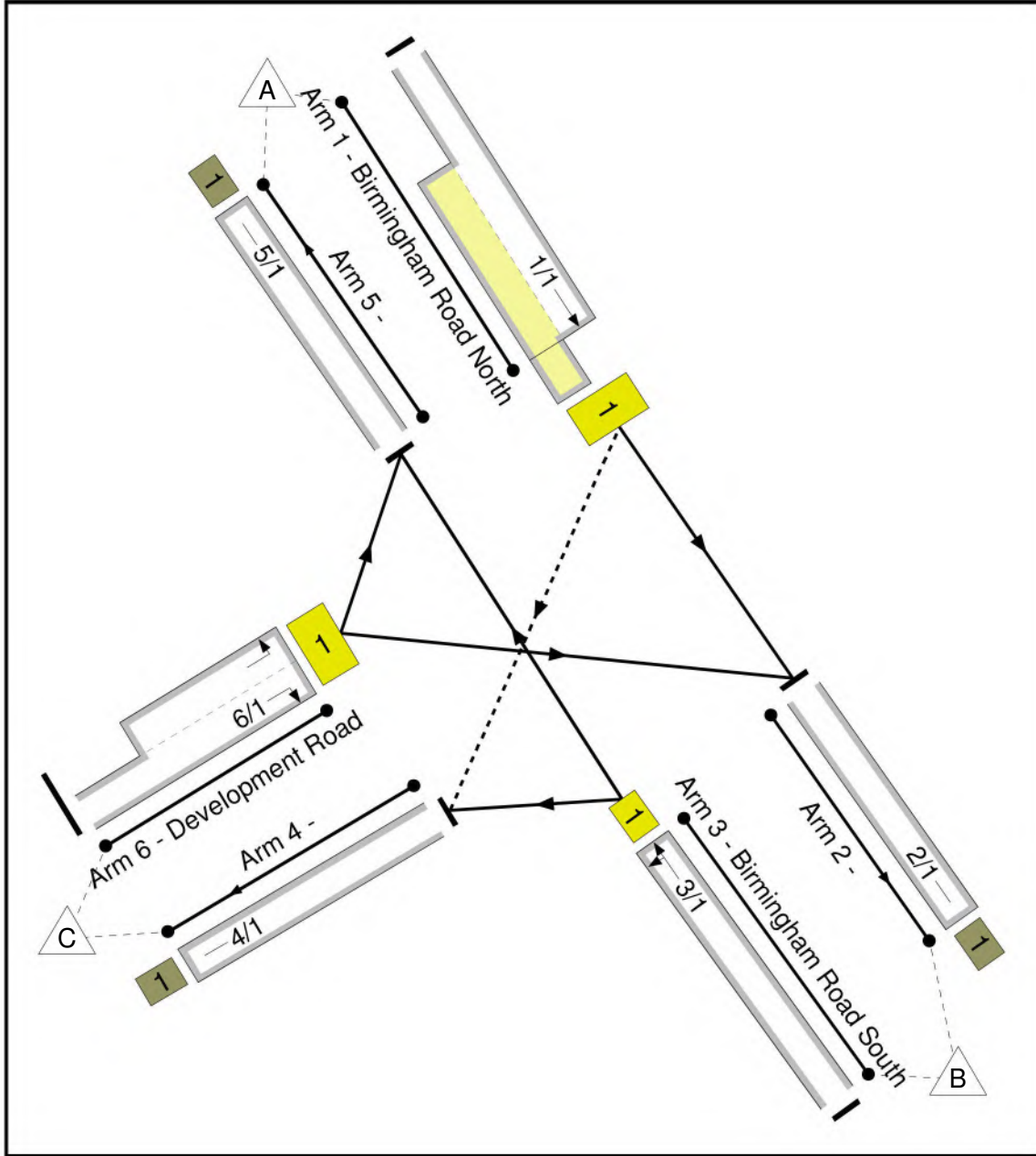

Phase Diagram

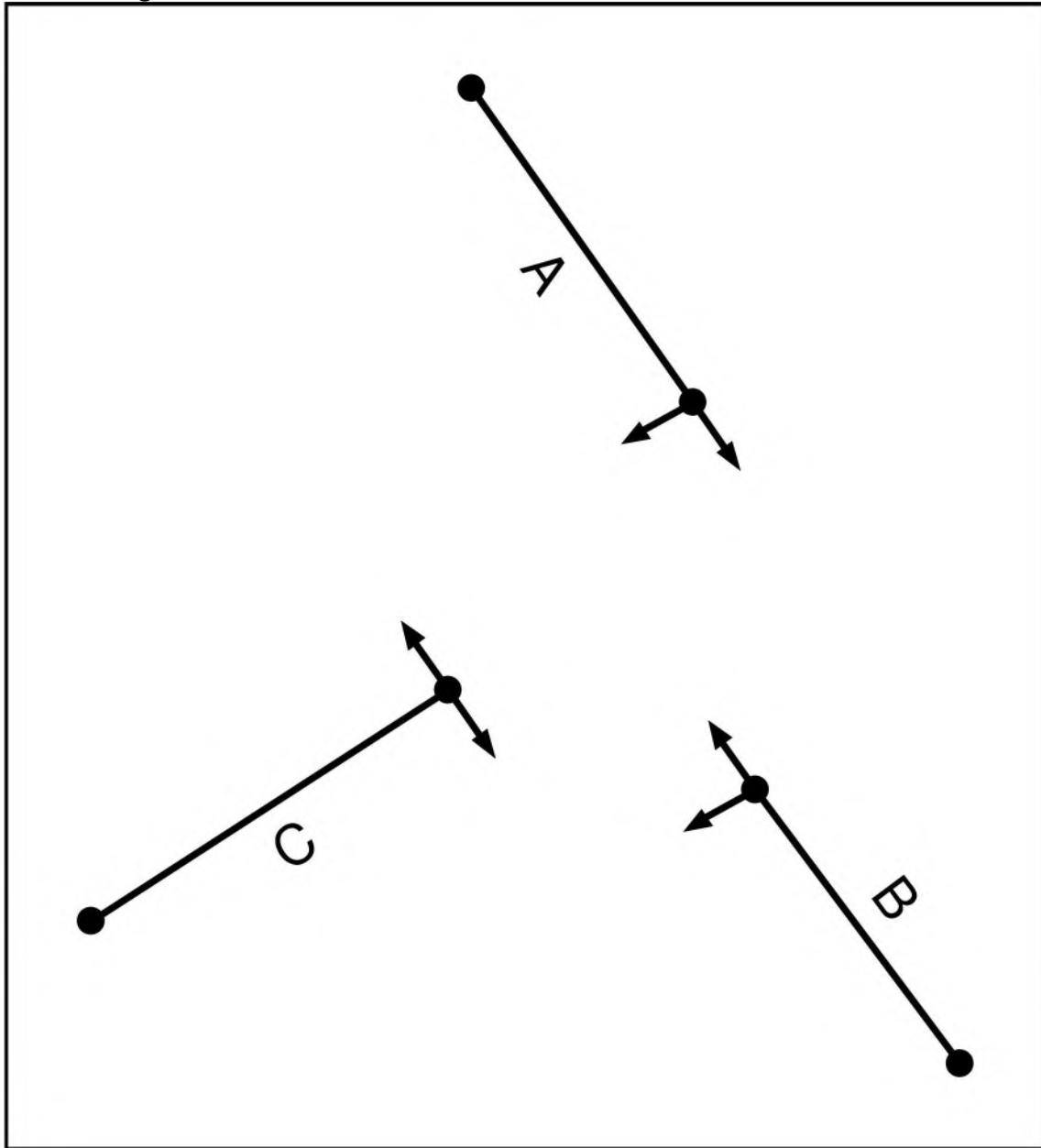

Phase Input Data

| Phase Name | Phase type | Assoc Phase | Street Min | Cont Min |
|------------|------------|-------------|------------|----------|
| A | Traffic | | 7 | 6 |
| B | Traffic | | 7 | 7 |
| C | Traffic | | 7 | 7 |

Phase Intergreens Matrix

| | | | | |
|-------------------|---|----------------|---|---|
| | | Starting Phase | | |
| | | A | B | C |
| Terminating Phase | A | - | 5 | |
| | B | 5 | - | 6 |
| | C | 5 | 5 | - |

Phases in Stage

| Stage No. | Phases in Stage |
|-----------|-----------------|
| 1 | A B |
| 2 | C |

Stages Diagram

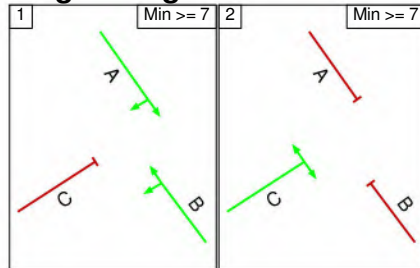

Phase Delays

| Term. Stage | Start Stage | Phase | Type | Value | Cont value |
|-------------|-------------|-------|--------|-------|------------|
| 1 | 2 | A | Losing | 1 | 1 |

Prohibited Stage Changes

| | | | |
|------------|---|----------|---|
| | | To Stage | |
| | | 1 | 2 |
| From Stage | 1 | - | 6 |
| | 2 | 5 | - |

Link Input Data

| Arm/ Link | Link Name | Link Type | Num Lanes | Phases | Start Disp. | End Disp. |
|----------------------|--------------------------------------|----------------------|----------------------|---------------|------------------------|----------------------|
| 1/1 | Birmingham Road North Ahead Right | O | 1 | A | 2 | 3 |
| 2/1 | | U | 1 | | 2 | 3 |
| 3/1 | Birmingham Road South Left Ahead | U | 1 | B | 2 | 3 |
| 4/1 | | U | 1 | | 2 | 3 |
| 5/1 | | U | 1 | | 2 | 3 |
| 6/1 | Development Road Right Left | U | 2 | C | 2 | 3 |

Full Input Data And Results

Give-Way Link Input Data

| Arm/ Link | Link Name | Movement | Max Flow when Giving Way (PCU/Hr) | Opposing Link | Opp. Link Coeff. | Opp. Mvmnts. | Right Turn Storage (PCU) | Non- Blocking Storage (PCU) | RTF | Right Turn Move up time (s) | Max Turns in Intergreen (PCU) |
|--------------|---|------------|---|------------------|------------------------|-----------------|--------------------------------|--------------------------------------|------|--------------------------------------|-------------------------------------|
| 1/1 | Birmingham Road North Ahead Right | 1/1 to 4/1 | 1440 | 3/1 | 1.09 | 3/1 | 2.00 | 10.00 | 0.50 | 2 | 2.00 |

Lane Input Data

| Arm/ Lane | Link Num | Physical Length (PCU) | Expected Usage (PCU) | Sat Flow Type | User Saturation Flow (PCU/Hr) | Lane Width (m) | Gradient | Nearside Lane | Allowed Turns | Turni Radii (m) |
|---|---|-----------------------------|----------------------------|---------------------|--|----------------------|----------|------------------|------------------|-----------------------|
| 1/1 (Birmingham Road North Lane 1) | Link 1 (Birmingham Road North Ahead Right) | Inf | Inf | User | 1900 | 3.25 | 0.00 | Y | Arm 2 Ahead | Inf |
| 2/1 | Link 1 | Inf | Inf | Inf (Exit) | 1800 | 3.25 | 0.00 | Y | | |
| 3/1 (Birmingham Road South Lane 1) | Link 1 (Birmingham Road South Left Ahead) | Inf | Inf | User | 1800 | 3.25 | 0.00 | Y | Arm 4 Left | Inf |
| | | | | | | | | | Arm 5 Ahead | Inf |
| 4/1 | Link 1 | Inf | Inf | Inf (Exit) | 1800 | 3.25 | 0.00 | Y | | |
| 5/1 | Link 1 | Inf | Inf | Inf (Exit) | 1800 | 3.25 | 0.00 | Y | | |
| 6/1 (Development Road Lane 1) | Link 1 (Development Road Right Left) | 5.0 | 7.0 | User | 1800 | 3.25 | 0.00 | Y | Arm 5 Left | Inf |
| 6/2 (Development Road Lane 2) | Link 1 (Development Road Right Left) | Inf | Inf | User | 1800 | 3.25 | 0.00 | Y | Arm 2 Right | Inf |

Traffic Flow Groups

| Flow Group | Start Time | End Time | Duration | Formula |
|--------------------|------------|----------|----------|---------|
| 1: 'Am Peak 2017 ' | 08:00 | 09:00 | 01:00 | |
| 2: 'Pm Peak 2017' | 17:00 | 18:00 | 01:00 | |

Flow Group 1: 'Am Peak 2017 '

Traffic Flow Matrix

Desired Flow :

| | Destination | | | | |
|--------|-------------|------|------|------|------|
| | A | B | C | Tot. | |
| Origin | A | 0 | 1109 | 205 | 1314 |
| | B | 1095 | 0 | 205 | 1300 |
| | C | 20 | 20 | 0 | 40 |
| | Tot. | 1115 | 1129 | 410 | 2654 |

Link Traffic Flows

| Arm/Link | Flow Group 1: Am Peak 2017 |
|----------|----------------------------|
| 1/1 | 1314 |
| 2/1 | 1129 |
| 3/1 | 1300 |
| 4/1 | 410 |
| 5/1 | 1115 |
| 6/1 | 40 |

Lane Saturation Flows

| Arm/Lane | Lane Width (m) | Gradient | Nearside Lane | Allowed Turns | Turning Radius (m) | Turning Prop. | Sat flow (PCU/Hr) |
|---------------------------------------|----------------|----------|---------------|---------------|--------------------|---------------|---|
| 1/1 (Birmingham Road North Lane 1) | | | | | | | This lane uses a directly entered Saturation Flow 1900 |
| 2/1 | | | | | | | Infinite Saturation Flow (on Exit Link) Inf |
| 3/1 (Birmingham Road South Lane 1) | | | | | | | This lane uses a directly entered Saturation Flow 1800 |
| 4/1 | | | | | | | Infinite Saturation Flow (on Exit Link) Inf |
| 5/1 | | | | | | | Infinite Saturation Flow (on Exit Link) Inf |
| 6/1 (Development Road Lane 1) | | | | | | | This lane uses a directly entered Saturation Flow 1800 |
| 6/2 (Development Road Lane 2) | | | | | | | This lane uses a directly entered Saturation Flow 1800 |

Flow Group 2: 'Pm Peak 2017'**Traffic Flow Matrix****Desired Flow :**

| | | Destination | | | |
|--------|------|-------------|------|----|------|
| | | A | B | C | Tot. |
| Origin | A | 0 | 1217 | 26 | 1243 |
| | B | 1110 | 0 | 24 | 1134 |
| | C | 166 | 154 | 0 | 320 |
| | Tot. | 1276 | 1371 | 50 | 2697 |

Link Traffic Flows

| Arm/Link | Flow Group 2: Pm Peak 2017 |
|----------|----------------------------|
| 1/1 | 1243 |
| 2/1 | 1371 |
| 3/1 | 1134 |
| 4/1 | 50 |
| 5/1 | 1276 |
| 6/1 | 320 |

Lane Saturation Flows

| Arm/Lane | Lane Width (m) | Gradient | Nearside Lane | Allowed Turns | Turning Radius (m) | Turning Prop. | Sat flow (PCU/Hr) |
|---------------------------------------|----------------|----------|---------------|---------------|--------------------|---------------|---|
| 1/1 (Birmingham Road North Lane 1) | | | | | | | This lane uses a directly entered Saturation Flow 1900 |
| 2/1 | | | | | | | Infinite Saturation Flow (on Exit Link) Inf |
| 3/1 (Birmingham Road South Lane 1) | | | | | | | This lane uses a directly entered Saturation Flow 1800 |
| 4/1 | | | | | | | Infinite Saturation Flow (on Exit Link) Inf |
| 5/1 | | | | | | | Infinite Saturation Flow (on Exit Link) Inf |
| 6/1 (Development Road Lane 1) | | | | | | | This lane uses a directly entered Saturation Flow 1800 |
| 6/2 (Development Road Lane 2) | | | | | | | This lane uses a directly entered Saturation Flow 1800 |

Scenario 1: 'Scenario 1'

Staging Plan 1: 'Staging Plan No. 1'

Flow Group 1: 'Am Peak 2017'

Staging Plan Diagram

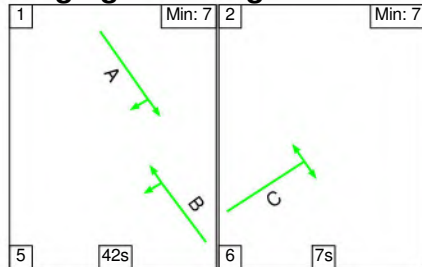

Stage Timings

| Stage | 1 | 2 |
|--------------|----|----|
| Duration | 42 | 7 |
| Change Point | 0 | 47 |

Signal Timings Diagram

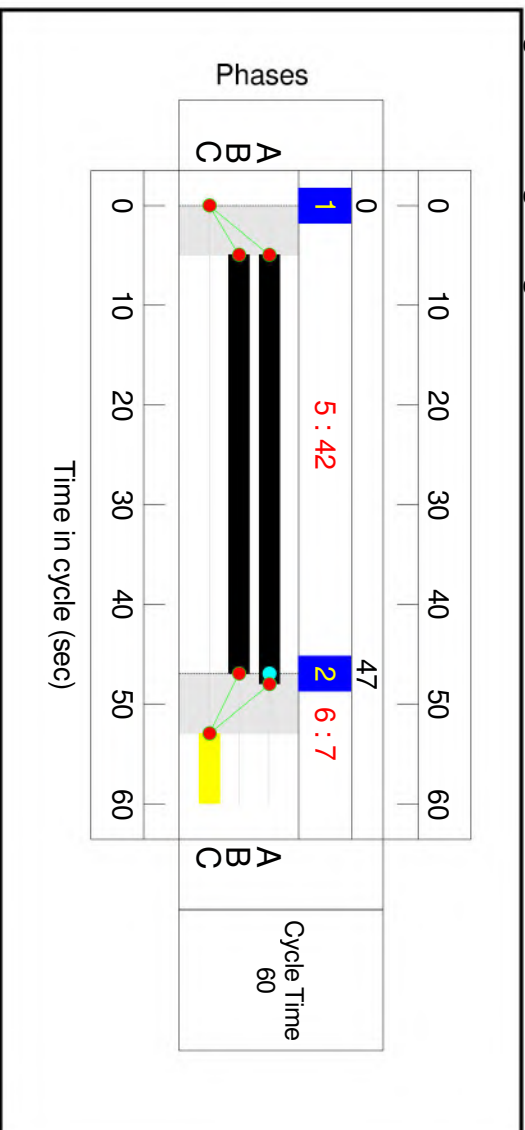

Full Input Data And Results

Junction Layout Diagram

Full Input Data And Results

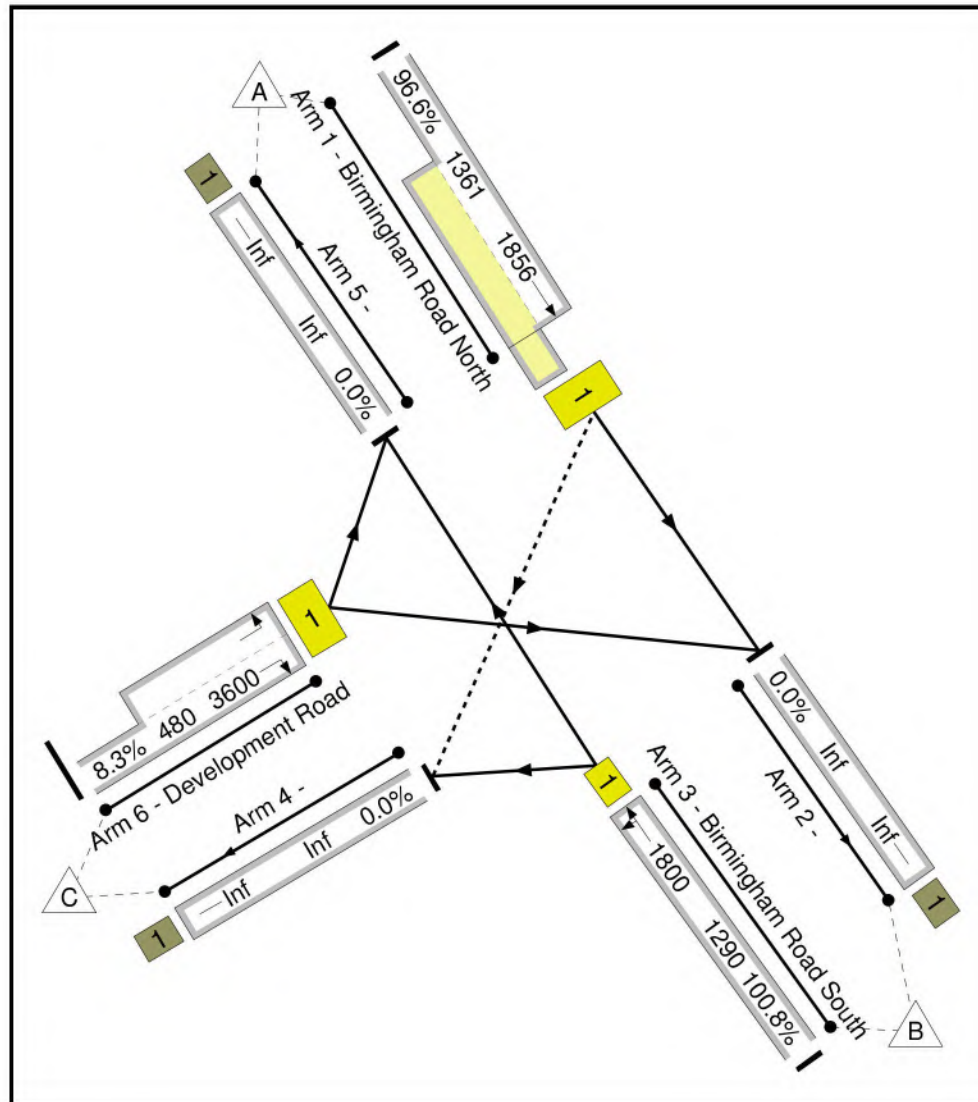

Full Input Data And Results

Link Results

| Link Num | Link Desc | Link Type | Stage Stream | Position In Filtered Route | Full Phase | Arrow Phase | Num Greens | Total Green (s) | Arrow Green (s) | Demand Flow (pcu) | Max Sat Flow (pcu/Hr) | Ave Sat Flow (pcu/Hr) | Capacity (pcu) | Deg Sat (%) |
|------------------------------|-----------------------------------|---------------|-----------------------|--|-----------------------------|-----------------------|------------------------------|------------------------------------|---------------------|---------------------------|----------------------------------|----------------------------|----------------------|-------------|
| 1/1 | Birmingham Road North Ahead Right | O | N/A | N/A | A | | 1 | 43 | - | 1314 | 1900 | 1856 | 1361 | 96.6 |
| 2/1 | | U | N/A | N/A | - | | - | - | - | 1129 | Inf | Inf | Inf | 0.0 |
| 3/1 | Birmingham Road South Left Ahead | U | N/A | N/A | B | | 1 | 42 | - | 1300 | 1800 | 1800 | 1290 | 100.8 |
| 4/1 | | U | N/A | N/A | - | | - | - | - | 410 | Inf | Inf | Inf | 0.0 |
| 5/1 | | U | N/A | N/A | - | | - | - | - | 1115 | Inf | Inf | Inf | 0.0 |
| 6/1 | Development Road Right Left | U | N/A | N/A | C | | 1 | 7 | - | 40 | 3600 | 3600 | 480 | 8.3 |
| Link Num | Entering (pcu) | Leaving (pcu) | Turners In Gaps (pcu) | Turners When Unopposed (pcu) | Turners In Intergreen (pcu) | Uniform Delay (pcuHr) | Rand + Oversat Delay (pcuHr) | Storage Area Uniform Delay (pcuHr) | Total Delay (pcuHr) | Av. Delay Per Veh (s/pcu) | Max. Back of Uniform Queue (pcu) | Rand + Oversat Queue (pcu) | Mean Max Queue (pcu) | |
| 1/1 | 1314 | 1229 | 0 | 0 | 120 | 4.0 | 9.9 | 1.4 | 15.3 | 42.0 | 23.6 | 9.9 | 33.5 | |
| 2/1 | 1129 | 1129 | - | - | - | 0.0 | 0.0 | - | 0.0 | 0.0 | 0.0 | 0.0 | 0.0 | |
| 3/1 | 1300 | 1290 | - | - | - | 3.3 | 20.7 | - | 24.0 | 66.5 | 21.8 | 20.7 | 42.5 | |
| 4/1 | 323 | 323 | - | - | - | 0.0 | 0.0 | - | 0.0 | 0.0 | 0.0 | 0.0 | 0.0 | |
| 5/1 | 1107 | 1107 | - | - | - | 0.0 | 0.0 | - | 0.0 | 0.0 | 0.0 | 0.0 | 0.0 | |
| 6/1 | 40 | 40 | - | - | - | 0.3 | 0.0 | - | 0.3 | 27.1 | 0.6 | 0.0 | 0.6 | |
| PRC for Signalled Links (%): | | | -12.0 | Total Delay for Signalled Links (pcuHr): | | | 39.66 | | | | | | | |
| PRC Over All Links (%): | | | -12.0 | Total Delay Over All Links(pcuHr): | | | 39.66 | Cycle Time (s): | | 60 | | | | |

Scenario 2: 'New Scenario'

Staging Plan 1: 'Staging Plan No. 1'

Flow Group 2: 'Pm Peak 2017'

Staging Plan Diagram

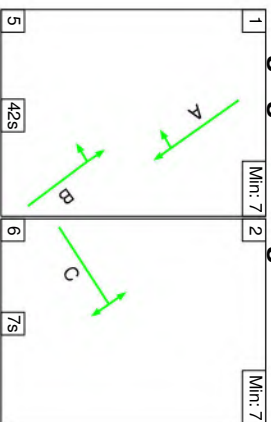

Stage Timings

| Stage | 1 | 2 |
|--------------|----|----|
| Duration | 42 | 7 |
| Change Point | 0 | 47 |

Signal Timings Diagram

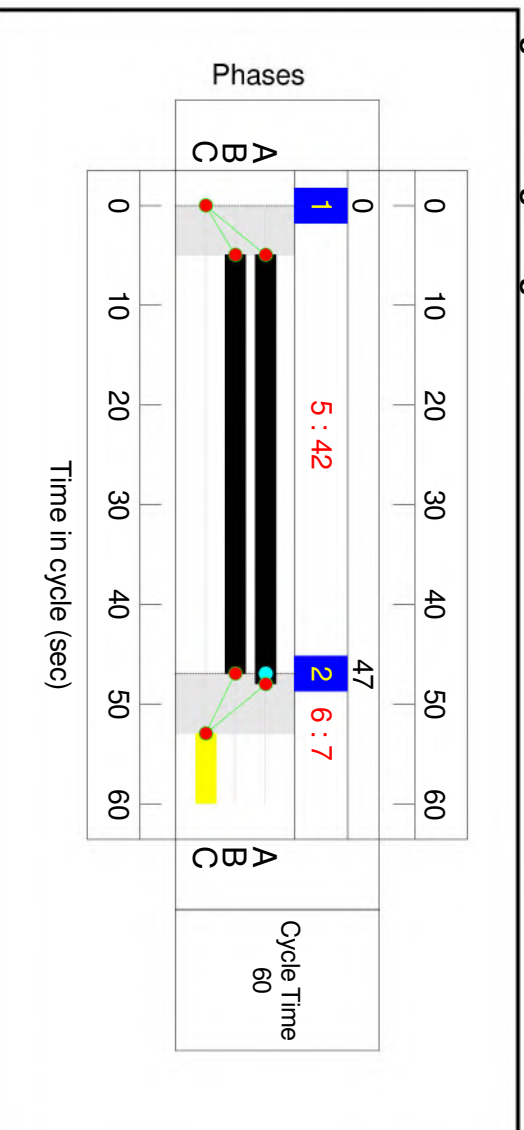

Full Input Data And Results

Junction Layout Diagram

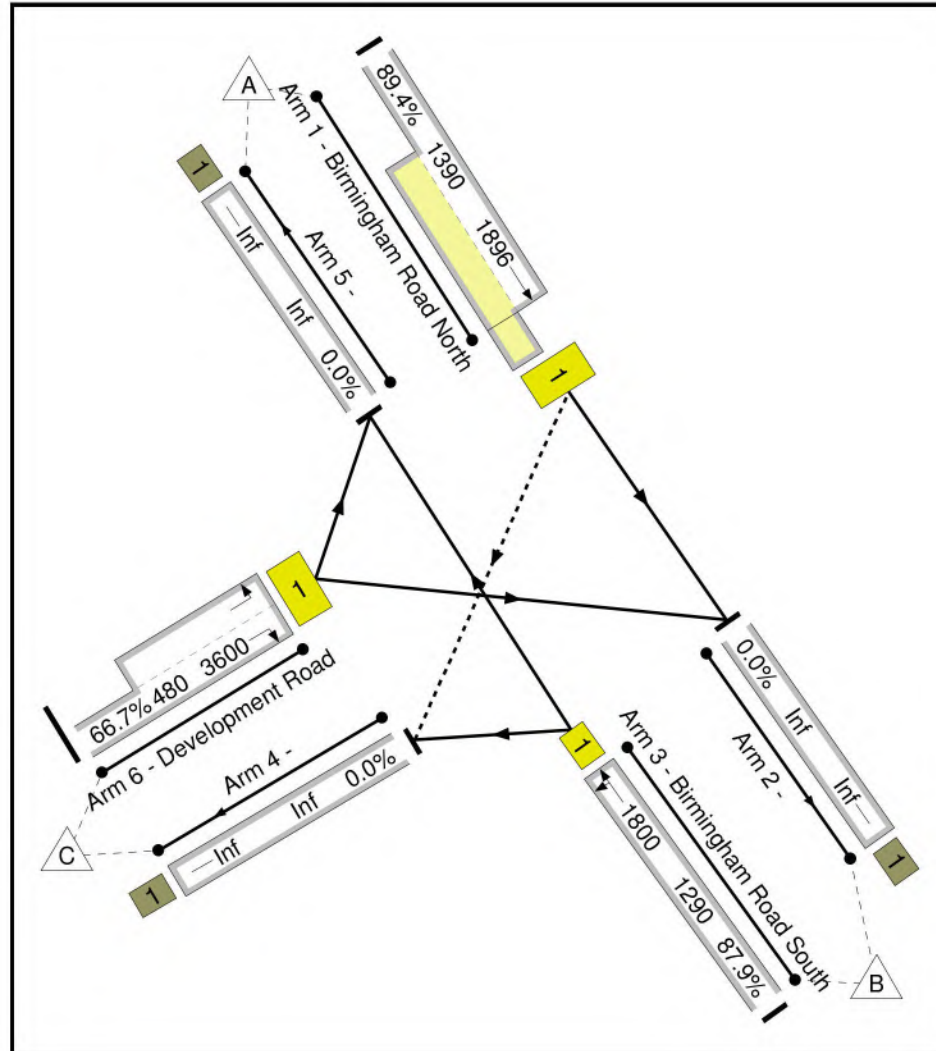

Full Input Data And Results

Link Results

| Link Num | Link Desc | Link Type | Stage Stream | Position In Filtered Route | Full Phase | Arrow Phase | Num Greens | Total Green (s) | Arrow Green (s) | Demand Flow (pcu) | Max Sat Flow (pcu/Hr) | Ave Sat Flow (pcu/Hr) | Capacity (pcu) | Deg Sat (%) | |
|------------------------------|-----------------------------------|---------------|-----------------------|------------------------------|--|-----------------------|------------------------------|------------------------------------|---------------------|---------------------------|----------------------------------|----------------------------|----------------------|-------------|--|
| 1/1 | Birmingham Road North Ahead Right | O | N/A | N/A | A | | 1 | 43 | - | 1243 | 1900 | 1896 | 1390 | 89.4 | |
| 2/1 | | U | N/A | N/A | - | | - | - | - | 1371 | Inf | Inf | Inf | 0.0 | |
| 3/1 | Birmingham Road South Left Ahead | U | N/A | N/A | B | | 1 | 42 | - | 1134 | 1800 | 1800 | 1290 | 87.9 | |
| 4/1 | | U | N/A | N/A | - | | - | - | - | 50 | Inf | Inf | Inf | 0.0 | |
| 5/1 | | U | N/A | N/A | - | | - | - | - | 1276 | Inf | Inf | Inf | 0.0 | |
| 6/1 | Development Road Right Left | U | N/A | N/A | C | | 1 | 7 | - | 320 | 3600 | 3600 | 480 | 66.7 | |
| Link Num | Entering (pcu) | Leaving (pcu) | Turners In Gaps (pcu) | Turners When Unopposed (pcu) | Turners In Intergreen (pcu) | Uniform Delay (pcuHr) | Rand + Oversat Delay (pcuHr) | Storage Area Uniform Delay (pcuHr) | Total Delay (pcuHr) | Av. Delay Per Veh (s/pcu) | Max. Back of Uniform Queue (pcu) | Rand + Oversat Queue (pcu) | Mean Max Queue (pcu) | | |
| 1/1 | 1243 | 1243 | 26 | 0 | 0 | 2.1 | 4.0 | 0.1 | 6.2 | 18.0 | 15.9 | 4.0 | 19.9 | | |
| 2/1 | 1371 | 1371 | - | - | - | 0.0 | 0.0 | - | 0.0 | 0.0 | 0.0 | 0.0 | 0.0 | | |
| 3/1 | 1134 | 1134 | - | - | - | 2.1 | 3.5 | - | 5.5 | 17.6 | 14.2 | 3.5 | 17.7 | | |
| 4/1 | 50 | 50 | - | - | - | 0.0 | 0.0 | - | 0.0 | 0.0 | 0.0 | 0.0 | 0.0 | | |
| 5/1 | 1276 | 1276 | - | - | - | 0.0 | 0.0 | - | 0.0 | 0.0 | 0.0 | 0.0 | 0.0 | | |
| 6/1 | 320 | 320 | - | - | - | 2.2 | 1.0 | - | 3.2 | 35.9 | 5.1 | 1.0 | 6.1 | | |
| PRC for Signalled Links (%): | | | | 0.7 | Total Delay for Signalled Links (pcuHr): | | | | 14.93 | | | | | | |
| PRC Over All Links (%): | | | | 0.7 | Total Delay Over All Links(pcuHr): | | | | 14.93 | Cycle Time (s): 60 | | | | | |

Full Input Data And Results

User and Project Details

| | |
|--------------------|--|
| Project: | Transport Assessment |
| Title: | Redditch Borough Council |
| Location: | Coventry Highway |
| File name: | Coventry Highway. |
| Author: | Adam Gibbs |
| Company: | Morgan Tucker |
| Address: | Aura Commerce and Technology Centre, Manners Road, Newark, Nottinghamshire, NG24 1BS |
| Controller: | Generic |
| SCN: | |
| Notes: | |

Junction Layout Diagram

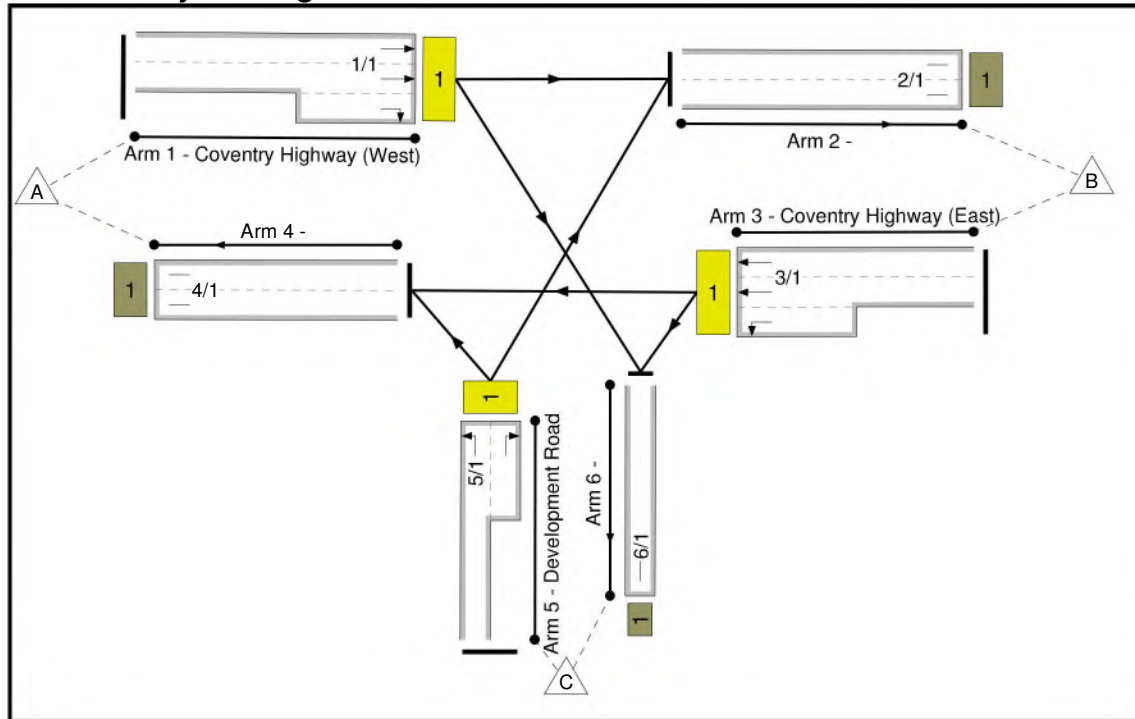

Phase Diagram

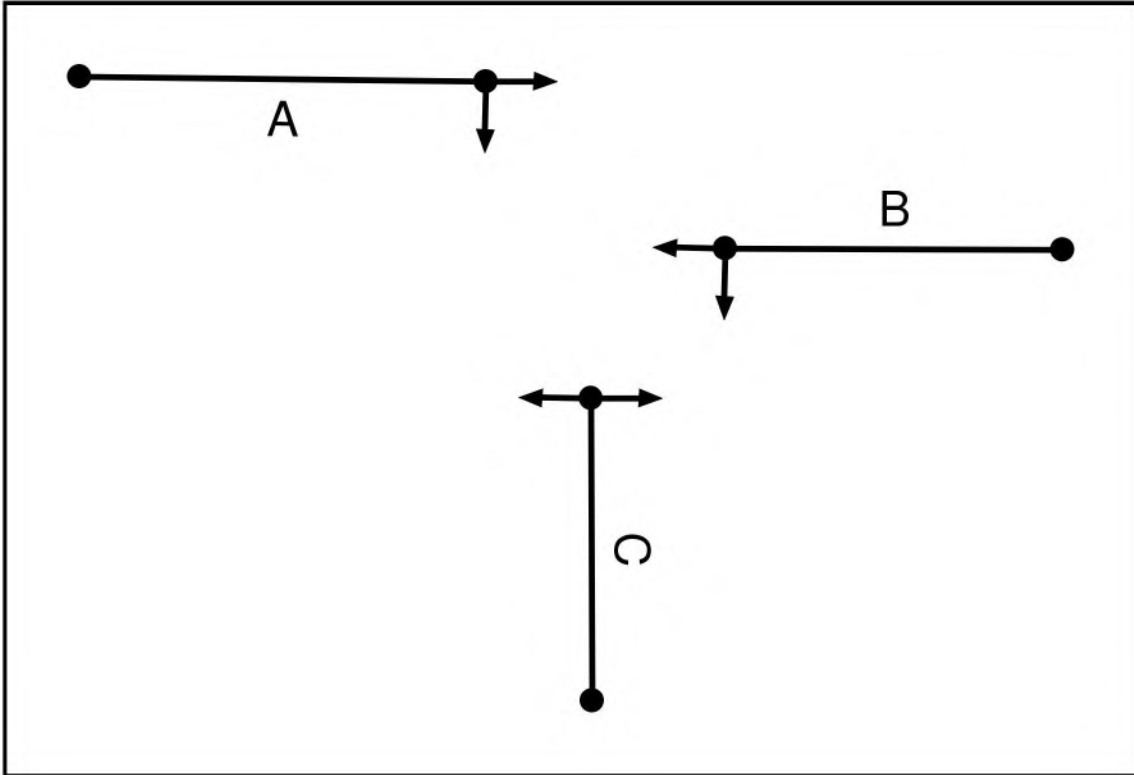

Phase Input Data

| Phase Name | Phase type | Assoc Phase | Street Min | Cont Min |
|------------|------------|-------------|------------|----------|
| A | Traffic | | 7 | 7 |
| B | Traffic | | 7 | 7 |
| C | Traffic | | 7 | 7 |

Phase Intergreens Matrix

| | | Starting Phase | | |
|-------------------|---|----------------|---|---|
| | | A | B | C |
| Terminating Phase | A | | 5 | 5 |
| | B | 5 | | 5 |
| | C | 6 | 5 | |

Phases in Stage

| Stage No. | Phases in Stage |
|-----------|-----------------|
| 1 | A |
| 2 | B |
| 3 | C |

Stages Diagram

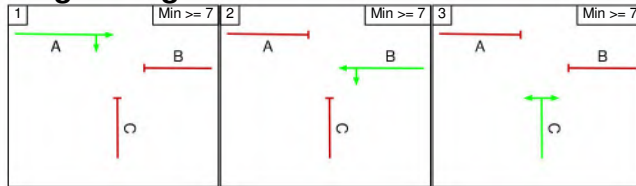

Phase Delays

There are no phase delays defined in this stage stream

Prohibited Stage Changes

| | | To Stage | | |
|------------|---|----------|---|---|
| | | 1 | 2 | 3 |
| From Stage | 1 | | 5 | 5 |
| | 2 | 5 | | 5 |
| | 3 | 6 | 5 | |

Link Input Data

| Arm/Link | Link Name | Link Type | Num Lanes | Phases | Start Disp. | End Disp. |
|----------|-------------------------------------|-----------|-----------|--------|-------------|-----------|
| 1/1 | Coventry Highway (West) Ahead Right | U | 3 | A | 2 | 3 |
| 2/1 | | U | 2 | | 2 | 3 |
| 3/1 | Coventry Highway (East) Ahead Left | U | 3 | B | 2 | 3 |
| 4/1 | | U | 2 | | 2 | 3 |
| 5/1 | Development Road Right Left | U | 2 | C | 2 | 3 |
| 6/1 | | U | 1 | | 2 | 3 |

Full Input Data And Results

Give-Way Link Input Data

Lane Input Data

| Arm/ Lane | Link Num | Physical Length (PCU) | Expected Usage (PCU) | Sat Flow Type | User Saturation Flow (PCU/Hr) | Lane Width (m) | Gradient | Nearside Lane | Allowed Turns | Turni Radii (m) |
|--|--|-----------------------------|----------------------------|---------------------|--|----------------------|----------|------------------|------------------|-----------------------|
| 1/1 (Coventry Highway (West) Lane 1) | Link 1 (Coventry Highway (West) Ahead Right) | Inf | Inf | User | 1900 | 3.25 | 0.00 | Y | Arm 2 Ahead | Inf |
| 1/2 (Coventry Highway (West) Lane 2) | Link 1 (Coventry Highway (West) Ahead Right) | Inf | Inf | User | 1900 | 3.25 | 0.00 | Y | Arm 2 Ahead | Inf |
| 1/3 (Coventry Highway (West) Lane 3) | Link 1 (Coventry Highway (West) Ahead Right) | 5.0 | 6.0 | User | 1800 | 3.25 | 0.00 | Y | Arm 6 Right | Inf |
| 2/1 | Link 1 | Inf | Inf | Inf (Exit) | 1800 | 3.25 | 0.00 | Y | | |
| 2/2 | Link 1 | Inf | Inf | Inf (Exit) | 1800 | 3.25 | 0.00 | Y | | |
| 3/1 (Coventry Highway (East) Lane 1) | Link 1 (Coventry Highway (East) Ahead Left) | 5.0 | 6.0 | User | 1800 | 3.25 | 0.00 | Y | Arm 6 Left | Inf |
| 3/2 (Coventry Highway (East) Lane 2) | Link 1 (Coventry Highway (East) Ahead Left) | Inf | Inf | User | 1900 | 3.25 | 0.00 | Y | Arm 4 Ahead | Inf |
| 3/3 (Coventry Highway (East) Lane 3) | Link 1 (Coventry Highway (East) Ahead Left) | Inf | Inf | User | 1900 | 3.25 | 0.00 | Y | Arm 4 Ahead | Inf |
| 4/1 | Link 1 | Inf | Inf | Inf (Exit) | 1800 | 3.25 | 0.00 | Y | | |
| 4/2 | Link 1 | Inf | Inf | Inf (Exit) | 1800 | 3.25 | 0.00 | Y | | |
| 5/1 (Development Road Lane 1) | Link 1 (Development Road Right Left) | Inf | Inf | User | 1800 | 3.25 | 0.00 | Y | Arm 4 Left | Inf |
| 5/2 (Development Road Lane 2) | Link 1 (Development Road Right Left) | 5.0 | 5.0 | User | 1800 | 3.25 | 0.00 | Y | Arm 2 Right | Inf |
| 6/1 | Link 1 | Inf | Inf | Inf (Exit) | 1800 | 3.25 | 0.00 | Y | | |

Traffic Flow Groups

| Flow Group | Start Time | End Time | Duration | Formula |
|-------------------|------------|----------|----------|---------|
| 1: 'Am Peak 2017' | 08:00 | 09:00 | 01:00 | |
| 2: 'Pm Peak 2017' | 17:00 | 18:00 | 01:00 | |

Flow Group 1: 'Am Peak 2017'

Traffic Flow Matrix

Desired Flow :

| | Destination | | | | |
|--------|-------------|------|------|-----|------|
| | | A | B | C | Tot. |
| Origin | A | 0 | 1158 | 213 | 1371 |
| | B | 1082 | 0 | 197 | 1279 |
| | C | 21 | 19 | 0 | 40 |
| | Tot. | 1103 | 1177 | 410 | 2690 |

Link Traffic Flows

| Arm/Link | Flow Group 1: Am Peak 2017 |
|----------|----------------------------|
| 1/1 | 1371 |
| 2/1 | 1177 |
| 3/1 | 1279 |
| 4/1 | 1103 |
| 5/1 | 40 |
| 6/1 | 410 |

Lane Saturation Flows

| Arm/ Lane | Lane Width (m) | Gradient | Nearside Lane | Allowed Turns | Turning Radius (m) | Turning Prop. | Sat flow (PCU/Hr) |
|--|----------------------|----------|------------------|------------------|--------------------------|------------------|---|
| 1/1 (Coventry Highway (West) Lane 1) | | | | | | | This lane uses a directly entered Saturation Flow 1900 |
| 1/2 (Coventry Highway (West) Lane 2) | | | | | | | This lane uses a directly entered Saturation Flow 1900 |
| 1/3 (Coventry Highway (West) Lane 3) | | | | | | | This lane uses a directly entered Saturation Flow 1800 |
| 2/1 | | | | | | | Infinite Saturation Flow (on Exit Link) Inf |
| 2/2 | | | | | | | Infinite Saturation Flow (on Exit Link) Inf |
| 3/1 (Coventry Highway (East) Lane 1) | | | | | | | This lane uses a directly entered Saturation Flow 1800 |
| 3/2 (Coventry Highway (East) Lane 2) | | | | | | | This lane uses a directly entered Saturation Flow 1900 |
| 3/3 (Coventry Highway (East) Lane 3) | | | | | | | This lane uses a directly entered Saturation Flow 1900 |
| 4/1 | | | | | | | Infinite Saturation Flow (on Exit Link) Inf |
| 4/2 | | | | | | | Infinite Saturation Flow (on Exit Link) Inf |
| 5/1 (Development Road Lane 1) | | | | | | | This lane uses a directly entered Saturation Flow 1800 |
| 5/2 (Development Road Lane 2) | | | | | | | This lane uses a directly entered Saturation Flow 1800 |
| 6/1 | | | | | | | Infinite Saturation Flow (on Exit Link) Inf |

Flow Group 2: 'Pm Peak 2017'

Traffic Flow Matrix

Desired Flow :

| | Destination | | | | |
|--------|-------------|------|------|----|------|
| | | A | B | C | Tot. |
| Origin | A | 0 | 1108 | 27 | 1135 |
| | B | 926 | 0 | 23 | 949 |
| | C | 173 | 147 | 0 | 320 |
| | Tot. | 1099 | 1255 | 50 | 2404 |

Link Traffic Flows

| Arm/Link | Flow Group 2: Pm Peak 2017 |
|----------|----------------------------|
| 1/1 | 1135 |
| 2/1 | 1255 |
| 3/1 | 949 |
| 4/1 | 1099 |
| 5/1 | 320 |
| 6/1 | 50 |

Lane Saturation Flows

| Arm/Lane | Lane Width (m) | Gradient | Nearside Lane | Allowed Turns | Turning Radius (m) | Turning Prop. | Sat flow (PCU/Hr) |
|---|----------------|----------|---------------|---------------|--------------------|---------------|---|
| 1/1 (Coventry Highway (West) Lane 1) | | | | | | | This lane uses a directly entered Saturation Flow 1900 |
| 1/2 (Coventry Highway (West) Lane 2) | | | | | | | This lane uses a directly entered Saturation Flow 1900 |
| 1/3 (Coventry Highway (West) Lane 3) | | | | | | | This lane uses a directly entered Saturation Flow 1800 |
| 2/1 | | | | | | | Infinite Saturation Flow (on Exit Link) Inf |
| 2/2 | | | | | | | Infinite Saturation Flow (on Exit Link) Inf |
| 3/1 (Coventry Highway (East) Lane 1) | | | | | | | This lane uses a directly entered Saturation Flow 1800 |
| 3/2 (Coventry Highway (East) Lane 2) | | | | | | | This lane uses a directly entered Saturation Flow 1900 |
| 3/3 (Coventry Highway (East) Lane 3) | | | | | | | This lane uses a directly entered Saturation Flow 1900 |
| 4/1 | | | | | | | Infinite Saturation Flow (on Exit Link) Inf |
| 4/2 | | | | | | | Infinite Saturation Flow (on Exit Link) Inf |
| 5/1 (Development Road Lane 1) | | | | | | | This lane uses a directly entered Saturation Flow 1800 |
| 5/2 (Development Road Lane 2) | | | | | | | This lane uses a directly entered Saturation Flow 1800 |
| 6/1 | | | | | | | Infinite Saturation Flow (on Exit Link) Inf |

Scenario 1 : 'Scenario 1'

Staging Plan 1 : 'Staging Plan No. 1'

Flow Group 1 : 'Am Peak 2017'

Staging Plan Diagram

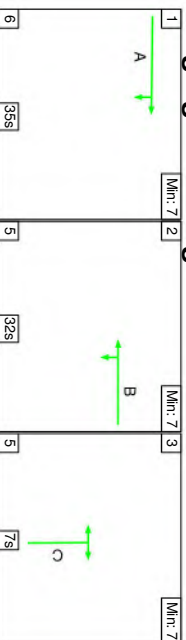

Stage Timings

| Stage | 1 | 2 | 3 |
|--------------|----|----|----|
| Duration | 35 | 32 | 7 |
| Change Point | 0 | 41 | 78 |

Signal Timings Diagram

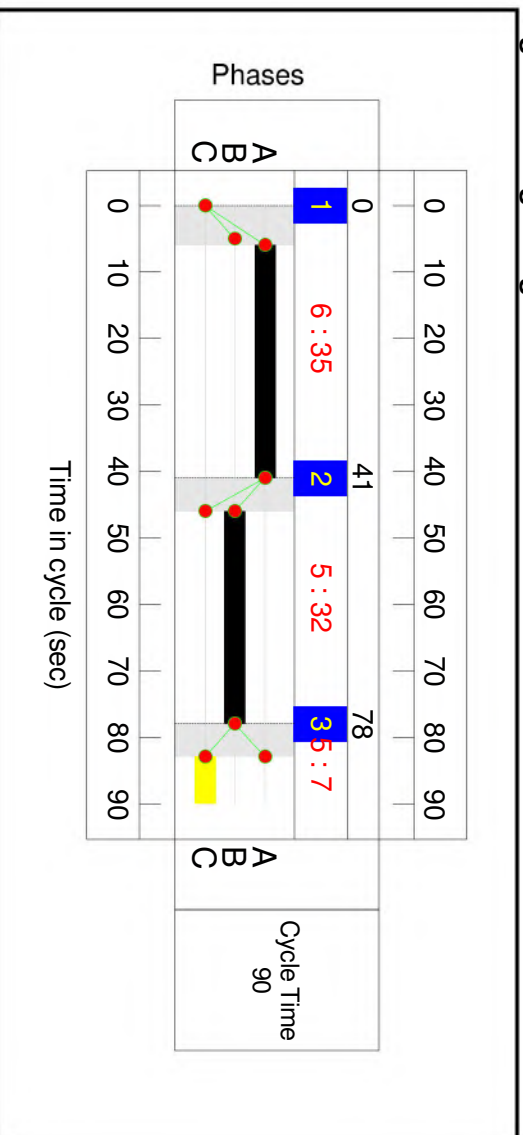

Full Input Data And Results

Junction Layout Diagram

Full Input Data And Results

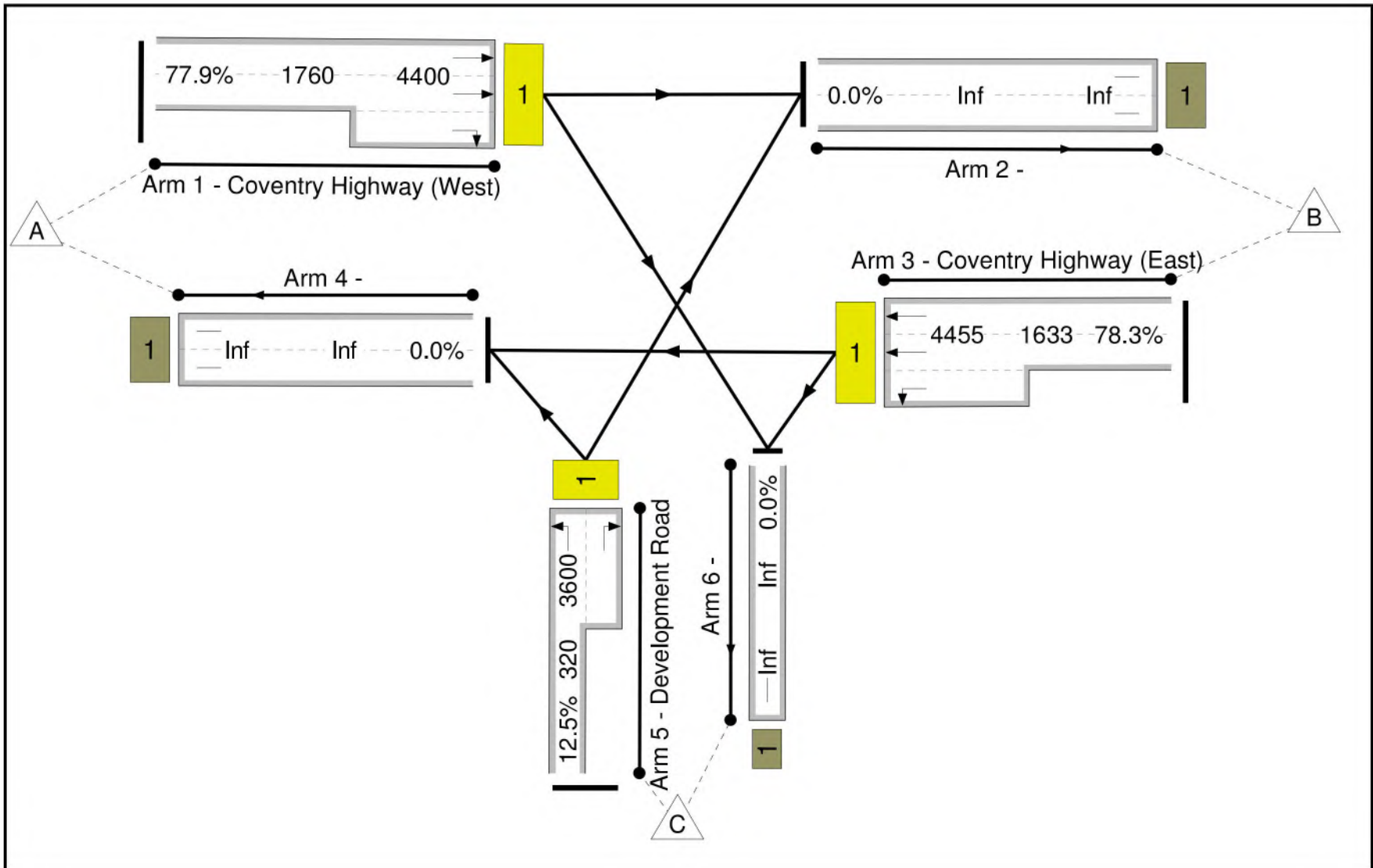

Full Input Data And Results

Link Results

| Link Num | Link Desc | Link Type | Stage Stream | Position In Filtered Route | Full Phase | Arrow Phase | Num Greens | Total Green (s) | Arrow Green (s) | Demand Flow (pcu) | Max Sat Flow (pcu/Hr) | Ave Sat Flow (pcu/Hr) | Capacity (pcu) | Deg Sat (%) |
|------------------------------|-------------------------------------|---------------|-----------------------|--|-----------------------------|-----------------------|------------------------------|------------------------------------|---------------------|---------------------------|----------------------------------|----------------------------|----------------------|-------------|
| 1/1 | Coventry Highway (West) Ahead Right | U | N/A | N/A | A | | 1 | 35 | - | 1371 | 5600 | 4400 | 1760 | 77.9 |
| 2/1 | | U | N/A | N/A | - | | - | - | - | 1177 | Inf | Inf | Inf | 0.0 |
| 3/1 | Coventry Highway (East) Ahead Left | U | N/A | N/A | B | | 1 | 32 | - | 1279 | 5600 | 4455 | 1633 | 78.3 |
| 4/1 | | U | N/A | N/A | - | | - | - | - | 1103 | Inf | Inf | Inf | 0.0 |
| 5/1 | Development Road Right Left | U | N/A | N/A | C | | 1 | 7 | - | 40 | 3600 | 3600 | 320 | 12.5 |
| 6/1 | | U | N/A | N/A | - | | - | - | - | 410 | Inf | Inf | Inf | 0.0 |
| Link Num | Entering (pcu) | Leaving (pcu) | Turners In Gaps (pcu) | Turners When Unopposed (pcu) | Turners In Intergreen (pcu) | Uniform Delay (pcuHr) | Rand + Oversat Delay (pcuHr) | Storage Area Uniform Delay (pcuHr) | Total Delay (pcuHr) | Av. Delay Per Veh (s/pcu) | Max. Back of Uniform Queue (pcu) | Rand + Oversat Queue (pcu) | Mean Max Queue (pcu) | |
| 1/1 | 1371 | 1371 | - | - | - | 8.3 | 1.7 | - | 10.1 | 26.4 | 28.6 | 1.7 | 30.3 | |
| 2/1 | 1177 | 1177 | - | - | - | 0.0 | 0.0 | - | 0.0 | 0.0 | 0.0 | 0.0 | 0.0 | |
| 3/1 | 1279 | 1279 | - | - | - | 8.4 | 1.8 | - | 10.2 | 28.7 | 27.4 | 1.8 | 29.1 | |
| 4/1 | 1103 | 1103 | - | - | - | 0.0 | 0.0 | - | 0.0 | 0.0 | 0.0 | 0.0 | 0.0 | |
| 5/1 | 40 | 40 | - | - | - | 0.4 | 0.1 | - | 0.5 | 44.2 | 0.9 | 0.1 | 1.0 | |
| 6/1 | 410 | 410 | - | - | - | 0.0 | 0.0 | - | 0.0 | 0.0 | 0.0 | 0.0 | 0.0 | |
| PRC for Signalled Links (%): | | | 14.9 | Total Delay for Signalled Links (pcuHr): | | | 20.77 | | | | | | | |
| PRC Over All Links (%): | | | 14.9 | Total Delay Over All Links(pcuHr): | | | 20.77 | Cycle Time (s): | | 90 | | | | |

Scenario 2: 'New Scenario'

Staging Plan 1: 'Staging Plan No. 1'

Flow Group 2: 'Pm Peak 2017'

Staging Plan Diagram

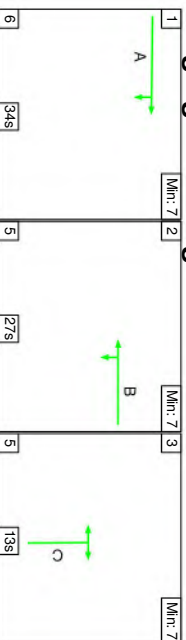

Stage Timings

| Stage | 1 | 2 | 3 |
|--------------|----|----|----|
| Duration | 34 | 27 | 13 |
| Change Point | 0 | 40 | 72 |

Signal Timings Diagram

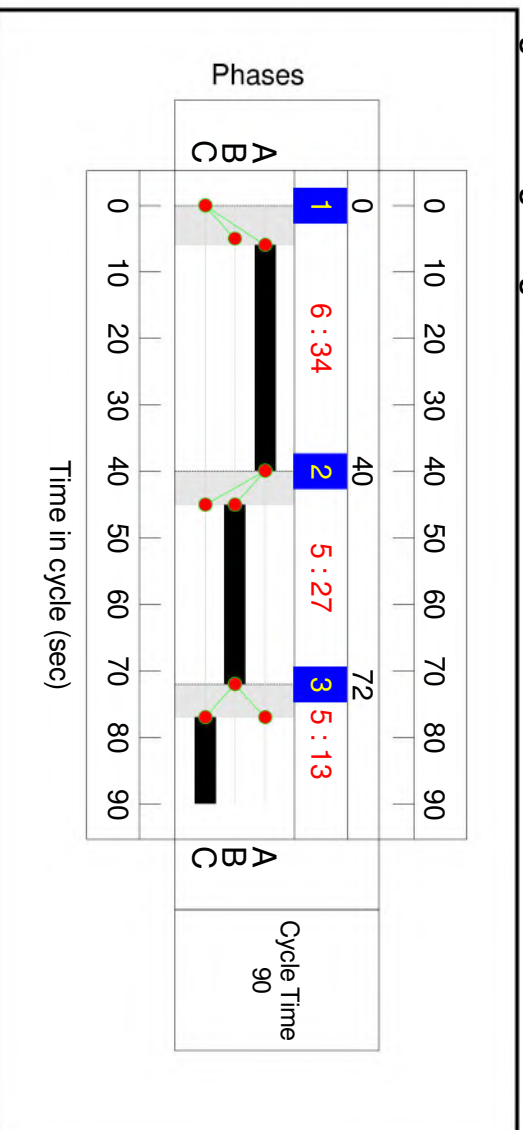

Full Input Data And Results

Junction Layout Diagram

Full Input Data And Results

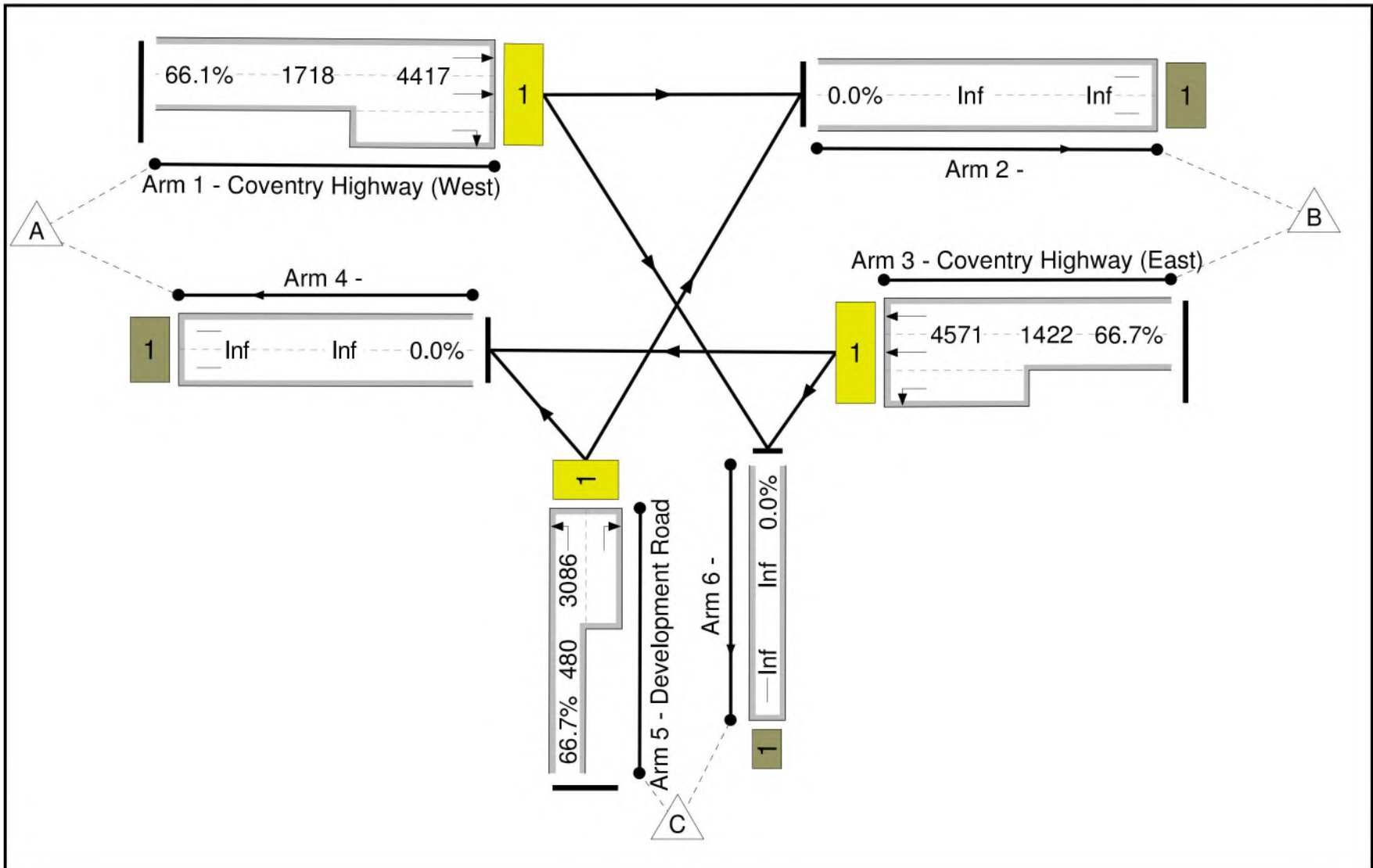

Full Input Data And Results

Link Results

| Link Num | Link Desc | Link Type | Stage Stream | Position In Filtered Route | Full Phase | Arrow Phase | Num Greens | Total Green (s) | Arrow Green (s) | Demand Flow (pcu) | Max Sat Flow (pcu/Hr) | Ave Sat Flow (pcu/Hr) | Capacity (pcu) | Deg Sat (%) |
|------------------------------|-------------------------------------|---------------|-----------------------|--|-----------------------------|-----------------------|------------------------------|------------------------------------|---------------------|---------------------------|----------------------------------|----------------------------|----------------------|-------------|
| 1/1 | Coventry Highway (West) Ahead Right | U | N/A | N/A | A | | 1 | 34 | - | 1135 | 5600 | 4417 | 1718 | 66.1 |
| 2/1 | | U | N/A | N/A | - | | - | - | - | 1255 | Inf | Inf | Inf | 0.0 |
| 3/1 | Coventry Highway (East) Ahead Left | U | N/A | N/A | B | | 1 | 27 | - | 949 | 5600 | 4571 | 1422 | 66.7 |
| 4/1 | | U | N/A | N/A | - | | - | - | - | 1099 | Inf | Inf | Inf | 0.0 |
| 5/1 | Development Road Right Left | U | N/A | N/A | C | | 1 | 13 | - | 320 | 3600 | 3086 | 480 | 66.7 |
| 6/1 | | U | N/A | N/A | - | | - | - | - | 50 | Inf | Inf | Inf | 0.0 |
| Link Num | Entering (pcu) | Leaving (pcu) | Turners In Gaps (pcu) | Turners When Unopposed (pcu) | Turners In Intergreen (pcu) | Uniform Delay (pcuHr) | Rand + Oversat Delay (pcuHr) | Storage Area Uniform Delay (pcuHr) | Total Delay (pcuHr) | Av. Delay Per Veh (s/pcu) | Max. Back of Uniform Queue (pcu) | Rand + Oversat Queue (pcu) | Mean Max Queue (pcu) | |
| 1/1 | 1135 | 1135 | - | - | - | 6.7 | 1.0 | - | 7.6 | 24.2 | 22.1 | 1.0 | 23.0 | |
| 2/1 | 1255 | 1255 | - | - | - | 0.0 | 0.0 | - | 0.0 | 0.0 | 0.0 | 0.0 | 0.0 | |
| 3/1 | 949 | 949 | - | - | - | 6.8 | 1.0 | - | 7.8 | 29.5 | 19.8 | 1.0 | 20.8 | |
| 4/1 | 1099 | 1099 | - | - | - | 0.0 | 0.0 | - | 0.0 | 0.0 | 0.0 | 0.0 | 0.0 | |
| 5/1 | 320 | 320 | - | - | - | 3.1 | 1.0 | - | 4.1 | 46.3 | 7.4 | 1.0 | 8.4 | |
| 6/1 | 50 | 50 | - | - | - | 0.0 | 0.0 | - | 0.0 | 0.0 | 0.0 | 0.0 | 0.0 | |
| PRC for Signalled Links (%): | | | 34.9 | Total Delay for Signalled Links (pcuHr): | | | 19.53 | | | | | | | |
| PRC Over All Links (%): | | | 34.9 | Total Delay Over All Links(pcuHr): | | | 19.53 | Cycle Time (s): 90 | | | | | | |



Copyright © Morgan Tucker
DO NOT SCALE. USE FIGURED DIMENSIONS ONLY.
CHECK ON SITE AND REPORT ALL DISCREPANCIES TO
MORGAN TUCKER.

| | | |
|---|-------------|------------|
| Rev | Description | Date |
| | | |
|  ALMA Commerce and Technology Centre, Wessons Road, Newark Nottinghamshire, NG24 1SU Tel: 01636 610 766 Fax: 01636 610 766 E-Mail: info@morgantucker.co.uk www.morgantucker.co.uk | | |
| Redditch Borough Council | | |
| Proposed Diversification Park Development | | |
| Proposed Access Arrangements | | |
| Scale | Sheet No. | Access No. |
| 1:500 | 100 | 05 |
| Date | Drawn | Rev |
| 24/09/09 | MTS | 01 |
| Drawn | Information | Rev |
| | | |
| JN835 - NWK - 011 | | |

Reproduced by permission of Ordnance Survey on behalf of
HM/SO © Crown Copyright 2006. All rights reserved.
Ordnance Survey Licence number 100046211

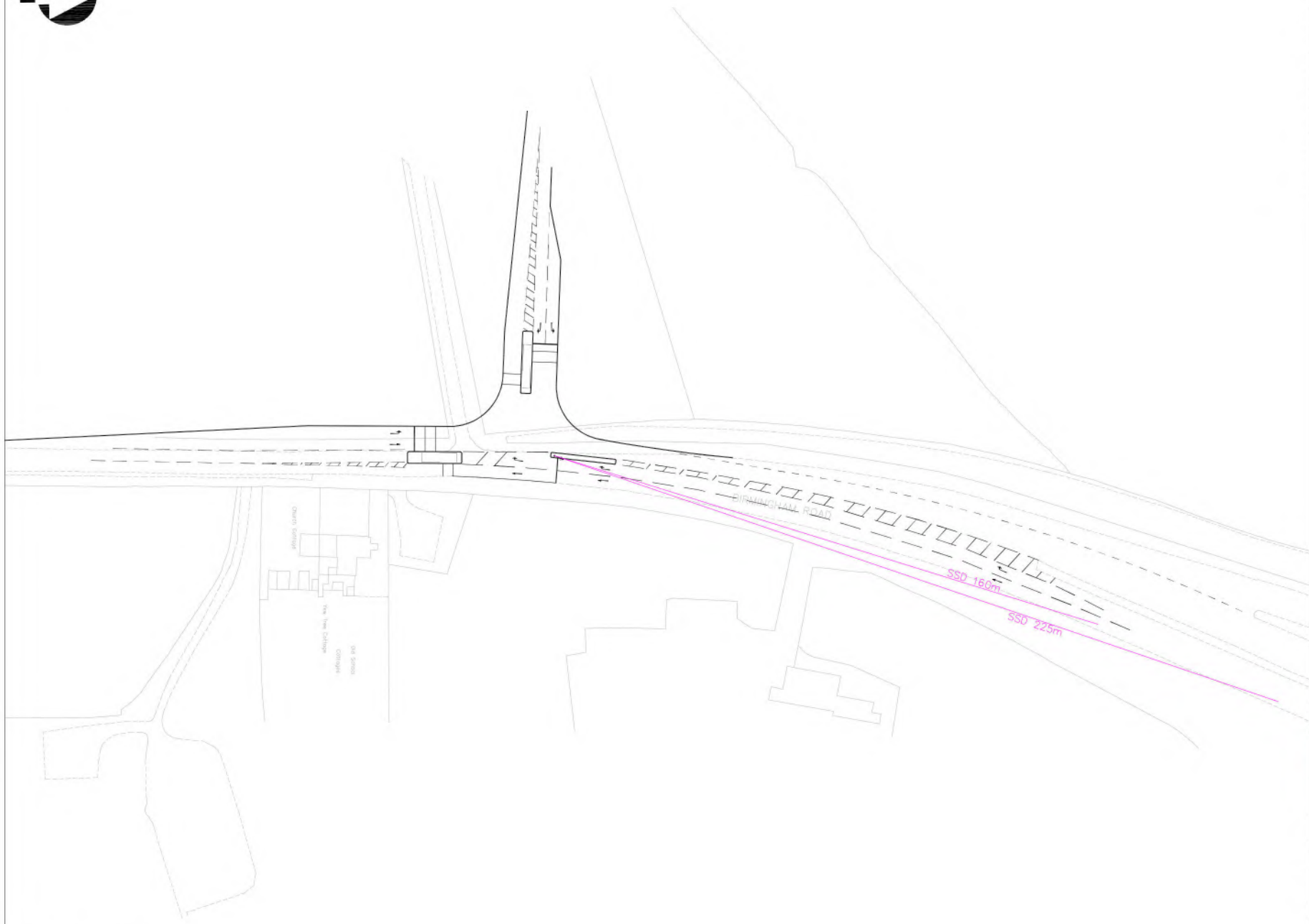

Copyright © Morgan Tucker
DO NOT SCALE, USE FIGURED DIMENSIONS ONLY.
CHECK ON SITE AND REPORT ALL DISCREPANCIES TO
MORGAN TUCKER.

Notes:
Drawing is based on Ordnance Survey mapping and has been produced for discussion and comparison purposes only.
Forward visibility of the junction for south bound traffic is restricted by the bend in Birmingham Road. Stopping Sight Distance is shown for 60mph and 50mph. It is assumed that both cross over highway verge although the 215m SSD may be restricted by trees. It is recommended that a topographical survey is undertaken to ascertain the extents of the highway and any restrictions to forward visibility.
Detailed Design should be undertaken using the actual 85%ile speed of traffic

| | | |
|---|---|-------|
| 1 | Local authority to be consulted on proposed | 10/10 |
| 2 | Highway authority to be consulted | 0/100 |
| 3 | Other | 0/0 |

MT morgan tucker
civil & highway
ALMA Commerce and Technology Centre, Messers Road, Nuneaton
Warwickshire, CV23 7BU
Tel: 01828 610 766 Fax: 01828 610 766
E-Mail: info@morgantucker.co.uk
www.morgantucker.co.uk

| | |
|-------------|--------------------------------------|
| Client: | Redditch Borough Council |
| Location: | Wylates Green Triangle |
| Project No: | Proposed Junction Birmingham Road |
| Scale: | Sheet No. 1 of 1 |
| Date: | 07 September 2020 |
| Drawn by: | 1:500 |
| Checked by: | |
| Project No: | JN835/NWK/012 |
| Rev: | A |

Reproduced by permission of Ordnance Survey on behalf of
HMISO © Crown Copyright 2006. All rights reserved.
Ordnance Survey Licence number 100046211

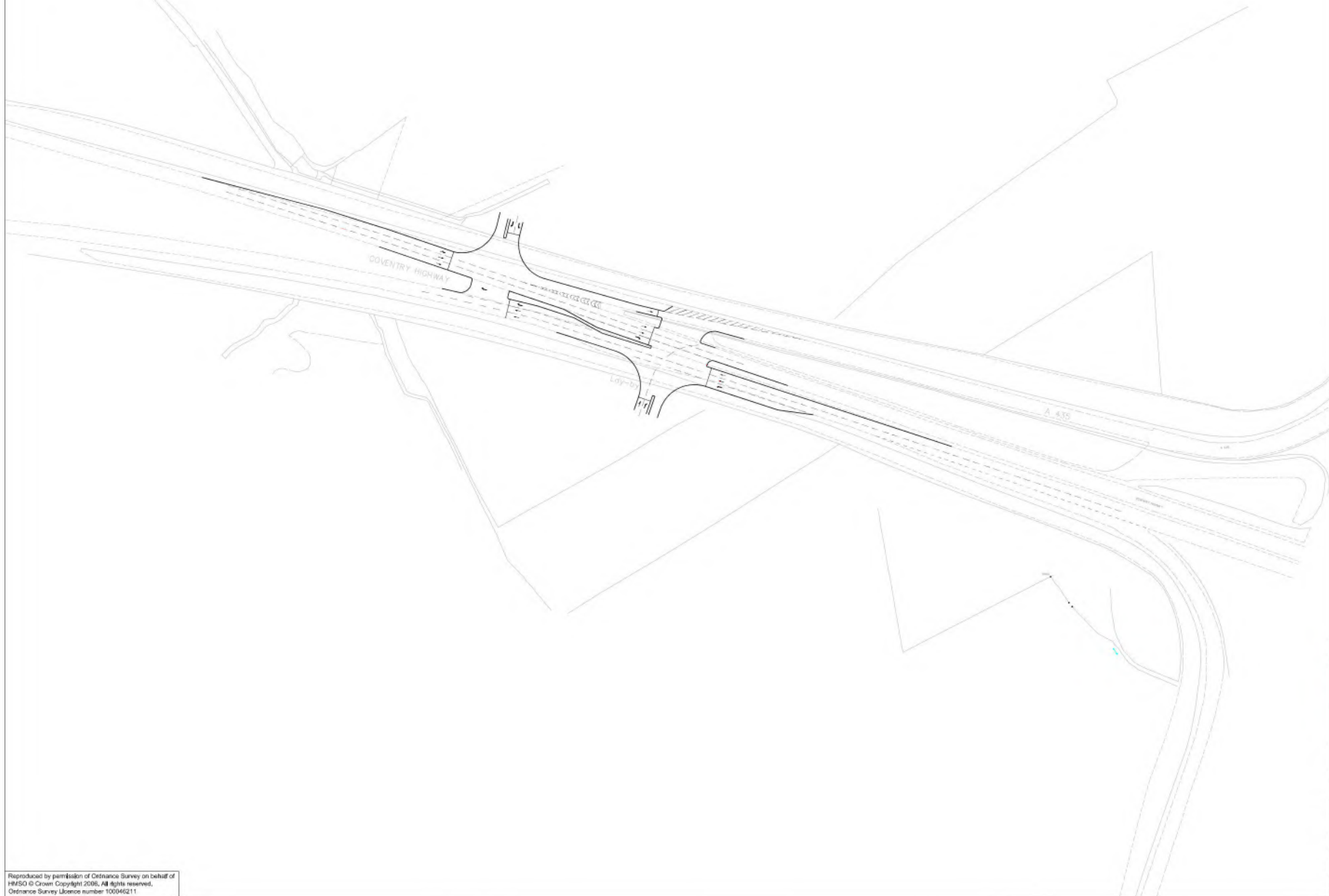

Copyright © Morgan Tucker
DO NOT SCALE. USE FIGURED DIMENSIONS ONLY.
CHECK ON SITE AND REPORT ALL DISCREPANCIES TO
MORGAN TUCKER.

| | | | |
|---|-------------------|-------|--------|
| Scale | As shown | Unit | mm |
| | | | |
| ALMA Commerce and Technology Centre, Manors Road, North Walsingham, NE21 3SU Tel: 01636 610 766 Fax: 01636 610 766 E-Mail: info@morgantucker.co.uk www.morgantucker.co.uk | | | |
| Client Redditch Borough Council | | | |
| Project Wylates Green Triangle | | | |
| Project Title Coventry Highway Proposed Junction | | | |
| Scale | 1:100 | Scale | 1:100 |
| Date | 07 September 2025 | Scale | 1:1000 |
| Drawing No. JN835/NWK/013 | | | |

Reproduced by permission of Ordnance Survey on behalf of
HM/SO © Crown Copyright 2006. All rights reserved.
Ordnance Survey Licence number 100046211